

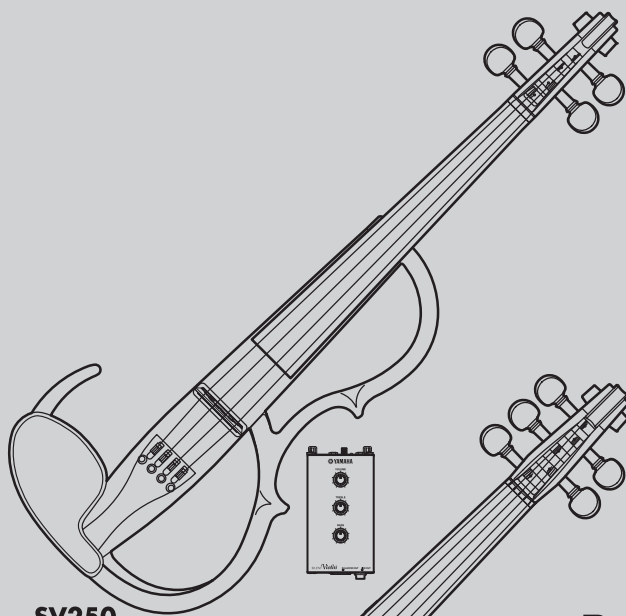

SILENT *Violin*TM

SV250/SV255



SV250

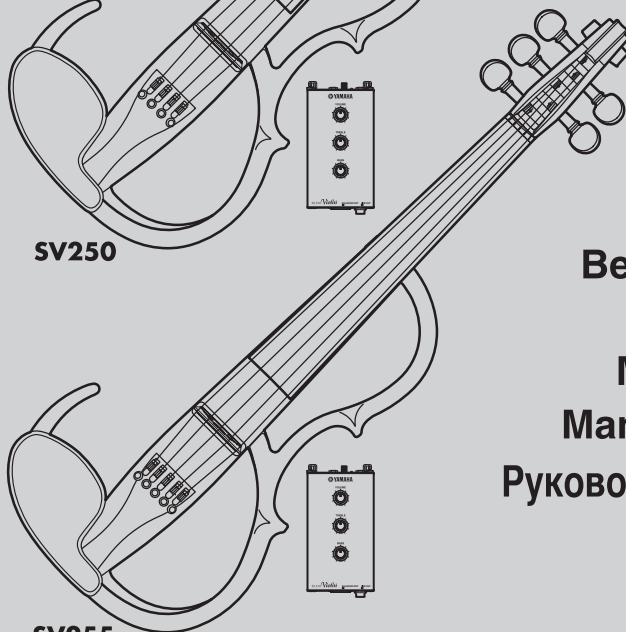

SV255

取扱説明書

Owner's Manual

Bedienungsanleitung

Mode d'emploi

Manuale dell'utente

Manual del propietario

Руководство пользователя

使用手冊

사용설명서

日本語

English

Deutsch

Français

Italiano

Español

Русский

中文

한국어

Thank you for purchasing the Yamaha SILENT Violin[™]. In order to obtain the maximum performance and enjoyment from your SILENT Violin[™], we urge you to read this Owner's Manual thoroughly before using the instrument. Please keep this Owner's Manual in a safe place for later reference.

■ SV250/255 Features

The SV250/SV255 SILENT Violin[™] is a high quality electric violin designed for stage and studio use.

Based on the same slim body design found in previous SILENT Violins[™], the SV250/255 incorporates a unique hollow structure in its body to deliver enhanced acoustic tone and excellent playability.

The SV250/255 features a dual pickup design using one piezo-electric pickup located underneath the bridge to reproduce the rich acoustic tone produced by the overall instrument, and another newly developed piezo-electric pickup built into the bridge to accurately reproduce subtle bowing nuances. Output from the two pickups can be blended freely to create a wide range of tone. The instrument's electronics are housed in a sturdy aluminum control box that can be placed on the floor or attached to the player's apparel with its integral belt clip. The unit supplies the violin's preamp with its needed electric power and incorporates an equalizer for shaping the tone of the instrument's audio signal. It also includes a headphone monitor amp with independently adjustable volume and the unit can be powered from any one of three power sources; two AA batteries, a power adaptor, or phantom power.

In addition to a regular monaural line out, an XLR balanced output provides a noise resistant balanced output signal for sending the instrument's output directly to a mixing console. The two outputs let you easily connect to an effector/amp system and mixing console at the same time, or connect to a DAW via an audio interface for recording.

Crafted with high quality woods, quality construction and finish, plus electronics designed specifically for the violin and diverse output options, the SV250/255 goes beyond being a great instrument for practice to being an instrument perfect for stage and recording use with its exceptional tone quality and playability.

SPECIAL MESSAGE SECTION

This product utilizes batteries or an external power supply (adaptor). DO NOT connect this product to any power supply or adaptor other than one described in the manual, on the name plate, or specifically recommended by Yamaha.

This product should be used only with the components supplied or; a cart, rack, or stand that is recommended by Yamaha. If a cart, etc., is used, please observe all safety markings and instructions that accompany the accessory product.

SPECIFICATIONS SUBJECT TO CHANGE: The information contained in this manual is believed to be correct at the time of printing. However, Yamaha reserves the right to change or modify any of the specifications without notice or obligation to update existing units.

Do not attempt to service this product beyond that described in the user-maintenance instructions. All other servicing should be referred to qualified service personnel.

This product, either alone or in combination with an amplifier and headphones or speaker/s, may be capable of producing sound levels that could cause permanent hearing loss. DO NOT operate for long periods of time at a high volume level or at a level that is uncomfortable. If you experience any hearing loss or ringing in the ears, you should consult an audiologist.

IMPORTANT: The louder the sound, the shorter the time period before damage occurs.

NOTICE: Service charges incurred due to a lack of knowledge relating to how a function or effect works (when the unit is operating as designed) are not covered by the manufacturer's warranty, and are therefore the owner's responsibility. Please study this manual carefully and consult your dealer before requesting service.

ENVIRONMENTAL ISSUES: Yamaha strives to produce products that are both user safe and environmentally friendly. We sincerely believe that our products and the production methods used to produce them meet these goals. In keeping with both the letter and the spirit of the law, we want you to be aware of the following:

Battery Notice: This product MAY contain a small non-rechargeable battery which (if applicable) is soldered in place. The average life span of this type of battery is approximately five years. When replacement becomes necessary, contact a qualified service representative to perform the replacement.

This product may also use "household" type batteries. Some of these may be rechargeable. Make sure that the battery being charged is a rechargeable type and that the charger is intended for the battery being charged.

When installing batteries, do not mix old batteries with new, or with batteries of a different type. Batteries MUST be installed correctly. Mismatches or incorrect installation may result in overheating and battery case rupture.

Warning: Do not attempt to disassemble or incinerate any battery. Keep all batteries away from children. Dispose of used batteries promptly and as regulated by the laws in your area. Note: Check with any retailer of household type batteries in your area for battery disposal information.

Disposal Notice: Should this product become damaged beyond repair, or for some reason its useful life is considered to be at an end, please observe all local, state, and federal regulations that relate to the disposal of products that contain lead, batteries, plastics, etc. If your dealer is unable to assist you, please contact Yamaha directly.

NAMEPLATE LOCATION: The nameplate is located on the bottom of the product. The model number, serial number, power requirements, etc., are located on this plate. You should record the model number, serial number, and the date of purchase in the spaces provided below and retain this manual as a permanent record of your purchase.

Model Serial No.

Purchase Date

92-2P

PLEASE KEEP THIS MANUAL

FCC INFORMATION (U.S.A.)

1. IMPORTANT NOTICE: DO NOT MODIFY THIS UNIT!

This product, when installed as indicated in the instructions contained in this manual, meets FCC requirements. Modifications not expressly approved by Yamaha may void your authority, granted by the FCC, to use the product.

2. IMPORTANT:

When connecting this product to accessories and/or another product use only high-quality shielded cables. Cable/s supplied with this product MUST be used. Follow all installation instructions. Failure to follow instructions could void your FCC authorization to use this product in the USA.

3. NOTE:

This product has been tested and found to comply with the requirements listed in FCC Regulations, Part 15 for Class "B" digital devices. Compliance with these requirements provides a reasonable level of assurance that your use of this product in a residential environment will not result in harmful interference with other electronic devices. This equipment generates/uses radio frequencies and, if not installed and used according to the instructions found in the user's manual, may cause interference harmful to the operation of other elec-

tronic devices. Compliance with FCC regulations does not guarantee that interference will not occur in all installations. If this product is found to be the source of interference, which can be determined by turning the unit "OFF" and "ON", please try to eliminate the problem by using one of the following measures:

Relocate either this product or the device that is being affected by the interference.

Utilize power outlets that are on different branch (circuit breaker or fuse) circuits or install AC line filter/s.

In the case of radio or TV interference, relocate/reorient the antenna. If the antenna lead-in is 300 ohm ribbon lead, change the lead-in to co-axial type cable.

If these corrective measures do not produce satisfactory results, please contact the local retailer authorized to distribute this type of product. If you cannot locate the appropriate retailer, please contact Yamaha Corporation of America, Electronic Service Division, 6600 Orangethorpe Ave, Buena Park, CA 90620

The above statements apply ONLY to those products distributed by Yamaha Corporation of America or its subsidiaries.

CANADA

THIS DIGITAL APPARATUS DOES NOT EXCEED THE "CLASS B" LIMITS FOR RADIO NOISE EMISSIONS FROM DIGITAL APPARATUS SET OUT IN THE RADIO INTERFERENCE REGULATION OF THE CANADIAN DEPARTMENT OF COMMUNICATIONS.

LE PRESENT APPAREIL NUMERIQUE N'EMET PAS DE BRUITS RADIOELECTRIQUES DEPASSANT LES LIMITES APPLICABLES AUX APPAREILS NUMERIQUES DE LA "CLASSE B" PRESCRITES DANS LE REGLEMENT SUR LE BROUILLAGE RADIOELECTRIQUE EDICTE PAR LE MINISTRE DES COMMUNICATIONS DU CANADA.

- This applies only to products distributed by Yamaha Canada Music Ltd.
- Ceci ne s'applique qu'aux produits distribués par Yamaha Canada Musique Ltée.

Your SILENT Violin™ will give you years of reliable service if you follow the simple rules given below:

■ Location

Do not expose it to the following conditions to avoid deformation, discoloration, or more serious damage.

- Direct sunlight (e.g. near a window).
- High temperatures (e.g. near a heat source, outside, or in a car during the daytime).
- Excessive humidity.
- Excessive dust.
- Strong vibration.

■ Power Supply

- Turn the power switch OFF when not in use.
- If you use an AC power adaptor, unplug the adaptor from the AC outlet if not to be used for an extended period of time.
- Unplug the AC power adaptor during electric storms.
- Avoid plugging the AC power adaptor into the same AC outlet as appliances with high power consumption, such as electric heaters or ovens. Also avoid using multi-plug adaptors since these can result in reduced sound quality and possibly damage.

■ Turn Power OFF When Making Connections

- To avoid damage to the SILENT Violin™ and other devices to which it is connected (a sound system, for example), turn the power switches of all related devices OFF prior to connecting or disconnecting audio cables.

■ Handling and Transport

- Never apply excessive force to the controls, connectors or other parts.
- Always unplug cables by gripping the plug firmly, not by pulling on the cable.
- Disconnect all cables before moving the unit.
- Physical shocks caused by dropping, bumping, or placing heavy objects on the unit can result in scratches and more serious damage.

■ Cleaning

- Clean the cabinet and panel with a dry soft cloth.
- A slightly damp cloth may be used to remove stubborn grime and dirt.
- Never use cleaners such as alcohol or thinner.
- Avoid placing vinyl objects on top of the unit (vinyl can stick to and discolor the surface).

■ Electrical Interference

- This unit contains electric circuitry and may cause interference if placed too close to radio or television receivers. If this occurs, move it further away from the affected equipment.

Yamaha is not responsible for damage caused by improper handling or operation.

Information for Users on Collection and Disposal of Old Equipment and used Batteries



These symbols on the products, packaging, and/or accompanying documents mean that used electrical and electronic products and batteries should not be mixed with general household waste. For proper treatment, recovery and recycling of old products and used batteries, please take them to applicable collection points, in accordance with your national legislation and the Directives 2002/96/EC and 2006/66/EC.

By disposing of these products and batteries correctly, you will help to save valuable resources and prevent any potential negative effects on human health and the environment which could otherwise arise from inappropriate waste handling.

For more information about collection and recycling of old products and batteries, please contact your local municipality, your waste disposal service or the point of sale where you purchased the items.

[For business users in the European Union]

If you wish to discard electrical and electronic equipment, please contact your dealer or supplier for further information.

[Information on Disposal in other Countries outside the European Union]

These symbols are only valid in the European Union. If you wish to discard these items, please contact your local authorities or dealer and ask for the correct method of disposal.

Note for the battery symbol (bottom two symbol examples):

This symbol might be used in combination with a chemical symbol. In this case it complies with the requirement set by the Directive for the chemical involved.



Cd

Main Body/Accessories

After opening the packaging, please check that all the parts listed below are included.

- Main Unit x 1

(The instrument ships from the factory with its bridge lying flat.)

[SV250]

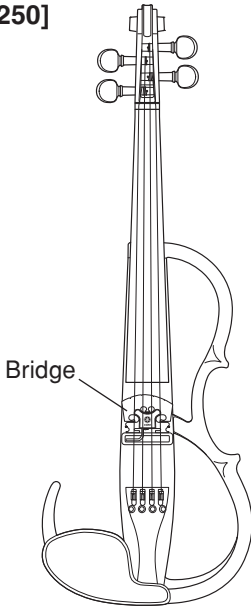

[SV255]

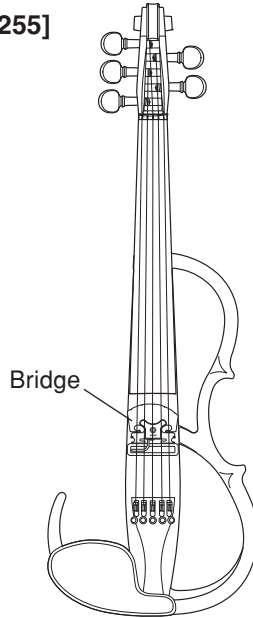

- Control Box x 1

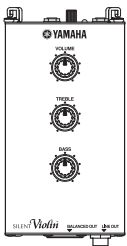

- Cable x 1

(Connects the instrument to the Control Box.)

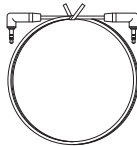

- Cable Band x 2

(Secures the cable to the instrument body.)

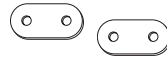

- Stereo earphones x 1



- Owner's Manual (this booklet) x 1

* Use an optional Yamaha Power Adaptor (see page 15) for powering the instrument with a power adaptor.

* To play SV250/SV255, you will need 2 SUM-3 (AA) size batteries.

Nomenclature

[Main Unit]

● Front

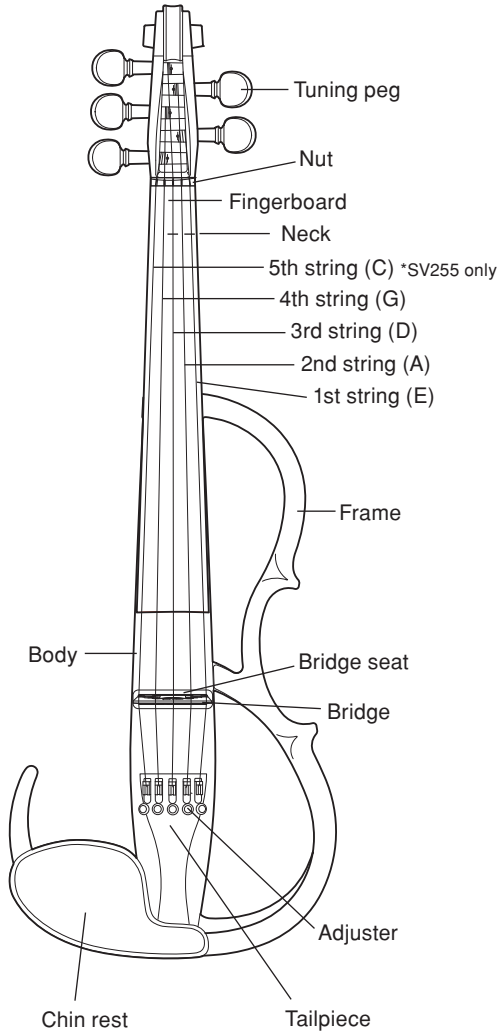

● Back

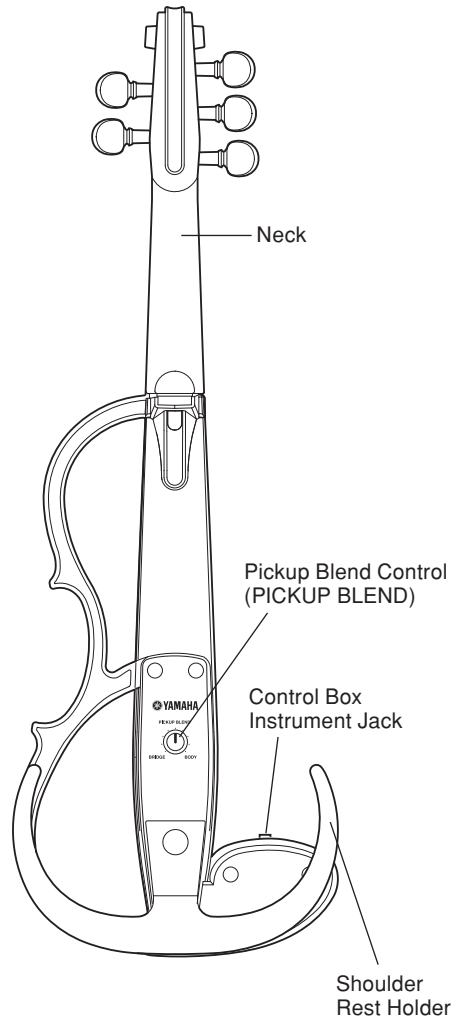

The SV255 is used in the diagram.

[Control Box]

* For use with the SV250/SV255. Not compatible with other instruments.

Stereo Earphones

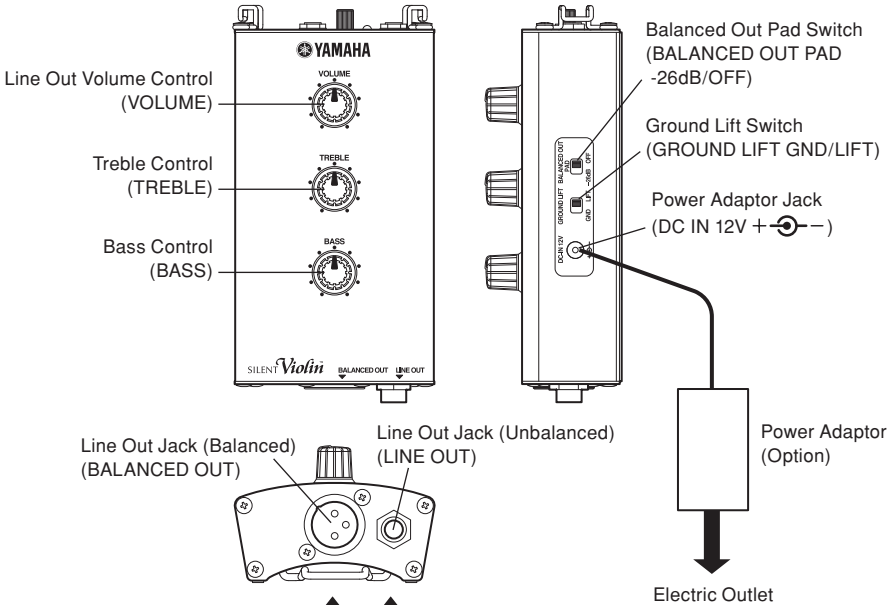
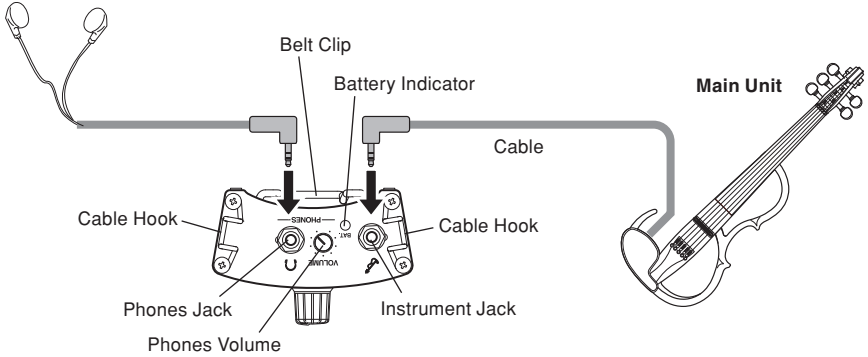

Connect to a balanced input (XLR connector) on a mixing console, audio interface, or similar external device.

Connect to the input (standard 1/4" phone jack) on a powered speaker, effector, or similar external device.

[Explanation of Input/Output Section]

<On the Instrument>

① Control Box Instrument Jack

This jack is used to receive power from the Control Box and transmit the audio signal from the instrument to the Control Box. Use the supplied cable to connect the instrument to the “Instrument Jack” on the Control Box.

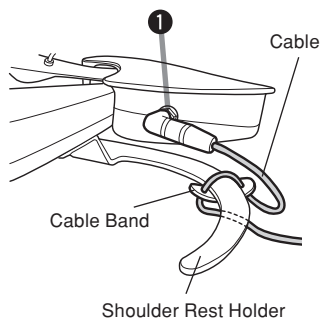

* A commercially available audio cable with stereo mini plugs on both ends can also be used. (Cables with resistors are not compatible.)

* The system will not operate properly if a monaural cable is used.

* The system will not operate properly if the cable is attached to anything other than the Control Box.

* Pass the cable end through the holes on the supplied cable band then attach to the shoulder rest as shown in the diagram on the right to prevent accidental disconnecting of the cable.

Caution

- Disconnecting the cable while the power is ON may result in damage to the equipment. The sudden shock to your ears may be severe, so please use caution.
- When connecting or disconnecting the cable, always make sure that the control box is not connected to any external device, or that the power is switched OFF on the external device before proceeding. The resulting loud sound may cause hearing loss and damage external equipment.
- When connecting or disconnecting the cable, always make sure there are no inner earphones or headphones, etc., connected. The loud sound may cause hearing loss and damage the inner earphones or headphones.

<On the Control Box>

② Instrument Jack (🔌)

This jack supplies power to the SV250/SV255 instrument and receives the audio signal from the SV250/SV255. Use the supplied cable to connect the instrument to the “Instrument Jack” on the Control Box.

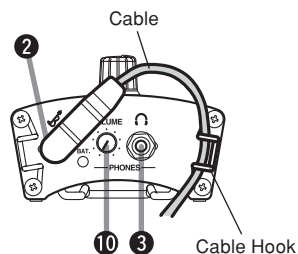

* The control box's main power is switched ON when a cable is connected to this jack.

* Hooking the cable onto the cable hook positioned furthest away from the instrument jack prevents accidental disconnection of the cable.

Caution

- Always disconnect the cable when the instrument is not in use. The instrument continuously consumes electric power when the cable is connected.
- When connecting or disconnecting the cable, always make sure that the control box is not connected to any external device, or that the power is switched OFF on the external device before proceeding. The resulting loud sound may cause hearing loss and damage external equipment.
- When connecting or disconnecting the cable, always make sure there are no inner earphones or headphones, etc., connected. The loud sound may cause hearing loss and damage the inner earphones or headphones.
- Never connect any devices (including other SILENT Violins™ with different model numbers) other than the SV250/SV255 SILENT Violin™ that is included in the bundled set. Doing so may result in damage to the other device.

3 Phones Jack (🎧)

For connecting the supplied inner earphones.

- * The headphone amp's power is switched ON when a pair of stereo inner earphones is connected to this jack.
- * The volume level for the stereo inner earphones can be adjusted with the 10 PHONES VOLUME control adjacent to the PHONES jack. Since the 10 PHONES VOLUME is not linked to the MAIN VOLUME control, its level can be adjusted independently of the LINE OUT.
- * Any commercially available headphones or inner earphones can be used.

Caution

- Always disconnect the headphones or inner earphones from the jack when the instrument is not being used. The device continuously consumes power when a cable is connected to the jack. Also, switching the power on when nothing is connected to this jack deactivates the headphone amp decreasing power consumption to increase battery life.
- Never disconnect the headphones or inner earphones while the headphones or inner earphones are still in your ears. The resulting loud sound may cause hearing loss.
- Do not listen for extended periods of time at loud volume levels using the inner earphones or headphones. Doing so can result in damage to your hearing.

4 Line Out Jack (Unbalanced) (LINE OUT)

The line out jack is compatible with a standard 1/4" phone plug. The signal is delivered from this output after being adjusted with the volume, treble, and bass controls.

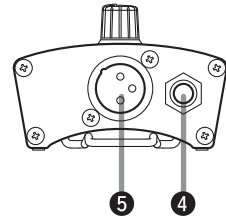

5 Line Out Jack (Balanced) (BALANCED OUT)

The balanced output jack is compatible with an XLR connector. This jack delivers a balanced signal that is the same as the LINE OUT jack (adjusted with volume, treble, and bass controls).

The signal can be attenuated by 26dB using the BALANCED OUT PAD switch on the side of the control box.

Caution

- Make sure that the power is switched OFF or all volume levels are set to "0" on all external equipment before connecting external equipment to the Line Out Jack (Unbalanced, Balanced). Loud volume levels can damage your hearing, and damage equipment.
- When making connections to external devices, make sure that the proper plugs are used and securely connected.
- If the sound is distorted, use the volume control on the instrument or on the Control Box and lower the volume until the sound is no longer distorted.

[Control Section Details]

<On the Instrument>

⑥ Pickup Blend Control (PICKUP BLEND)

Controls the volume balance between the two built-in pickups. The line out jack is compatible with a standard ¼" phone plug. Rotate the knob fully to the right [BODY] to produce the signal from the pickup underneath the bridge, which reproduces the rich tone produced by the instrument's body. Rotate the knob fully to the left [BRIDGE] to produce the signal from the pickup in the bridge, which reproduces bow articulation and quicker response. Set the dial to its center position to produce a balanced output of the two pickups.

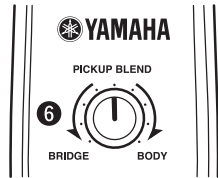

* The volume control is not located on the instrument itself, use the volume control on the control box to adjust the volume.

<On the Control Box>

⑦ Line Out Volume Control (VOLUME)

Adjusts the volume level of the signal delivered from the LINE OUT and BALANCED OUT jacks. (It does not effect the volume of the Phones jack.)

⑧ Treble Control (TREBLE)

Adjusts the treble or high range frequencies. (Effects all output)

⑨ Bass Control (BASS)

Adjusts the bass or low range frequencies. (Effects all output)

⑩ Phones Volume (see diagram on page 7)

Adjusts the volume level of the Phones jack signal. (This volume can be set regardless of the main volume control setting.)

* If the electric output sound is distorted, lower the VOLUME and other such controls to a suitable level.

⑪ Ground Lift Switch (GROUND LIFT GND/LIFT)

Separates the ground between the instrument and external device when connecting the instrument to an external device via the BALANCED OUT XLR connector. The [GND] setting is used under normal circumstances. If you experience noise due to a ground loop, move the switch to the [LIFT] position to separate the ground between the instrument and external device. This is one method that can be used to suppress noise.

* When the switch is set to the [LIFT] position, the instrument will not operate with phantom power (Refer to page 11). Use batteries or a power adaptor.

⑫ Balanced Out Pad Switch (BALANCED OUT PAD -26dB/OFF)

Attenuates the signal from the BALANCED OUT jack by 26dB.

Setting this switch to the [-26dB] position when connecting the instrument to a small mixing console or other device that only has balanced XLR mic level inputs makes its output compatible with a mic level input.

To connect the instrument to a line level balanced input on an external device, set the switch to the [OFF] position to send the same level signal as that of the unbalanced LINE OUT.

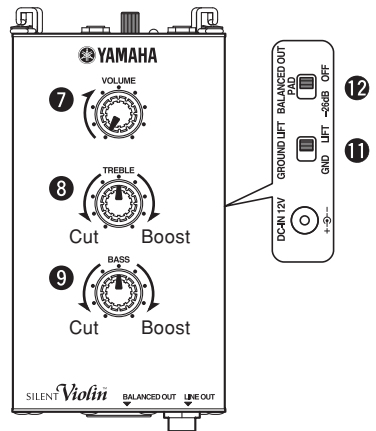

Power Supply

The SV250/255 can operate on power supplied from three different power sources; battery power, AC power, or phantom power supplied by an external source via the XLR cable. Always make sure that the power is switched OFF on the external audio device, or its volume is set to “0” before switching the instrument’s power ON.

■ Using Batteries

- 1 Open the battery compartment cover on the backside of the control box.
- 2 Insert the two batteries (SUM-3 (AA) size). Take careful note of the polarity markings as shown in the illustration above, and insert the batteries.
- 3 Replace the battery compartment cover.

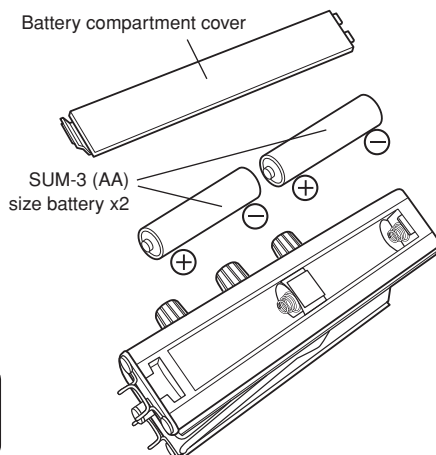

* For customers in the Netherlands

Bij dit produkt zijn batterijen geleverd. Wanneer deze leeg zijn, moet u ze niet weggooien maar inleveren als KCA.



About the Battery Warning Indicator (LED)

The Battery Warning Indicator located to the right of the instrument jack on the control box, is usually off during normal operation however, it will change from blinking to continuously lit as battery power depletes. When the indicator starts blinking, follow the cautions below and change the batteries as soon as possible.

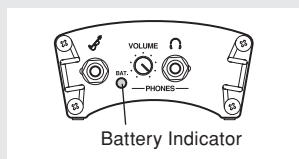

- Always follow the +/- signs when inserting the batteries. Improper insertion may result in fire.
- Always replace worn batteries with a complete set of new batteries. Never mix new and old batteries. Do not mix different types of batteries (alkaline and manganese, or batteries from different manufacturers, or different types by the same manufacturer). Doing so may result in fire.
- To prevent possible damage to the unit due to battery leakage and unnecessary power drain, remove the batteries from the unit when it is not going to be used for an extended period of time.

The warning indicator blinks once when connecting a cable to the jack if the batteries have an adequate charge or the power adaptor is operating properly. (When operating on phantom power alone, the light will not flash when connecting a cable due to the control box design.)

■ Supplying AC Power

AC adaptor is optional, please purchase the optional power adaptor (Refer to page 15).

- 1 Securely connect the power adaptor's DC connector to the DC IN jack on the side of the Control Box.
- 2 Plug the AC adaptor into a convenient wall AC power socket.

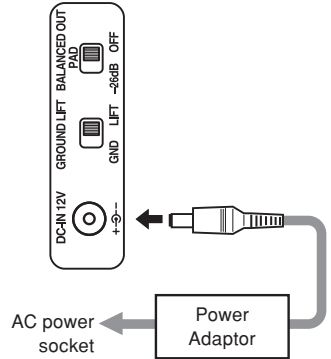

■ When Using Phantom Power

- 1 Use an XLR cable to connect the balanced out jack on the instrument to a mixer or other external audio device that can supply phantom power (48V).
- 2 Switch on the phantom power on the external device.

- * Due to the supply limitations of phantom power, there is not enough power to drive the headphone amp, so only the amp for the line out jack and balanced out jack is operational regardless of whether a pair of inner earphones is connected to the PHONES jack or not. (There is no output from the PHONES jack.)
- * When the instrument is powered using both phantom power and the power adaptor, the headphone amplifier will operate since power supply priority is given to the power adaptor.
- * The priority given to power use is power adaptor → phantom power → battery power, power is not drawn from the battery when the power adaptor or phantom power is used.

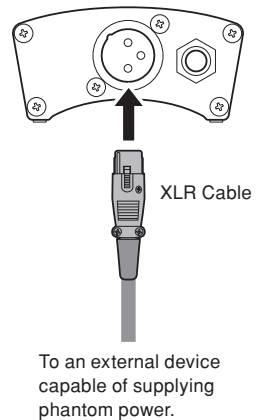

Set up

■ Tuning and Changing the Strings

Because the bridge includes a built in sensor, which is connected to the body with a thin cable, the instrument ships from the factory with the bridge laying down. First, set up the bridge and then proceed with tuning. As the strings get old, sound quality will gradually decrease, and it will become difficult to tune the instrument. Change the strings as soon as you think they are getting old.

Caution

- The end of the strings are sharp and can cut fingers. Use caution when changing strings.
- When changing or adjusting strings, do not put your face close to the instrument. The string may suddenly break resulting in eye or other unexpected injuries.

- The lower side of the bridge supports the 1st string (E), the higher side supports the 4th string (G)/5th string (C). Make sure the bridge is placed properly, then set the bridge in the bridge seat.
- Ensure that the bridge stands vertically. If it leans to one side, use both hands to adjust. Make sure that each string passes over the corresponding slits in the bridge.

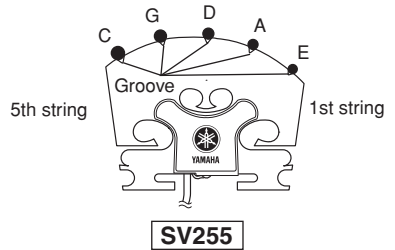
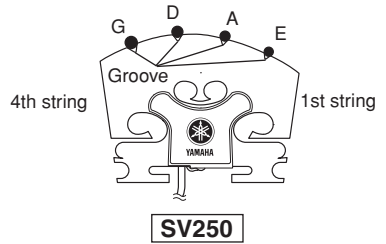
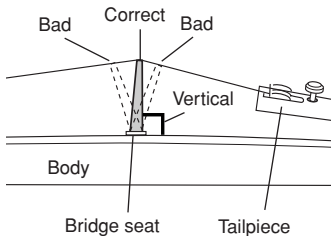

[Looking from the tailpiece]

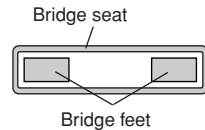

[Make sure the bridge feet do not come in contact with the bridge seat]

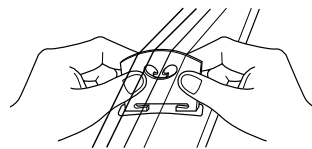

[Bridge is placed vertically]

Caution

Make sure that the strings are resting in their appropriate grooves in the bridge when playing the instrument.

Strings may come out of their grooves when adjusting the bridge or changing strings. Since the 1st (E) and 4th (G)/5th (C) strings tend to come out of their grooves easily, use your fingers to hold the strings gently in place when tuning the instrument.

Also, the 1st (E) string is fitted with a protective tube. Make sure that the tube rests on the bridge.

Always make sure that the bridge is standing vertically, whether the instrument is being played or stored. (see diagram on page 12)

Even if the bridge is standing vertically before tuning, it may tilt during the tuning process. If so, readjust the bridge so it stands vertically.

It is very important that the bridge stands vertically. If it leans in either direction it will impair the sound and risk damaging the instrument.

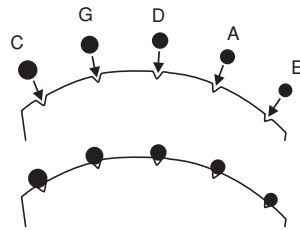

[Make sure that the strings do not come out of their grooves]

Protective tube on the 1st (E) string

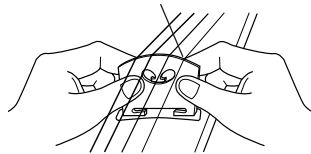

[Bridge is placed vertically]

- String tunings are, 1st string E, 2nd string A, 3rd string D, 4th string G, 5th string C (SV255 only). Push in on the tuning peg and rotate to tune. Use a piano, tuning fork, or tuner to tune the instrument.
- Finally, use the adjuster to fine tune the strings.

Caution

If the adjuster is too loose, it could produce noise while playing.

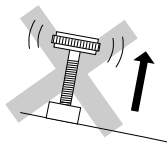

Don't loosen too much.

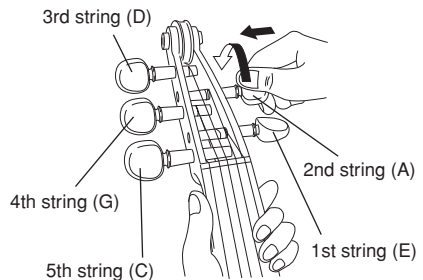

SV255

- When the instrument is not going to be used for an extended period of time, loosen the strings until the pitch drops a whole tone.
- Before using the instrument, make sure that the bridge is positioned vertically. Damage to the bridge and poor sound quality may result if the bridge is not properly positioned.

● Winding the Strings

(Please refer to this section when changing the strings)

- 1 Before you string the instrument, set the adjuster so that it is in the middle of its adjustment range. (All adjusters)
- 2 Place the ball (on the end of the string) in the notch on the adjuster. Make sure the ball is properly inserted in the adjuster's notch.

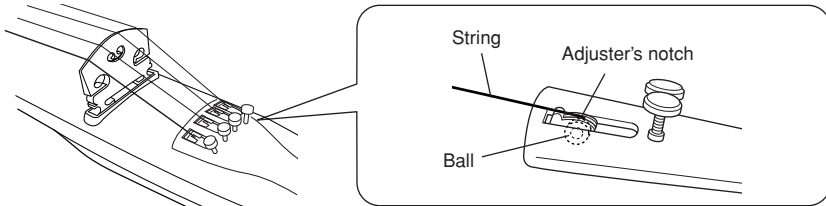
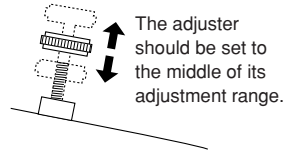

- 3 After threading the string through the hole in the tuning peg, turn the tuning peg making one wrap on one side of the hole and the remaining wraps on the other side as shown in the diagram on the right.

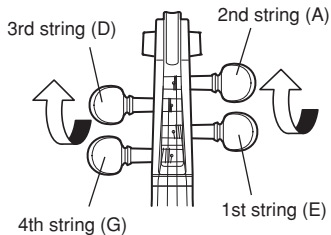
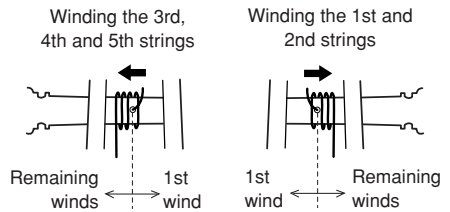

SV250

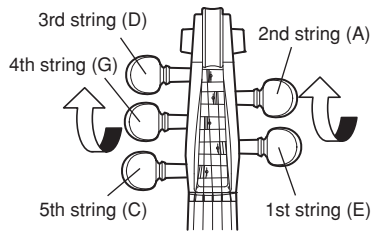

SV255

■ The Shoulder Rest

A commercially available violin shoulder rest (4/4 size) can be attached to the instrument.

* Some shoulder rests are incompatible (air cushion type, etc.).

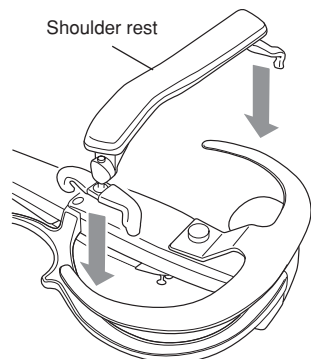

Specifications

Instrument

Neck	Maple
Body	Spruce/Maple
Fingerboard/Tuning Pegs	Ebony
Bridge	Maple (Built-in Sensor Type)
Frame	Synthetic Resin
Tailpiece	SV250 : Adjuster : 4 pieces (Wittner) SV255 : Adjuster : 5 pieces (Wittner)
Strings	Ball-end type violin strings (Zyex) * Helicore on the 5-string SV255 only
Sensor	Piezo pick-up (underneath the bridge), Bridge w/ Built-in Piezo-electric Pickup
Power	Supplied via the Control Box connection
String Length	328 mm (12-15/16")
Dimensions	SV250 : 591 (L) x 206 (W) x 117 (H) mm 23-1/4" (L) x 8-1/8" (W) x 4-5/8" (H) SV255 : 600 (L) x 206 (W) x 122 (H) mm 23-5/8" (L) x 8-1/8" (W) x 4-13/16" (H)
Weight (instrument only)	SV250 : approximately 500 g (1 lbs. 2 oz.) SV255 : approximately 540 g (1 lbs. 3 oz.)
Control	Pickup Blend

Control Box

Case	Aluminum Alloy
Controls	<ul style="list-style-type: none">• Line Out Volume• Treble Control• Bass Control• Phones Volume• Ground Lift Switch• Balanced Out Pad Switch
Connections	<ul style="list-style-type: none">• Instrument Jack (Input/Output with Built-in Power Switch)• Phones Jack (Output, PHONES with Built-in Amp Power Switch)• Line Out Jack (LINE OUT) (6.3mm Unbalanced Output)• Line Out Jack (BALANCED OUT) (XLR Balanced Output)• Power Adaptor Jack (DCIN12V)
Power	<ul style="list-style-type: none">• Batteries: SUM-3 (AA) size battery x2• Power Adaptor (sold separately): Yamaha PA3C (for use in Japan), PA130 (for use internationally), DC 12 V/700 mA 
Power Consumption	<ul style="list-style-type: none">• Phantom Power: 28-48V2.6 W (with the PA3C), 1.1 W (with the PA130, PA130A), 1.2 W (with the PA130B)
Battery Life (Continuous Use)	Using Manganese batteries : When Using Earphones: approx. 15 hours, Without: approx. 45 hours Using Alkaline batteries : When Using Earphones: approx. 50 hours, Without: approx. 120 hours
Dimensions (excluding the buttons)	142 (L) x 72 (W) x 49 (H) mm
Weight	5-9/16" (L) x 2-13/16" (W) x 1-15/16" (H) approximately 260 g (9 oz.) (without supplied batteries)

Accessories

Cable, Stereo earphones, Owner's Manual (this booklet)

* Design and specifications are subject to change without notice.

