

# **YAMAHA**

The logo for the Yamaha DXS synthesizer. It features the letters 'DXS' in a stylized, outlined font. The 'D' is formed by multiple horizontal lines of varying lengths, creating a sense of motion or digital data. The 'X' and 'S' are solid outlines.

**DIGITAL PROGRAMMABLE ALGORITHM SYNTHESIZER  
SYNTHÉTISEUR NUMÉRIQUE À ALGORITHMES  
PROGRAMMABLES**

**DIGITAL PROGRAMMIERBARER ALGORITHMUS  
SYNTHESIZER**

**OWNER'S MANUAL  
MODE D'EMPLOI  
BEDIENUNGSANLEITUNG**

---

---

# **CONGRATULATIONS!**

---

---

You have acquired one of the world's finest digital synthesizers! Your DX5 incorporates the Yamaha exclusive digital FM voice generation system which can be programmed to produce the most vibrant, dynamic, natural-sounding voices of any synthesizer system available--128 pre-programmed voices are provided with your DX5, but you can program any number of your own voices and store them on optional RAM data cartridges. Two FM voice generator channels are provided which you can use individually, combined, or in the split keyboard mode. The DX5 offers more than just spectacular voices, however, it also has one of the most comprehensive performance effect systems available. In addition to the common pitch and modulation wheels, you have keyboard initial touch response, after touch response, foot controller and Yamaha's unique breath controller (foot controller and breath controller are options). Each of these controllers can be programmed to produce an extremely broad variety of effects, many of which are simply not achievable with conventional synthesizer systems. What's more the DX5 has a special performance memory which can store up to 64 combinations of voices and performance effect parameters, so all you need to do is press a button to call out a voice or voice combination, each with its own unique set of performance parameters. The DX5 is also equipped with a MIDI interface, permitting it to communicate and be used with other MIDI compatible products to create a state-of-the art digital music system.

The Yamaha DX5 is a sophisticated, fully professional performance or recording keyboard. To get the most out of the many features it offers, we urge you to read this operation manual thoroughly, then store it in a safe place for later reference.

---

---

# CONTENTS

---

---

<b>PRECAUTIONS</b> .....	3
<b>CHAPTER I: SETTING UP</b> .....	4
1. Audio outputs .....	4
2. Foot controllers and footswitches .....	4
3. Headphones/breath controller .....	4
4. MIDI terminals .....	5
5. AC power .....	5
6. Music rack installation .....	5
<b>CHAPTER II: VOICE AND PERFORMANCE MEMORY</b>	
<b>CONFIGURATION</b> .....	7
1. Voice memory configuration .....	7
2. External cartridge voice memory .....	7
3. Performance memory configuration .....	9
4. The voice and performance edit buffers .....	9
<b>CHAPTER III: PLAYING THE PREPROGRAMMED VOICES</b> .....	10
1. Internal/Cartridge Voice Memory Selection .....	10
2. Key Assign Mode Selection .....	10
3. Voice Balancing .....	11
4. Voice Selection .....	11
5. The LCD Display .....	11
<b>CHAPTER IV: PLAYING THE PERFORMANCE COMBINATIONS</b> .....	13
1. Performance Memory Selection .....	13
2. Calling the Performance Name .....	14
3. Accessing a Performance Cartridge .....	14
<b>CHAPTER V: FUNCTION PROGRAMMING</b> .....	15
1. Function "Job" Organization .....	15
2. The FUNCTION mode: Accessing the Function Jobs .....	15
3. Entering Function Data .....	16
4. The Performance Functions and Their Use .....	17
<b>CHAPTER VI: PROGRAMMING VOICES</b> .....	26
1. The Basics of FM Synthesis .....	26
2. The EDIT and COMPARE Modes .....	32
3. The Voice Parameters .....	32
4. Two Approaches to Creating Your Own Voices .....	41
<b>CHAPTER VII: STORING VOICE AND PERFORMANCE DATA</b> .....	42
<b>CHAPTER VIII: MEMORY MANAGEMENT</b> .....	45
<b>CHAPTER IX: MIDI FUNCTIONS</b> .....	51
<b>CHAPTER X: GENERAL SPECIFICATIONS</b> .....	55

---

---

# **PRECAUTIONS**

---

---

---

---

## **1. Location**

Choose the installation location for the DX5 with caution. Avoid locations exposed to direct sunlight or other sources of heat. Also avoid locations subject to vibration, excessive dust, cold or moisture.

---

---

## **2. Cleaning**

Do not attempt to clean the exterior with chemical solvents, as this may damage the finish. Clean with a soft, dry cloth.

---

---

## **3. Service and Modifications**

Do not open the cabinet or attempt to make your own repairs or modifications to any part of the instrument. Such actions may not only result in electrical shock or damage, but will also void the product warranty. Refer all servicing to a qualified Yamaha service center.

---

---

## **4. Relocation**

When moving the instrument be sure to unplug the AC mains cord as well as all other connecting cables.

---

---

## **5. Handling**

Avoid applying excessive force to switches and slide controls, dropping or rough handling. The DX5 is ruggedly constructed using reliable solid-state circuitry, nonetheless it is a fine instrument that should be treated with care.

---

---

## **6. Electrical Storms (Lightning)**

Digital circuitry such as that used in the DX5 is sensitive to voltage spikes and surges. Because of this, the DX5 should be turned off and unplugged from the AC power outlet in the event of an electrical storm.

---

---

## **7. Electromagnetic Fields**

Digital circuitry is also sensitive to electromagnetic fields such as those produced by television sets, radio receivers, transmitters, transceivers, etc. The DX5 should be kept at least several feet from such sources in order to prevent possible random malfunctions.

---

# CHAPTER 1: SETTING UP

---

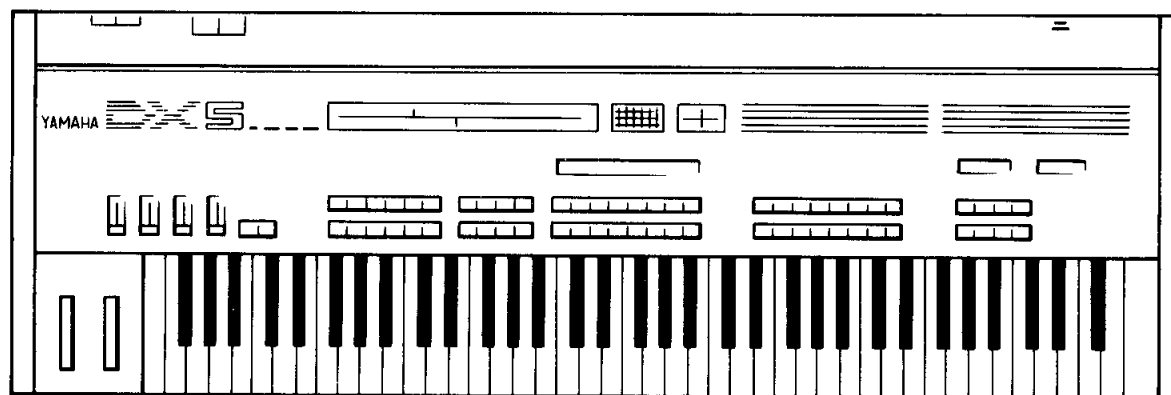

---

## 1. Audio Outputs

The DX5 gives you a choice of audio outputs for compatibility with the widest possible variety of sound reproduction systems. There are six audio outputs, three of which are unbalanced 1/4" phone jacks, and three are balanced XLR type connectors. The three phone jacks carry the same signals as the XLR outputs, the only difference in their use is the type of sound system they will be connected to. The phone jacks provide compatibility with most keyboard or instrument amplifiers and small mixers, while the XLR outputs can be used to feed professional sound reinforcement or recording equipment.

The three phone/XLR connector pairs are labelled A, B and P. Outputs A and B are the independent audio outputs from the DX5's corresponding A and B voice channels. P (for Program) delivers a monaural mix of both channels A and B. If, for example, you will be using the DX5 with a simple instrument amplifier which only has one input, then use the combined P output. If a mixing console is available, however, the A and B outputs can be sent to different input channels on the mixer, where they can be independently controlled and assigned to different channels of a stereo sound system, for example.

---

## 2. Foot Controllers and Footswitches

The remaining four phone jacks are for optional foot controllers and footswitches. The VOLUME jack accepts a Yamaha FC7 foot controller for volume or "swell" control. The MODULATION jack also accepts a Yamaha FC7 foot controller or equivalent for modulation control (The DX5 permits a wide variety of modulation effects). The SUSTAIN jack accepts a Yamaha FC4 or 5 footswitch or equivalent for sustain control—press for sustain, release to damp. And the PORTAMENTO jack also accepts a Yamaha FC4 or 5 footswitch or equivalent permitting ON/OFF switching of the programmed portamento effect.

---

## 3. Headphones/ Breath Controller

For convenience, the DX5's headphones and breath controller jacks are located just below the left side of the keyboard, facing the player. The stereo headphone output also features a level control which can be used to set the most comfortable headphone monitoring level without affecting the level of the other audio outputs. Any standard pair of 8-ohm stereo headphones can be used.

---

## **4. MIDI Terminals**

These terminals are used when connecting the DX5 to other MIDI (Musical Instrument Digital Interface) compatible equipment such as digital sequence recorders, modular FM voice generators, drum machines, etc. The MIDI OUT terminal transmits MIDI data from the DX5 to other MIDI equipment. The MIDI OUT terminal will normally be connected to the MIDI IN terminal of the receiving equipment. The MIDI IN terminal receives MIDI data from external MIDI equipment such as a digital sequence recorder, music computer or modular FM voice generator. The DX5's MIDI IN terminal will normally be connected to the MIDI OUT terminal of the transmitting equipment. The MIDI THRU terminal re-transmits the data received at the MIDI IN terminal. Thus, data received via the DX5 MIDI IN terminal can be simultaneously sent to other MIDI equipment.

---

## **5. AC Power**

Plug the socket end of the supplied AC power cord into the receptacle provided on the DX5 rear panel, then plug the plug end into an AC wall socket. Be sure that your local line voltage matches that specified on the DX5 rear panel. The POWER switch is located next to the AC cord receptacle on the rear panel.

### **NOTE:**

When setting up your system, be sure to turn the DX5 and any effects units used on **BEFORE** turning the main amplifier system on. This will prevent the initial power-on shock surge from possibly damaging your amplifier and speaker system.

---

## **6. Music Rack Installation**

The music rack supplied with the DX5 fits into the two sockets on the rear panel (see diagram).

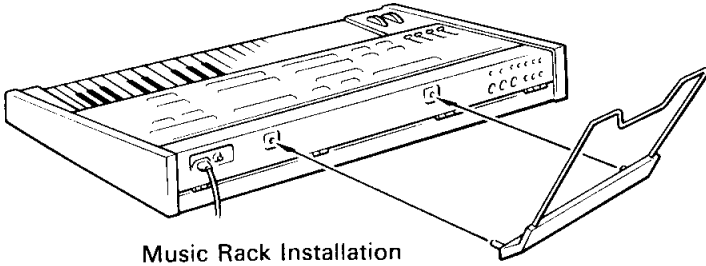

Music Rack Installation

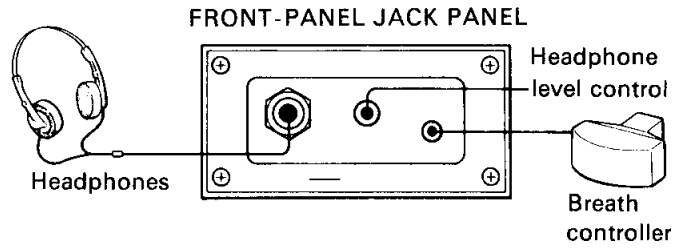

VOLUME foot control    MODULATION foot control    SUSTAIN footswitch    PORTAMENTO footswitch

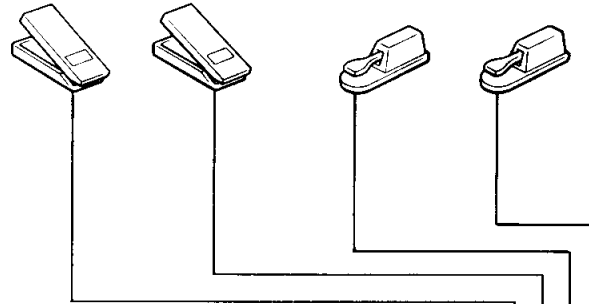
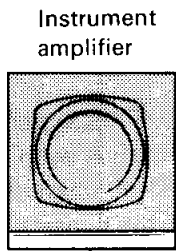

Sound reinforcement or recording mixer

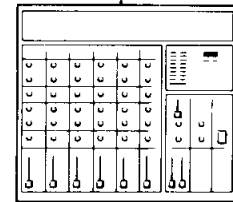

---

---

## **CHAPTER II: VOICE AND PERFORMANCE MEMORY CONFIGURATION**

---

---

Before you actually begin playing the pre-programmed voices, it's a good idea to understand how the voice and performance memories are arranged. So let's take a look at the DX5 memory configuration and then go on and try out the voices as described in the following chapter.

---

### **1. Voice Memory Configuration**

The DX5 internal voice memory is arranged in four banks of 8 voices per channel. The channels--A and B--correspond to independent voice generators, so any of the 32 voices available in channel A or B (4 banks x 8 voices = 32 voices) can be used independently, or simultaneously with any of the 32 voices available in the other channel. All 64 internal voice memories contain factory programmed voices which can be later edited or entirely re-programmed. These voices are also provided in the ROM voice cartridges supplied.

---

### **2. External Cartridge Voice Memory**

The DX5 further permits selection of its internal voice memory or external cartridge voice memory. Voice cartridges plugged into the CARTRIDGE A and CARTRIDGE B slots on the DX5 panel supply an additional 32 voices per channel which are selected in the same way as the internal voices. This gives the player a total of 128 voices "on-line" (64 internal + 64 external), which can be called simply by pressing a few buttons.

The DX5 is supplied with two ROM voice cartridges, each containing two banks of 32 voices (bank I x 32 voices + bank II x 32 voices = 64 voices per cartridge). The cartridge voice bank to be used is selected by a switch on the cartridge. The voices in banks I of the two cartridges are the same as those pre-programmed into the DX5's internal memory.



# DX5 PERFORMANCES & VOICES

GROUP	No.	PERFORMANCE ROM		VOICE ROM A		VOICE ROM B	
		No.	NAME	No.	NAME	No.	NAME
BRASS	1	1-1	DOUBLE HORN SECTION (DETUNED)	I 1-1	HORN SEC. A	I 1-1	HORN SEC. B
	2	1-2	FANFARE TRUMPETS	1-2	TRUMPET A	1-2	TRUMPET B
	3	1-3	FULL SYNTH BRASS (DETUNED)	1-3	SYN BRS 1A	1-3	SYN BRS 1B
	4	1-4	TIGHT BRASS SECTION	1-4	TIGHT BR. A	1-4	TIGHT BR. B
	5	1-5	SYNTH BRASS	1-5	SYN BRS 2A	1-5	SYN BRS 2B
	6	1-6	SYNTH BRASS [F/C CHORUS]	1-6	SYN BRS 3A	1-6	SYN BRS 3B
	7	1-7	CS80 BRASS [F/C VIBRATO]	1-7	CS80 BRS A	1-7	CS80 BRS B
	8	1-8	STRINGS & BRASS ENSEMBLE	1-8	BRIGHT ST.	1-8	BRASS
STRING	9	2-1	CELLO QUARTET	I 2-1	CELLOS 1A	I 2-1	CELLOS B
	10	2-2	VIOLIN ENSEMBLE	2-2	VIOLINS A	2-2	VIOLINS 1B
	11	2-3	ENSEMBLE [L]/SOLO VIOLIN [R]	2-3	ST. ENS. 1A	2-3	SOLOVIOLIN
	12	2-4	STRING ORCHESTRA	2-4	MID STRG A	2-4	MID. STRG B
	13	2-5	HIGH STRINGS (ANALOG TYPE)	2-5	AN. STRG A	2-5	AN. STRG B
	14	2-6	CELLOS & VIOLINS	2-6	CELLOS 2A	2-6	VIOLINS 2B
	15	2-7	STRING ENSEMBLE [F/C VIBRATO]	2-7	ST. ENS. 2A	2-7	ST. ENS. B
	16	2-8	STRINGS & VELOCITY TRUMPETS	2-8	STRINGS A	2-8	TRUMPET B
KEYBOARD & PERCUSSIVE	17	3-1	ACOUSTIC GRAND PIANO 1	I 3-1	PIANO 1A	I 3-1	PIANO 1B
	18	3-2	ACOUSTIC GRAND PIANO 2	3-2	PIANO 2A	3-2	PIANO 2B
	19	3-3	ELECTRIC GRAND PIANO	3-3	ELEC GRD A	3-3	ELEC GRD B
	20	3-4	ELECTRIC PIANO [M/W TREMOLO]	3-4	E. PIANO 1A	3-4	E. PIANO 1B
	21	3-5	ELECTRIC PIANO (BRIGHT TINE)	3-5	E. PIANO 2A	3-5	E. PIANO 2B
	22	3-6	DIRTY ELECTRIC PIANO	3-6	E. PIANO 3A	3-6	E. PIANO 3B
	23	3-7	CLAV. ENSEMBLE	3-7	CLAV. A	3-7	CLAV. 1B
	24	3-8	GRAND HARPSICHORD	3-8	HARPSI. 1A	3-8	HARPSI. B
	25	4-1	PIPE ORGAN [F/C VIBRATO]	I 4-1	PIPES A	I 4-1	PIPES B
	26	4-2	JAZZ ORGAN [F/C TREMOLO]	4-2	E. ORGAN 1A	4-2	E. ORGAN 1B
	27	4-3	ROCK ORGAN WITH OLD TONE CAB	4-3	E. ORGAN 2A	4-3	E. ORGAN 2B
	28	4-4	E. PIANO [L]/JAZZ GUITAR [R]	4-4	E. PIANO 4A	4-4	JAZZ GUITR
	29	4-5	ELEC. BASS [L]/E. PIANO [R]	4-5	ELEC. BASS	4-5	E. PIANO 4B
	30	4-6	DOUBLE HARPS	4-6	OBL. HARP A	4-6	OBL. HARP B
	31	4-7	AFRICAN MALLETS	4-7	A. MALLET A	4-7	A. MALLET B
	32	4-8	VIBRAPHONE	4-8	VIBES A	4-8	VIBES B
COMPLEX	33	5-1	ELECTRIC PIANO & BRASS [BC1]	II 1-1	E.P. & BR A	II 1-1	E.P. & BR B
	34	5-2	ELECTRIC GRAND & BRASS [BC1]	1-2	E. GRD & BR A	1-2	E. GRD & BR B
	35	5-3	ELECTRIC PIANO & SAX [BC1]	1-3	E. PIANO 5A	1-3	SAX [BC1]
	36	5-4	ELEC. PIANO & CLAV ENSEMBLE	1-4	E. PIANO 6A	1-4	CLAV. 2B
	37	5-5	ELECTRIC PIANO & STRINGS	1-5	E. PIANO 7A	1-5	STRINGS 1B
	38	5-6	HARPSICHORD & STRING ENSEMBLE	1-6	HARPSI 2A	1-6	STRINGS 2B
	39	5-7	FULL ORCHESTRA	1-7	ORCHESTRA	1-7	ORCH. CHIME
	40	5-8	RIDE CYMBAL & FRETLESS BASS	1-8	FRETLES 1A	1-8	R. CYMBAL
SPLIT	41	6-1	KICK DRUM [L]/SNARE [R]	II 2-1	KICK DRUM	II 2-1	SNARE
	42	6-2	HI-HAT CLOSING [L]/CYMBAL [R]	2-2	CL. HI-HAT	2-2	CYMBAL
	43	6-3	HAND CLAPS [L]/TOM TOMS [R]	2-3	HAND CLAPS	2-3	TOM TOMS
	44	6-4	LOG DRUMS [L]/ROTO TOMS [R]	2-4	LOG DRUMS	2-4	ROTO TOMS
	45	6-5	TAMBOURINE [L]/TIMBALI [R]	2-5	TAMBOURINE	2-5	TIMBALI
	46	6-6	COWBELL [L]/WOOD BLOCK [R]	2-6	COWBELL	2-6	WOOD BLOCK
	47	6-7	FRETLESS BASS [L]/SAX [BC1] [R]	2-7	FRETLES 2A	2-7	SAX [BC1]
	48	6-8	ACOUSTIC PIANO [L]/FLUTE [R]	2-8	PIANO 1A	2-8	FLUTE
SYNTH	49	7-1	SYNTHESIZER UPRISING	II 3-1	SYN-RISE A	II 3-1	SYN-RISE B
	50	7-2	SAMPLE & HOLD [L]/LEAD LINE [R]	3-2	SAMPLE & HLD	3-2	LEAD LINE
	51	7-3	POLY SYNTH [L]/LEAD SYNTH [R]	3-3	POLY SYNTH	3-3	LEAD SYNTH
	52	7-4	PERCUSSIVE SYNTH	3-4	PERC. SYN A	3-4	PERC. SYN B
	53	7-5	TOY MUSIC BOX	3-5	MUSIC BX A	3-5	MUSIC BX B
	54	7-6	FM ENSEMBLE	3-6	FM ENS A	3-6	FM ENS. B
	55	7-7	PLANET OF ICE	3-7	PLAN ICE A	3-7	PLAN ICE B
	56	7-8	MALE & FEMALE CHOIR	3-8	F. CHOIR	3-8	M. CHOIR
EFFECT	57	8-1	"BIG BEN" [L]/TUNED BELLS [R]	II 4-1	BIG BEN	II 4-1	TUNED BELL
	58	8-2	GLASS WIND CHIMES	4-2	GLASS WC A	4-2	GLASS WC B
	59	8-3	JUNGLE NOISE (GROWL/BIRDS)	4-3	GROWL	4-3	BIRDS
	60	8-4	SIDE TO SIDE	4-4	TWO FOUR	4-4	ONE THREE
	61	8-5	TRAFFIC	4-5	TRAFFIC A	4-5	TRAFFIC B
	62	8-6	FLOATING CLOUDS	4-6	FL. CLOUD A	4-6	FL. CLOUD B
	63	8-7	COMBAT (EXPLOSION [L]/GUNS [R])	4-7	EXPLOSION	4-7	MACHINEGUN
	64	8-8	BOMBS AWAY!!	4-8	BOMB DROP A	4-8	BOMB DROP B

New voices created on the DX5 can also be stored in optional RAM voice cartridges. This process will be discussed in CHAPTER VIII: MEMORY MANAGEMENT.

---

---

### **3. Performance Memory Configuration**

The performance memory is one of the special features of the DX5 that sets it apart from other synthesizers. This memory is arranged in 8 banks of 8 performance combinations. Each of these 64 performance combinations can be assigned a single voice number, or a combination of two voice numbers--one from channel A and one from channel B. In addition, each performance memory can be programmed with an independent set of performance parameters (pitch wheel, modulation wheel, foot controller, breath controller, keyboard initial and after touch, portamento, etc) that apply to the corresponding voice or voice combination. Thus, when a performance memory is selected the corresponding voice(s) and performance parameters are simultaneously called, ready for immediate use.

Initially, the DX5 performance memory is factory pre-programmed with 64 performance combinations which can be used immediately. These can later be re-programmed as required. The same data is also supplied on a performance ROM cartridge. New performance combinations that you create can also be stored on optional RAM cartridges.

---

---

### **4. The Voice and Performance Edit Buffers**

The DX5 also has two more special memory locations that we have not seen yet: the voice edit buffer and the performance edit buffer (actually, there are two voice edit buffers, one for channel A and one for channel B; there is only one performance edit buffer). Any time an internal or external cartridge voice is selected, its data is automatically loaded into the voice edit buffer. It is this data in the voice performance buffer which the DX5 actually "plays" when you select a voice. The same applies to the performance edit buffer: when you select a performance memory its data is called into the performance edit buffer where it can be "played". These edit buffers are also where the voice or performance data resides while you edit it to create new voices or performance combinations. After you have edited a voice or performance combination, the new data must be stored in an appropriate internal or external memory location. If this is not done, the data you have spent so much time working on in the corresponding edit buffer will be erased and lost forever the next time you select a new voice or performance memory (see CHAPTER VII: STORING VOICE AND PERFORMANCE DATA).

---

# CHAPTER III: PLAYING THE PRE-PROGRAMMED VOICES

---

---

## 1. Internal/Cartridge Voice Memory Selection

The two violet switches in the rightmost block of switches on the DX5 panel--labelled CARTRIDGE A and CARTRIDGE B--determine whether the internal voice memory or external cartridge voice memory is available for selection using the voice selector switches located in the middle of the panel, below the LCD display. Note that the CARTRIDGE switches are also labelled EDIT A and EDIT B in violet. These labels refer to other functions accessible via these switches, which will be discussed later.

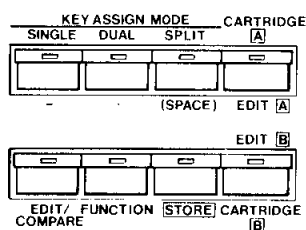

When either of the CARTRIDGE switch LEDs are ON the respective external cartridge voice memories are selected. When OFF, the corresponding internal voice memory channel is selected. These switches make it possible to simultaneously select one internal and one external voice memory if desired. Or, naturally, both internal or external memories can be selected.

### NOTE:

A cartridge memory can only be selected when an appropriate memory cartridge is properly plugged into the selected cartridge slot--A or B. Cartridge slots A and B correspond to voice generator channels A and B.

---

## 2. Key Assign Mode Selection

Now notice that in the same block of switches we have three KEY ASSIGN MODE selections--SINGLE, DUAL and SPLIT. These three keyboard modes function as follows:

**SINGLE** -- In this mode only a single voice may be selected at a time (the two-line LCD display will display only one voice on the top line). The selected voice will be playable over the entire keyboard.

**DUAL** -- In this mode one voice from channel A and one voice from channel B may be selected simultaneously. Both voices will be played over the entire length of the keyboard (i.e. they will sound together).

**SPLIT** -- In this mode the channel A and B voices may be assigned to different areas of the keyboard for split keyboard effects. The channel A voice is assigned to the left side of the keyboard while the channel B voice is assigned to the right side of the keyboard. This means that you can, for example, assign a bass voice to the left side of the keyboard and a piano voice to the right side of the keyboard, and play each part separately with the left and right hands.



In the DUAL key assign mode the channel A voice data will be displayed on the upper line of the LCD display, and the channel B voice data will be shown on the lower line.

In the SPLIT key assign mode the display is basically the same as for the DUAL mode, above, except that the currently selected split point will be displayed following the channel B voice data on the lower line of the display--e.g. "SP=C3".

```
INT. A2-8 STRINGS A POLY SRC=0  
INT. B2-8 TRUMPET A POLY SRC=0
```

# CHAPTER IV: PLAYING THE PERFORMANCE COMBINATIONS

**NOTE:**

Since the factory-programmed performance combinations also use cartridge voices, be sure to plug voice cartridges A and B into the corresponding slots before trying out the performance memories. Since banks I of the voice cartridges contain the same voices as the internal voice memory, switch both cartridges to bank II before inserting.

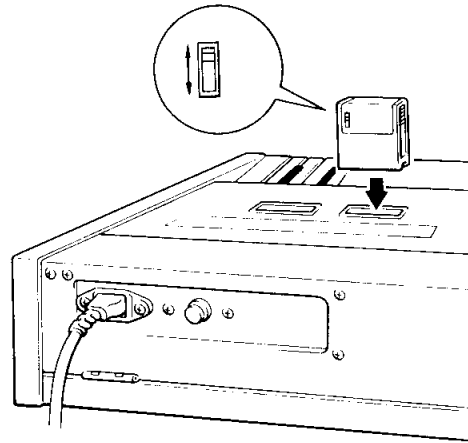

## 1. Performance Memory Selection

The DX5's 64 performance memories are selected using the two rows of light-green switches to the right of the voice selectors. The top row of eight switches selects performance memory BANK 1 through 8, while the lower row of eight switches selects PERFORMANCE & VOICE data 1 through 8 within each BANK.

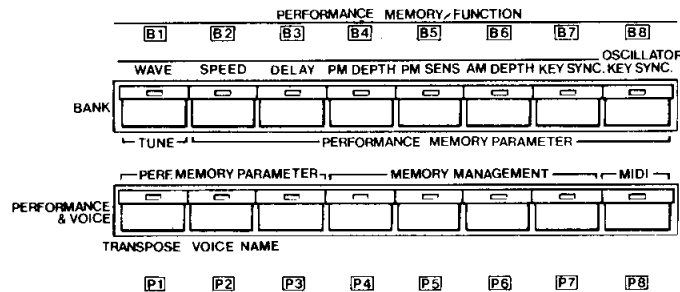

To select the first performance memory in the second bank, for example, press switch B2 in the upper row and then switch P1 in the lower row. If the factory-programmed data is still intact (if not, you can reload the factory data from the provided performance ROM cartridge--see CHAPTER VIII: MEMORY MANAGEMENT, function job P6-J2: LOAD FROM CARTRIDGE) you'll end up with a combination of the CELLOS 1A and CELLOS 2 voices forming a cello quartet voice, complete with appropriate pitch bend, modulation wheel vibrato, touch response, aftertouch vibrato, and other performance parameters. Note that the current key assign mode

is DUAL and that the selected voices are internal. Now, still in BANK 2, press the P3 switch. With the factory performance data this will give you a combination of STRING ENSEMBLE and SOLO VIOLIN voices. Note, however, that the key assign mode has now automatically switched to SPLIT and the split point--shown on the LCD--is set at F3. Now press the BANK 5 (B5) switch so you call the third performance memory in the fifth bank: this will be a combination of ELECTRIC PIANO 5A and BREATH CONTROL SAXOPHONE (the fact that the sax voice requires breath control is indicated by "[BC1]" immediately following the voice name). The key assign mode will revert to DUAL, but the CARTRIDGE A and CARTRIDGE B switches will light, indicating that these voices are being called from the external cartridge voice memories.

Voice numbers, performance parameters, key assign mode and internal/cartridge memory selection can all be programmed as desired to create your own performance combinations. The programming of performance parameters will be discussed in CHAPTER V: FUNCTION PROGRAMMING, while the storing of programmed performance parameters, voice numbers, key assign mode, etc., in the performance memory will be discussed in CHAPTER VII: STORING VOICE AND PERFORMANCE DATA.

---

## 2. Calling the Performance Name

Like the individual voices, each performance combination can be given an identifying name. The performance name can be called by pressing the currently selected BANK switch a second time. Press the same switch again to return to the normal dual voice display.

```
PERFORMANCE MEMORY #2-8  
*** STRINGS & VELOCITY TRUMPETS ***
```

---

## 3. Accessing a Performance Cartridge

Data in a performance memory cartridge--either the supplied ROM performance cartridge or optional user-programmed RAM1 performance cartridges--can be accessed and called into the performance edit buffer for use with the internal voices. This is accomplished by inserting the appropriate performance cartridge into the CARTRIDGE A slot, then pressing the CARTRIDGE A switch while holding down any performance memory selector. Any performance memory now selected will be accessed from the cartridge, rather than the internal performance memory. This can be confirmed by calling the performance name: a <<CARTRIDGE>> identifier will appear beside the performance name.

Performance cartridge access can be turned OFF simply by turning off the CARTRIDGE A switch.

To call the entire performance cartridge contents into the internal performance memory, use the LOAD CARTRIDGE function described in CHAPTER VIII: MEMORY MANAGEMENT.

# CHAPTER V: FUNCTION PROGRAMMING

The "functions" discussed in this section are all programmable parameters which are not directly concerned with voice programming. Although the performance memory parameters do affect the voices--modulation, portamento, etc.--none of them are used to actually change the character of a voice. Voice programming is a separate subject which will be discussed in CHAPTER VI: PROGRAMMING VOICES.

FUNCTION JOB TABLE

BANK	TUNE	PERFORMANCE MEMORY PARAMETER						
	B1	B2	B3	B4	B5	B6	B7	B8
JOB 1	MASTER TUNE	POLY/MONO	PITCH BEND RANGE	PORTAMENTO/GLISSANDO	SUSTAIN PEDAL ASSIGN	OUTPUT LEVEL ATTENUATE	MOD. WHEEL SENSITIVITY	FOOT CONT. SENSITIVITY
JOB 2	DUAL MODE DETUNE	SOURCE SELECT	PITCH BEND STEP	PORTAMENTO MODE	PORTAMENTO PEDAL ASSIGN	PROG. OUT ASSIGN	MOD. WHEEL ASSIGN	FOOT CONT. ASSIGN
JOB 3				PORTAMENTO TIME				

PERF.	PERF. MEMORY PARAMETER			MEMORY MANAGEMENT				MIDI
	P1	P2	P3	P4	P5	P6	P7	P8
JOB 1	BRTH CONT. SENSITIVITY	AFTER TOUCH SENSITIVITY	SPLIT POINT	COPY OP DATA	INITIALIZE MEMORY	SAVE TO CARTRIDGE	PROTECT MEMORY WRITE	MIDI ON/OFF REMOTE SEQ.
JOB 2	BRTH CONT. ASSIGN	AFTER TOUCH ASSIGN	KEY SHIFT	SAVE TEMP. OPERATOR	RECALL EDIT BUFF.	LOAD FROM CARTRIDGE	CLEAR ALL MEMORY	SET STATUS
JOB 3			PERFORMANCE NAME			CHANGE CART. FORMAT	CHECK BATTERY	TRANSMIT DATA

## 1. Function "Job" Organization

The FUNCTION JOB TABLE shown above is the same as the one printed on the DX5 panel. It shows the various "jobs" which can be accessed using the performance memory switches B1 through B8 and P1 through P8. Note that each switch accesses up to three different functions, in addition to their use as performance memory selectors. This design approach has been taken to minimize the number of panel switches required, thereby generally simplifying the panel layout as well as operation. Also note that the job groups are further divided into four groups: TUNE (B1), PERF. MEMORY PARAMETERS (B2 through P3), MEMORY MANAGEMENT (P4 through P7), and MIDI (P8). The TUNE jobs deal with overall DX5 tuning, the PERF. MEMORY PARAMETERS are all functions which can be programmed into the performance memory and deal with performance effects, the MEMORY MANAGEMENT jobs deal with memory-related operations, and the MIDI jobs permit setting MIDI parameters for communication with other MIDI compatible equipment.

In this chapter we will cover only the TUNE and PERF. MEMORY PARAMETER groups (B1 through P3). The MEMORY MANAGEMENT and MIDI function groups will be covered in chapters VIII and IX, respectively.

## 2. The FUNCTION Mode: Accessing the Function Jobs

These functions are accessed by first activating the cream colored FUNCTION switch in the bottom row of the rightmost group of panel switches. When activated, the FUNCTION switch LED will light.

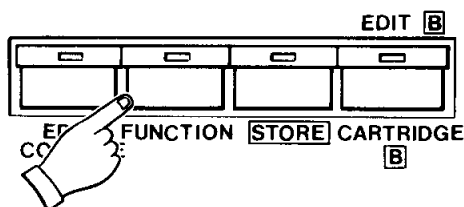



Then, the desired job group is called by pressing the corresponding light-green switch (B1--B8, P1--P8). The first job in the selected job group is initially called, and subsequent presses on the same switch call the following jobs in the group in the order in which they are listed on the table. The first job is returned to following the last job, thus you can cycle through each job group to locate the desired job. The selected job group appears on the top line of the LCD display, the currently selected job being indicated by the flashing block cursor. For function job groups B1 through P3 the currently set values for each job appear immediately below each job descriptor, on the lower line of the display. For example, if you select job group B1 (selecting by pressing FUNCTION and then the B1 switch) the LCD display will look something like this:

```

Func B1 M tune Detune
      + 0      1
  
```

"Func B1" indicates that function job group B1 is selected, "M Tune" is the master tune job, and "Detune" is the detune job. Below each job descriptor there will be a value—in this case "+0" for master tune, and "1" for detune. The flashing cursor is initially over the "M" in "M Tune", indicating that the master tune job is selected. If the B1 switch is pressed a second time the cursor will skip over to the first letter of "Detune" indicating that the detune job is selected. Pressing the B1 switch again will cause the cursor to return to the master tune job. All other job groups are accessed in the same way. In some cases, however, the display will show job descriptors accessed by more than one switch, but only the jobs specified by the selected switch can be accessed. This has been done to allow you to see the values set for other jobs which may interact with the currently selected jobs.

In the MEMORY MANAGEMENT job groups P4 through P7 the bottom LCD line will display prompts allowing you to choose between specified memory operations and select "subjobs". The same subjob format is employed in the MIDI job group--each job may contain several subjobs which are selected using the DATA ENTRY -1 switch.

This FUNCTION mode is exited by pressing the FUNCTION switch again.

### 3. Entering Function Data

Once the desired job has been selected, its value can be altered using either the linear DATA ENTRY control located to the left of the panel, or the adjacent cream colored -1/NO/OFF and +1/YES/ON switches.

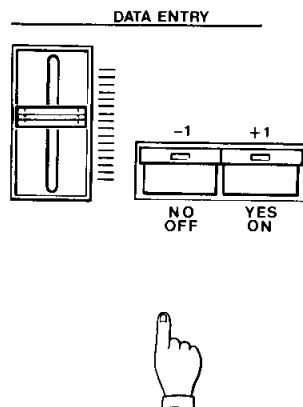

Moving the DATA ENTRY control away from you increases the value of the selected parameter, and moving the control towards you decreases the data value. Pressing the -1 switch decreases the value of the selected parameter by one (decrements), and pressing the +1 switch increases the value by one (increments). While the DATA entry control is valuable for quickly approaching the desired value with

---

---

## 4. The Performance Functions and Their Use

parameters that have a large data range, the +1 and -1 switches permit precise step-wise location of a specific value. The switches are also easier to use with parameters that only have two values--e.g. ON (1) or OFF (0). In some cases you will be required to answer YES or NO to prompts which will appear on the LCD display. The -1/NO/OFF and +1/YES/ON switches are used for this.

In the following we'll take a detailed look at each function contained in the TUNE and PERF. MEMORY PARAMETER groups (B1 through P3), how it is programmed, and what it does. The MEMORY MANAGEMENT and MIDI job groups will be described in chapters VIII and IX, respectively. For simplicity, each job will be specified by its switch and job numbers as follows: B3-J2, for example, specifies the second job (J2) called by the B3 switch--PITCH BEND STEP. If you're not sure how to access and enter data into the various function jobs, go back and read 1, 2 and 3, above.

Please note that when you program any of the PERF. MEMORY PARAMETERS described below, the programmed changes reside in a special performance edit buffer memory which is separate from the 64 selectable performance memories. Data in the performance edit buffer affects the currently selected voices. When a performance memory is selected, for example, the performance data it contains is sent to the performance edit buffer where it affects the corresponding voices. Edited performance memory parameters must therefore be stored in the appropriate performance memory location as they will be erased from the performance edit buffer the next time a performance memory is selected. Storing edited performance parameters is discussed in CHAPTER VII: STORING VOICE AND PERFORMANCE DATA.

### **B1-J1: MASTER TUNE**

Func	B1	M	tune	Detune
			+ 0	1

This is the DX5 MASTER TUNE function. All voices in both channels A and B are affected simultaneously, and MASTER TUNE data cannot be stored in the performance memory.

The programmable data range is from -63 to +63. When set to +0 the pitch of A3 is the standard 440 Hz. At the lowest setting of -64 the overall pitch of the keyboard is 75 cents (3/4 semitone) lower than standard pitch, and at the highest setting of +63 the overall pitch of the keyboard is 75 cents higher than standard pitch.

The MASTER TUNE function does not affect operators which are set to the FIXED FREQUENCY mode (see CHAPTER VI: PROGRAMMING VOICES).

### **B1-J2: DUAL MODE DETUNE**

This function makes it possible to detune the pitches of channels A and B to create chorus-type effects. DUAL MODE DETUNE only functions when the key assign mode is set to DUAL.

The data range is from 0 to 15. At 0 no detune effect is produced. The greatest (deepest) detune effect--a pitch difference between channels A and B of approximately 1/4 semitone--is achieved with a setting of 15. The detune effect is produced by simultaneously increasing the pitch of channel A while decreasing the pitch of channel B.

This function will not affect operators which are set to the FIXED FREQUENCY mode, and can be set independently of the OSCILLATOR DETUNE function (see CHAPTER VI: PROGRAMMING VOICES).

### **B2-J1: POLY/MONO**

Func B2B	Ply/Mon	Source	PB	rng	PB	stp
	Poly	0	5		0	

This function selects either the POLY or MONO note output mode.

There are two possible settings: POLY and MONO. In the POLY mode the note output configuration depends on the KEY ASSIGN MODE setting. When KEY ASSIGN MODE is set to SINGLE up to 32 notes can be played simultaneously. When set to SPLIT up to 16 notes may be simultaneously played on each side of the split point (16 + 16). When set to DUAL up to 16 notes may be played simultaneously. In the MONO mode the DX5 acts as a last-note-priority monophonic keyboard.

This function can be set independently for voice generator channels A and B. The channel in which this function is to be programmed can be selected by pressing any violet BANK or VOICE selector in the corresponding channel. The selected channel will be indicated immediately following the function switch number at the left of the top line of the LCD display--e.g. "Func B2A" or "Func B2B".

The POLY/MONO status of each voice is displayed on the LCD during normal play operations.

### **B2-J2: SOURCE SELECT**

This function selects the control source for the DX5's two voice generators. Normally, this is the DX5 keyboard. In cases where the DX5 voice generators are to be controlled via an external sequencer or music computer, for example, the SOURCE SELECT function must be set to match the device (source) which will transmit the control data to the DX5. The data range is from 0 to 16. A 0 setting selects the DX5 keyboard as the control source, while a setting between 1 and 16 selects the corresponding MIDI channel number. Control data is received via the DX5's MIDI IN terminal, via the selected MIDI channel.

When the DX5 OMNI mode is OFF, the keyboard will not function when SOURCE SELECT is set between 1 and 16 (see CHAPTER IX: MIDI FUNCTIONS, function job P8-J2: SET STATUS).

The SOURCE SELECT status of each channel is displayed on the LCD during the normal play mode (SRC=0).

This function can be set independently for voice generator channels A and B. The channel in which this function is to be programmed can be selected by pressing any violet BANK or VOICE selector in the corresponding channel. The selected channel will be indicated immediately following the function switch number at the left of the top line of the LCD display--e.g. "Func B2A" or "Func B2B".

### **B3-J1: PITCH BEND RANGE**

Func B3B	Ply/Mon	Source	PB	rng	PB	stp
	Poly	0	5		0	

This function sets the pitch range of the pitch bend wheel located to the left of the DX5 keyboard. The pitch bend wheel automatically centers at normal pitch. It then may be moved upward to raise the pitch, or moved downward (toward the player) to lower the pitch by the specified amount.

The data range is from 0 to 12. At 0 the pitch bend wheel is off. Each increment between 1 and 12 represents a semitone. Thus if this function is set to 12, maximum travel of the pitch bend wheel produces a one-octave pitch variation, both above and below center position--i.e. plus or minus one octave.

PITCH BEND RANGE will have no effect if PITCH BEND STEP, described below, is set to a value between 1 and 12.

This function can be set independently for voice generator channels A and B. The channel in which this function is to be programmed can be selected by pressing any violet BANK or VOICE selector in the corresponding channel. The selected channel will be indicated immediately following the function switch number at the left of the top line of the LCD display--e.g. "Func B3A" or "Func B3B".

### **B3-J2: PITCH BEND STEP**

This function creates a stepped pitch bend effect, rather than the continuous pitch bend produced by PITCH BEND RANGE, above.

The data range is from 0 to 12. At 0 the normal pitch bend function may be used. When set between 1 and 12, however, the stepped pitch bend effect is activated and the range is fixed at plus or minus one octave. At 1 a series of 12 semitone steps are produced when the pitch bend wheel is rotated (plus or minus 12 steps). Each increment increases the size of the steps by 100 cents (one semitone), while simultaneously decreasing the number of steps produced. When set at 12 a single one octave step (plus or minus) is produced.

This function can be set independently for voice generator channels A and B. The channel in which this function is to be programmed can be selected by pressing any violet BANK or VOICE selector in the corresponding channel. The selected channel will be indicated immediately following the function switch number at the left of the top line of the LCD display--e.g. "Func B3A" or "Func B3B".

### **B4-J1: PORTAMENTO/GLISSANDO**

Func B4B	PG sw	P mode	P time
	Port	Retain	0

This function selects between a smooth, continuous portamento slide effect or a stepped (semitone steps) glissando slide effect.

Two settings are possible: PORT or GLIS. Both portamento and glissando time are determined either by the linear PORTAMENTO control to the left of the DX5 panel or the PORTAMENTO TIME job described below. Both the PORTAMENTO control and the PORTAMENTO TIME function can be used to turn the portamento or glissando effect OFF or ON.

This function can be set independently for voice generator channels A and B. The channel in which this function is to be programmed can be selected by pressing any violet BANK or VOICE selector in the corresponding channel. The selected channel will be indicated immediately following the function switch number at the left of the top line of the LCD display--e.g. "Func B4A" or "Func B4B".

### **B4-J2: PORTAMENTO MODE**

In all, four different portamento modes are available--two in the POLY mode and two in the MONO mode (see POLY/MONO select job B2-J1).

In the POLY mode the selectable portamento modes are RETAIN and FOLLOW. In the MONO mode the selectable portamento modes are FINGERED and FULL TIME. These modes function as follows:

- (a) RETAIN (POLY mode): This mode permits sustained notes to be held (retained) while a subsequent note is played with the portamento effect.
- (b) FOLLOW (POLY mode): In this mode all notes played immediately portamento to a subsequently played note.
- (c) FINGERED (MONO mode): Portamento only occurs if the previously played note is held while the next note is played. This mode is useful in recreating the effect of guitar string bending techniques, wood bass slide effects, etc.
- (d) FULL TIME (MONO mode): A conventional monophonic portamento effect in which portamento occurs whenever a new note is played.

This function can be set independently for voice generator channels A and B. The

channel in which this function is to be programmed can be selected by pressing any violet BANK or VOICE selector in the corresponding channel. The selected channel will be indicated immediately following the function switch number at the left of the top line of the LCD display--e.g. "Func B4A" or "Func B4B".

**B4-J3: PORTAMENTO TIME**

This function sets the speed of the portamento or glissando effect. This can also be accomplished using the linear PORTAMENTO control on the DX5 panel.

The data range is from 0 to 99. At 0 portamento is off. A setting of 99 produces the longest portamento or glissando slide.

When PORTAMENTO PEDAL ASSIGN (B5-J2, below) is ON, the PORTAMENTO control can be used to enter data for this function, as well as the DATA ENTRY section.

This function can be set independently for voice generator channels A and B. The channel in which this function is to be programmed can be selected by pressing any violet BANK or VOICE selector in the corresponding channel. The selected channel will be indicated immediately following the function switch number at the left of the top line of the LCD display--e.g. "Func B4A" or "Func B4B".

**B5-J1: SUSTAIN PEDAL ASSIGN**

Func B5B	Sus	Pd1	Por	P&K	Att	P out
	On		On		7	On

This function turns the sustain footswitch (Yamaha FC4 or FC5, optional) connected to the rear-panel SUSTAIN jack ON or OFF. When ON the sustain pedal can be used to control the sustain effect. When OFF the sustain pedal will not function.

This function can be set independently for voice generator channels A and B. The channel in which this function is to be programmed can be selected by pressing any violet BANK or VOICE selector in the corresponding channel. The selected channel will be indicated immediately following the function switch number at the left of the top line of the LCD display--e.g. "Func B5A" or "Func B5B".

**B5-J2: PORTAMENTO PEDAL ASSIGN**

This function turns the PORTAMENTO control and rear-panel PORTAMENTO footswitch jack (accepts Yamaha FC-4 or FC-5 foot switches) ON or OFF. When OFF neither the PORTAMENTO control or footswitch will function. When ON the PORTAMENTO control can be used to directly set portamento or glissando time, while the footswitch connected to the PORTAMENTO jack can be used to turn the portamento or glissando effects ON or OFF.

This function can be set independently for voice generator channels A and B. The channel in which this function is to be programmed can be selected by pressing any violet BANK or VOICE selector in the corresponding channel. The selected channel will be indicated immediately following the function switch number at the left of the top line of the LCD display--e.g. "Func B5A" or "Func B5B".

**B6-J1: OUTPUT LEVEL ATTENUATE**

Func B6B	Sus	Pd1	Por	P&K	Att	P out
	On		On		7	On

This function adjusts the level at which the corresponding voice will be output from the DX5's audio output jacks. This is particularly useful in compensating for the level variations that frequently occur between voices.

The data range is from 0 to 7. A 0 setting turns output off (0%), and a setting of 7 delivers maximum output level (100%). Other settings produce the following percentages of maximum output: 1=2%, 2=4%, 3=8%, 4=15%, 5=30%, 6=54%.

This function can be set independently for voice generator channels A and B. The channel in which this function is to be programmed can be selected by pressing any violet BANK or VOICE selector in the corresponding channel. The selected channel will be indicated immediately following the function switch number at the left of the top line of the LCD display--e.g. "Func B6A" or "Func B6B".

**B6-J2: PROGRAM OUTPUT ASSIGN**

This function turns the DX5's P (PROGRAM) audio outputs--both phone jack and XLR jack--ON or OFF. The output at the PROGRAM jacks is a mono mix of both channels A and B only when this function is ON for both channels. The A and B outputs are ON at all times.

This function can be set independently for voice generator channels A and B. The channel in which this function is to be programmed can be selected by pressing any violet BANK or VOICE selector in the corresponding channel. The selected channel will be indicated immediately following the function switch number at the left of the top line of the LCD display--e.g. "Func B6A" or "Func B6B".

**B7-J1: MODULATION WHEEL SENSITIVITY**

Func B7B	Mod	EAP	Ft.	EAP	Br.	EAP	Aft	EAP
3	111	0	000	0	000	13	001	

The modulation wheel can be used to control the depth of tremolo, wow, brilliance, expression (volume) or vibrato type effects, according to the MODULATION WHEEL ASSIGN setting described below. This function sets the maximum depth of the assigned effect (maximum depth is achieved with the modulation wheel rotated fully away from the performer).

The data range is from 0 to 15. At 0 the modulation wheel is OFF, and at 15 maximum effect variation can be achieved.

This function will operate only if the AMPLITUDE MODULATION SENSITIVITY and PITCH MODULATION SENSITIVITY voice parameters are set to appropriate values (see CHAPTER VI: PROGRAMMING VOICES).

This function can be set independently for voice generator channels A and B. The channel in which this function is to be programmed can be selected by pressing any violet BANK or VOICE selector in the corresponding channel. The selected channel will be indicated immediately following the function switch number at the left of the top line of the LCD display--e.g. "Func B7A" or "Func B7B".

**B7-J2: MODULATION WHEEL ASSIGN**

This function determines which type of effect will be produced by the modulation wheel. Three options are available: EBC (EG Bias Control), AMD (Amplitude Modulation Depth), or PMD (Pitch Modulation Depth). When assigned to EBC the result is either brilliance or expression (volume) control, depending on the corresponding voice parameter settings. When assigned to AMD the result is either tremolo or wow control, depending on the corresponding voice parameter settings. And when assigned to PMD the result is vibrato control, dependent on the corresponding voice parameter settings (see CHAPTER VI: PROGRAMMING VOICES). Any of these assignments can be used independently or combined.

Data is entered in the form of a three-digit binary number-- "000". The first (leftmost) digit corresponds to EBC, the second (center) digit to AMD, and the third (rightmost) digit to PMD. Each digit can be either a "0" (OFF) or a "1" (ON). Consecutive presses on the +1/YES/OFF switch, or raising the DATA ENTRY control, results in the following sequence of settings:

000 → 001 → 010 → 011 → 100 → 101 → 110 → 111.

Pressing the -1/NO/OFF switch or lowering the DATA ENTRY control reverses this sequence. "001", for example, assigns PMD only. "101" assigns EBC and PMD.

This function can be set independently for voice generator channels A and B. The channel in which this function is to be programmed can be selected by pressing any violet BANK or VOICE selector in the corresponding channel. The selected channel will be indicated immediately following the function switch number at the left of the top line of the LCD display--e.g. "Func B7A" or "Func B7B".

#### **B8-J1: FOOT CONTROLLER SENSITIVITY**

The foot controller (Yamaha FC7 , optional) can be used to control the depth of tremolo, wow, brilliance, expression (volume) or vibrato type effects, according to the FOOT CONTROLLER ASSIGN setting described below. This function sets the maximum depth of the assigned effect (maximum depth is achieved with the foot controller fully depressed).

The data range is from 0 to 15. At 0 the foot controller is OFF, and at 15 maximum effect variation can be achieved.

This function will operate only if the AMPLITUDE MODULATION SENSITIVITY and PITCH MODULATION SENSITIVITY voice parameters are set to appropriate values (see CHAPTER VI: PROGRAMMING VOICES).

This function can be set independently for voice generator channels A and B. The channel in which this function is to be programmed can be selected by pressing any violet BANK or VOICE selector in the corresponding channel. The selected channel will be indicated immediately following the function switch number at the left of the top line of the LCD display--e.g. "Func B8A" or "Func B8B".

#### **B8-J2: FOOT CONTROLLER ASSIGN**

This function determines which type of effect will be produced by the foot controller. Three options are available: EBC (EG Bias Control), AMD (Amplitude Modulation Depth), or PMD (Pitch Modulation Depth). When assigned to EBC the result is either brilliance or expression (volume) control, depending on the corresponding voice parameter settings. When assigned to AMD the result is either tremolo or wow control, depending on the corresponding voice parameter settings. And when assigned to PMD the result is vibrato control, dependent on the corresponding voice parameter settings (see CHAPTER VI: PROGRAMMING VOICES). Any of these assignments can be used independently or combined.

Data is entered in the form of a three-digit binary number-- "000". The first (leftmost) digit corresponds to EBC, the second (center) digit to AMD, and the third (rightmost) digit to PMD. Each digit can be either a "0" (OFF) or a "1" (ON). Consecutive presses on the +1/YES/OFF switch, or raising the DATA ENTRY control, results in the following sequence of settings:

000 → 001 → 010 → 011 → 100 → 101 → 110 → 111.

Pressing the -1/NO/OFF switch or lowering the DATA ENTRY control reverses this sequence. "001", for example, assigns PMD only. "101" assigns EBC and PMD. This function can be set independently for voice generator channels A and B. The channel in which this function is to be programmed can be selected by pressing any violet BANK or VOICE selector in the corresponding channel. The selected channel will be indicated immediately following the function switch number at the left of the top line of the LCD display--e.g. "Func B8A" or "Func B8B".

#### **P1-J1: BREATH CONTROLLER SENSITIVITY**

The Yamaha BC1 breath controller (optional) can be used to control the depth of tremolo, wow, brilliance, expression (volume) or vibrato type effects, according to the BREATH CONTROLLER ASSIGN setting described below. This function sets the maximum depth of the assigned effect (maximum depth is achieved with maximum breath pressure applied to the breath controller mouthpiece).

The data range is from 0 to 15. At 0 the breath controller is OFF, and at 15 maximum effect variation can be achieved.

This function will operate only if the AMPLITUDE MODULATION SENSITIVITY and PITCH MODULATION SENSITIVITY voice parameters are set to appropriate values (see CHAPTER VI: PROGRAMMING VOICES).

This function can be set independently for voice generator channels A and B. The channel in which this function is to be programmed can be selected by pressing any violet BANK or VOICE selector in the corresponding channel. The selected channel will be indicated immediately following the function switch number at the left of the top line of the LCD display--e.g. "Func P1A" or "Func P1B".

### **P1-J2: BREATH CONTROLLER ASSIGN**

This function determines which type of effect will be produced by the breath controller. Three options are available: EBC (EG Bias Control), AMD (Amplitude Modulation Depth), or PMD (Pitch Modulation Depth). When assigned to EBC the result is either brilliance or expression (volume) control, depending on the corresponding voice parameter settings. When assigned to AMD the result is either tremolo or wow control, depending on the corresponding voice parameter settings. And when assigned to PMD the result is vibrato control, dependent on the corresponding voice parameter settings (see CHAPTER VI: PROGRAMMING VOICES). Any of these assignments can be used independently or combined.

Data is entered in the form of a three-digit binary number-- "000". The first (leftmost) digit corresponds to EBC, the second (center) digit to AMD, and the third (rightmost) digit to PMD. Each digit can be either a "0" (OFF) or a "1" (ON). Consecutive presses on the +1/YES/OFF switch, or raising the DATA ENTRY control, results in the following sequence of settings:

000 → 001 → 010 → 011 → 100 → 101 → 110 → 111.

Pressing the -1/NO/OFF switch or lowering the DATA ENTRY control reverses this sequence. "001", for example, assigns PMD only. "101" assigns EBC and PMD.

This function can be set independently for voice generator channels A and B. The channel in which this function is to be programmed can be selected by pressing any violet BANK or VOICE selector in the corresponding channel. The selected channel will be indicated immediately following the function switch number at the left of the top line of the LCD display--e.g. "Func P1A" or "Func P1B".

### **P2-J1: AFTER TOUCH SENSITIVITY**

Keyboard after touch sensitivity can be used to control the depth of tremolo, wow, brilliance, expression (volume) or vibrato type effects, according to the AFTER TOUCH ASSIGN setting described below. This function sets the maximum depth of the assigned effect (maximum depth is achieved with maximum pressure applied to the keyboard).

The data range is from 0 to 15. At 0 after touch sensitivity is OFF, and at 15 maximum effect variation can be achieved.

This function will operate only if the AMPLITUDE MODULATION SENSITIVITY and PITCH MODULATION SENSITIVITY voice parameters are set to appropriate values (see CHAPTER VI: PROGRAMMING VOICES).

This function can be set independently for voice generator channels A and B. The channel in which this function is to be programmed can be selected by pressing any violet BANK or VOICE selector in the corresponding channel. The selected channel will be indicated immediately following the function switch number at the left of the top line of the LCD display--e.g. "Func P2A" or "Func P2B".

### **P2-J2: AFTER TOUCH ASSIGN**

This function determines which type of effect will be produced by keyboard after touch sensitivity. Three options are available: EBC (EG Bias Control), AMD (Amplitude Modulation Depth), or PMD (Pitch Modulation Depth). When assigned to EBC the result is either brilliance or expression (volume) control, depending



on the corresponding voice parameter settings. When assigned to AMD the result is either tremolo or wow control, depending on the corresponding voice parameter settings. And when assigned to PMD the result is vibrato control, dependent on the corresponding voice parameter settings (see CHAPTER VI: PROGRAMMING VOICES). Any of these assignments can be used independently or combined.

Data is entered in the form of a three-digit binary number-- "000". The first (leftmost) digit corresponds to EBC, the second (center) digit to AMD, and the third (rightmost) digit to PMD. Each digit can be either a "0" (OFF) or a "1" (ON). Consecutive presses on the +1/YES/OFF switch, or raising the DATA ENTRY control, results in the following sequence of settings:

000 → 001 → 010 → 011 → 100 → 101 → 110 → 111.

Pressing the -1/NO/OFF switch or lowering the DATA ENTRY control reverses this sequence. "001", for example, assigns PMD only. "101" assigns EBC and PMD. This function can be set independently for voice generator channels A and B. The channel in which this function is to be programmed can be selected by pressing any violet BANK or VOICE selector in the corresponding channel. The selected channel will be indicated immediately following the function switch number at the left of the top line of the LCD display--e.g. "Func P2A" or "Func P2B".

### **P3-J1: SPLIT POINT**

Func P3	Split	Key sft	P name
C3		+0	DOUBLE HORN SEC

This function is used to set the keyboard split point which will be operative when the SPLIT key assign mode is selected. The channel A voice generator will be assigned to all keys to the left of the split point, and the channel B voice generator will be assigned to the right of the split point, including the specified split point key.

The split point can be entered by pressing the appropriate key on the keyboard. The selected key will be displayed on the LCD panel. The data range with this method of data entry is from E0 to E6, however, the split point can only be entered once after this function is called. Further alteration of the split point can be accomplished using the DATA ENTRY control and switches. The data range when using the DATA ENTRY controls is from A-1 to A7--this range, of course, includes keys which are not available on the DX5 keyboard.

The split point key designations which appear on the LCD display are based on standard keyboard pitch, and may not correspond to actual pitch if the KEY SHIFT function (described below) or KEY TRANSPOSE (described in the following section) have been used to alter the overall pitch of the keyboard.

### **P3-J2: KEY SHIFT**

This function can be used to transpose the pitch of the entire keyboard up or down by a maximum of two octaves.

The data range is from -24 to +24, with +00 corresponding to standard keyboard pitch. Each increment corresponds to a shift in pitch of one semitone--a setting of +02 would therefore raise the pitch of the entire keyboard a whole tone.

Data can be entered simply by pressing a key on the keyboard within a plus/minus two octave range of C3 (middle C). The pressed key then assumes the pitch of C3 and all other keys are adjusted accordingly. Pressing a key higher than C5 results in a +24 setting, and pressing a key lower than C1 results in a -24 setting. This method of data entry, however, can only be used once after this function is called. Subsequent changes can be made using the DATA ENTRY control and switches. This function can be set independently for voice generator channels A and B. The channel in which this function is to be programmed can be selected by pressing any violet BANK or VOICE selector in the corresponding channel. The selected

channel will be indicated immediately following the function switch number at the left of the top line of the LCD display--e.g. "Func P3A" or "Func P3B".

### **P3-J3: PERFORMANCE NAME**

This function can be used to give each performance memory location an identifying name. Performance names can be up to 30 characters in length. (This is the same performance name as that discussed in "2. Calling the Performance Name" in the "PLAYING THE PERFORMANCE COMBINATIONS" section.)

When this function is called the flashing cursor will appear at the beginning of the lower display line, ready for you to enter the first character. The characters are entered using the cream colored OPERATOR SELECT and OPERATOR ON/OFF switches to the left of the panel and the violet VOICE BANK and VOICE switches. The dash (-), period (.) and space are entered using the brown KEY ASSIGN MODE switches. Note that all these switches have their corresponding characters or numbers printed in white either above or below them. As each character is entered the flashing cursor moves one space to the right, ready for the next character. A character entered over an existing character will replace the original character. To correct errors, the cursor may be moved to the left and right using the -1/NO/OFF and +1/YES/ON switches, respectively.

#### **REMEMBER**

Once you've programmed any of the above performance memory parameters and intend to keep them, the data must be stored into an appropriate performance memory location. See CHAPTER VII: STORING VOICE AND PERFORMANCE DATA.

# CHAPTER VI: PROGRAMMING VOICES

## 1. The Basics of FM Synthesis

Before you begin actually programming or editing your own voices, a basic understanding of how digital FM synthesis works will be necessary. In the following explanation we will discover how the DX5's FM voice generators produce complex voices. This information will help you to understand the process and make it easier for you to create and edit your own voices.

### OPERATORS

The Yamaha DX series FM digital synthesizers use pure sine waves that interact to create the full harmonic spectrum for any voice. Each digital sine wave oscillator is combined with its own envelope generator to form an "operator".

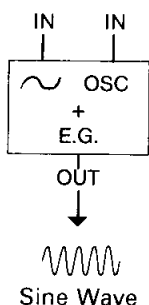

The primary functional circuit in the DX5 is comprised of the digital SINE WAVE OSCILLATOR plus a digital ENVELOPE GENERATOR with multiple inputs and just one output. This is called an OPERATOR.

Note that the operator's oscillator has two inputs: one for the oscillator pitch data, and one for modulation data.

### CARRIERS AND MODULATORS

Each voice generator channel of the DX5 has 6 operators. When the output of one operator is fed to the modulation input of a second operator--i.e. the first operator modulates the second--a whole spectrum of harmonics are created that can form an incredibly diverse range of complex waveforms (including the more conventional triangle, sawtooth, and square waveforms). All this from just two operators!

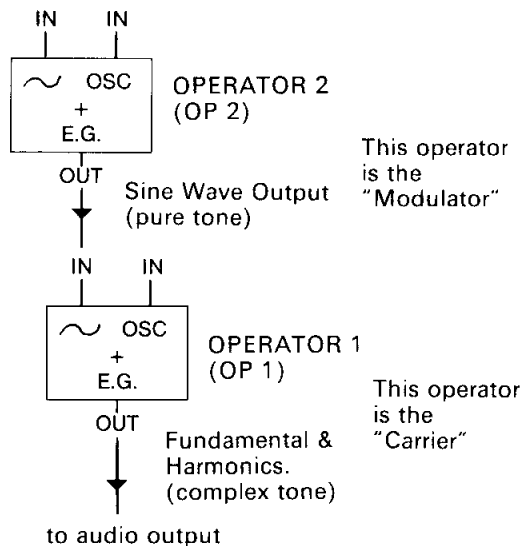

When the output of one OPERATOR is "patched" to the input of another Operator, the result is a complex waveform. This is the essence of FM SYNTHESIS.

Operators do not have to be connected "vertically" in a modulator-carrier relationship, as shown above. The outputs of two operators can also be mixed--just as the stops in an organ are mixed. In this case the sounds are simply added together with no modulation effect.

### ALGORITHMS

We have seen two different ways that two operators may be combined. Each voice generator channel in the DX5 has six operators, offering a lot of potential connection possibilities. These different configurations of operator relationships are called "algorithms", and each channel of the DX5 offers 32 algorithm choices. These are all printed right on the DX5 panel. In the algorithm diagrams on the DX5 panel the small boxes numbered 1 through 6 are the operators.

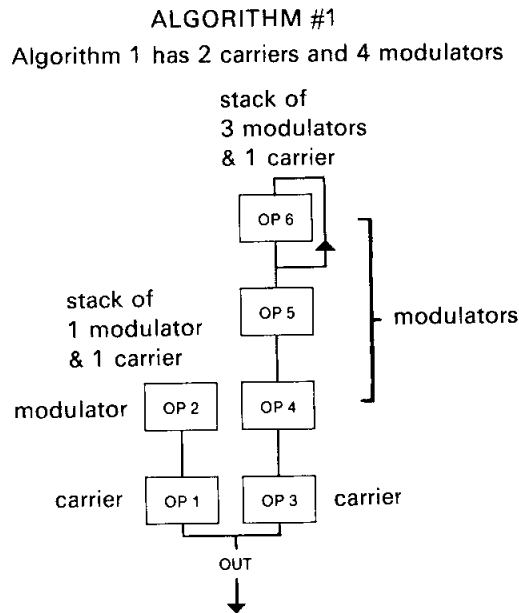

A given arrangement of OPERATORS is called an ALGORITHM. The available Algorithms are numbered. Illustrated here is Algorithm #1, which happens to have 2 parallel STACKS, one with 2 operators, and the other with 4 operators.

## HOW ALGORITHMS AFFECT THE SOUND

By changing the relative frequencies between operators in a modulator-carrier relationship, you change not only the fundamental pitch of the note, but also the frequencies present in the harmonic structure. Thus, the timbre of the voice can be precisely controlled. In addition, since each operator has its own envelope generator (and a sophisticated one, too!), the harmonic structure of a note can be programmed to vary over time, just as a plucked string changes its overtones as the note decays.

Depending on the selected algorithm, operators can be stacked vertically, connected horizontally, or both. In the vertical arrangement, when the output of one operator is connected to the input of another the result is modulation. By convention, the operator at the bottom--or "output"--of a stack of operators is known as a "carrier". All operators in the same stack above the carrier are "modulators". By increasing the output level of one or more modulators feeding a carrier, the number of harmonics in the resultant sound is increased (its "bandwidth" is increased), making it more brilliant.

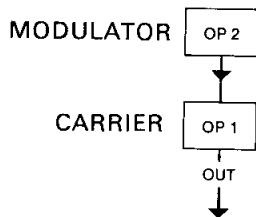

The bottom operator of a stack is called a CARRIER. Any operators which are connected to the carrier's inputs are called MODULATORS. YOU CAN'T HEAR A MODULATOR DIRECTLY, but you hear its effect by listening to the carrier's altered (modulated) output. A given operator can be either a carrier or a modulator: the only difference is how it is "connected" in a given algorithm.

Most algorithms have multiple modulators and carriers. In one algorithm a given operator may be a carrier, while in the next it might function as a modulator--the only difference being how it is connected. In algorithm number 5, for example, there are three vertical stacks of two operators, and the outputs of the carriers in these stacks are connected in parallel (horizontally). Algorithm 5 has an equal number of modulators and carriers--three modulators and three carriers.

### ALGORITHM #5

Algorithm #5 has 3 carriers and 3 modulators

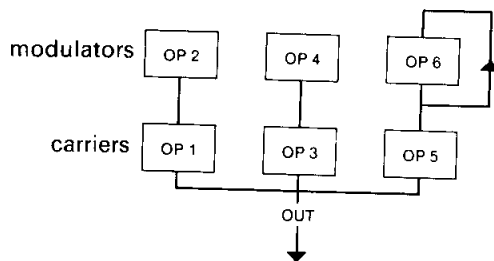

On the other hand, all operators in algorithm 32 function as carriers. Note that no modulation can occur in this algorithm. But algorithm 32 is ideal for creating rich organ voices--think of each operator as different organ "stops", which can be mixed together as desired.

The algorithm alone, however, does not determine the actual sound of the voice. The vital characteristics of the voice you create depend mostly on the frequencies and levels you program into each operator. The 32 algorithms provided in the DX5 were specially selected because they offer the broadest range of voice programming possibilities.

The results of using different frequency ratios, as well as different algorithms, are shown graphically in the accompanying illustration. In the left column you see the waveforms created by 1:1, 2:1 and 3:1 ratios between one modulator and one carrier. In the right column you see the waveforms which result from the same three ratios, but when the two operators used are both carriers (connected horizontally, this is known as additive synthesis).

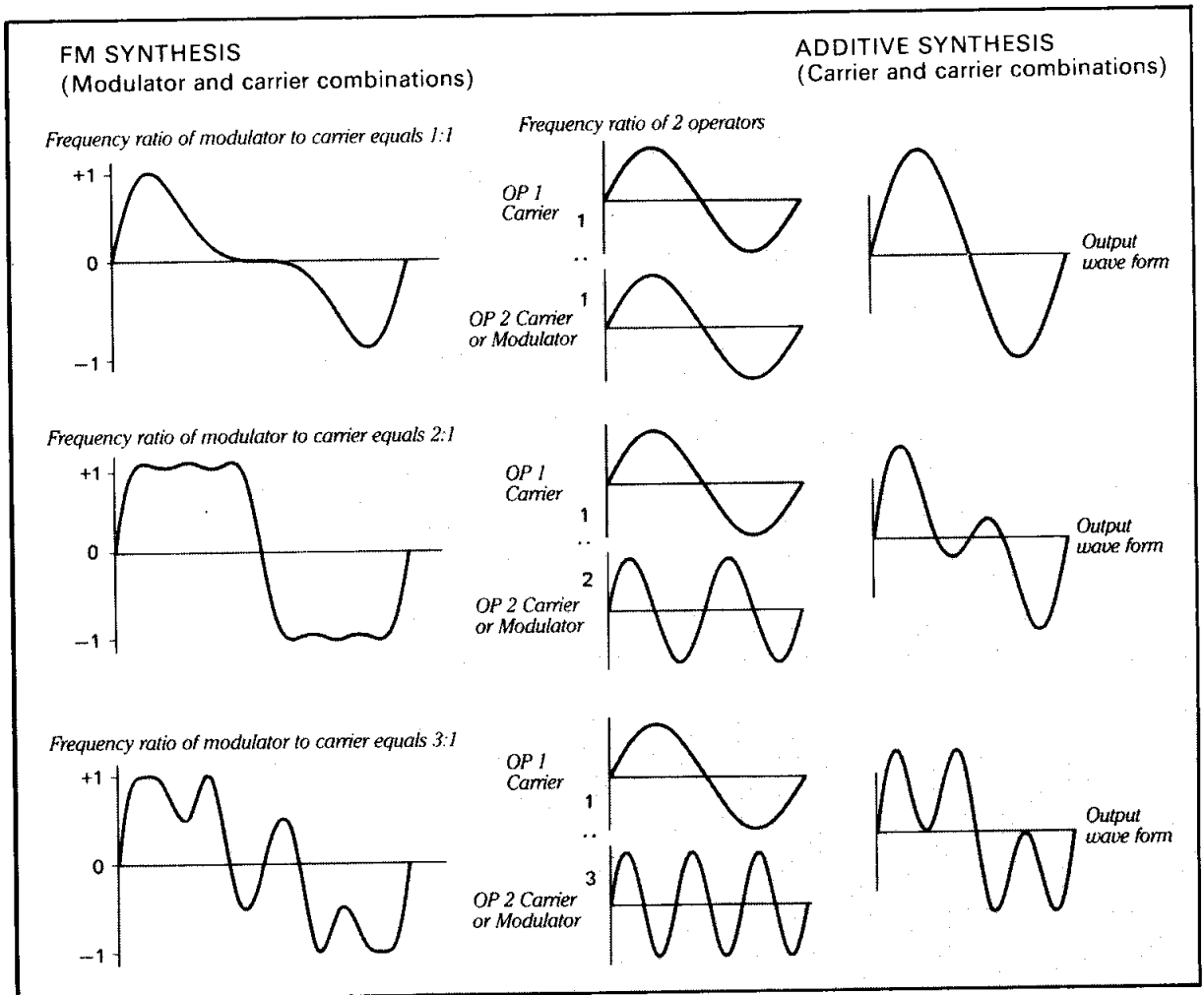

Still more variations can be achieved by changing the relative output levels between operators; the greater the level of the modulating operator, the more harmonics are present.

### FEEDBACK

Note that every algorithm has one operator with a "feedback loop"--represented by a line from the output of the operator which feeds back to the input of the same operator. Algorithms 4 and 6 are exceptions, in which the feedback loop encompasses 3 and 2 operators, respectively. In effect, a feedback loop means that the operator is modulating itself. While every algorithm has one feedback loop, feedback is not necessarily used in every voice. One of the DX5 editing functions permits the feedback level to be set between 0 (no feedback) and 7 (maximum feedback).

In some cases the only difference between algorithms is the position of the feedback loop. This is true with algorithms 3 and 4, and with 5 and 6. If you were to switch back and forth between either pair of algorithms if the feedback loops were OFF (set to 0), you would hear absolutely no difference in the sound. If completely different feedback levels were set, however, the sound would be significantly different.

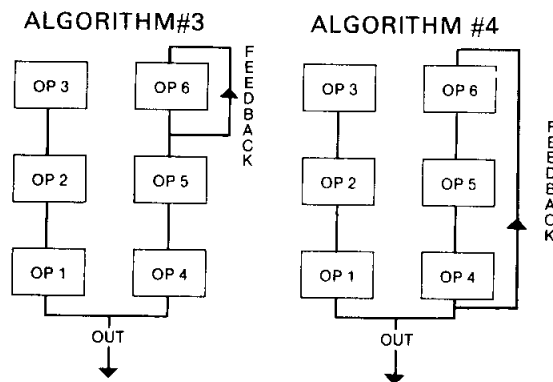

If FEEDBACK is at 0, these two algorithms become identical

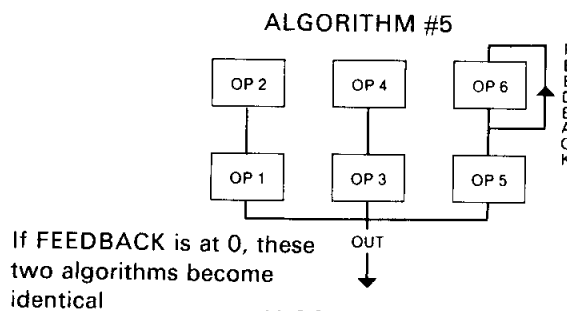

If FEEDBACK is at 0, these two algorithms become identical

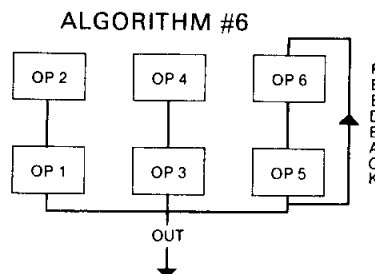

### ENVELOPE GENERATORS

Consider what happens when you play a note on, say, an acoustic instrument. The level of the sound initially goes up to some value, then eventually falls to nothing, following some sort of pattern that is characteristic of the particular instrument played. For example, a low note on a pipe organ starts slowly when you press a key, because it takes a while for the large column of air within the pipe to build up to maximum oscillation level, and takes a while to die down once the key is released. A note played on a wood block, on the other hand, starts quickly as the mallet strikes the block, and stops quickly as the block stops resonating. The characteristic volume pattern of any note played on any instrument is known as its "volume envelope". Most acoustic instruments also have a "timbre envelope", in which the harmonic content of the note changes (the timbre changes) from the time the note is initiated to the time it decays.

Each of the 6 operators available in each channel of the DX5 can be programmed with its own envelope. The envelope applied to a carrier will, generally, contribute to the overall volume envelope of the note, while an envelope applied to a modulator will contribute to the timbre envelope of the note. Here is a copy of the envelope diagram printed above the LCD on the DX5 panel.

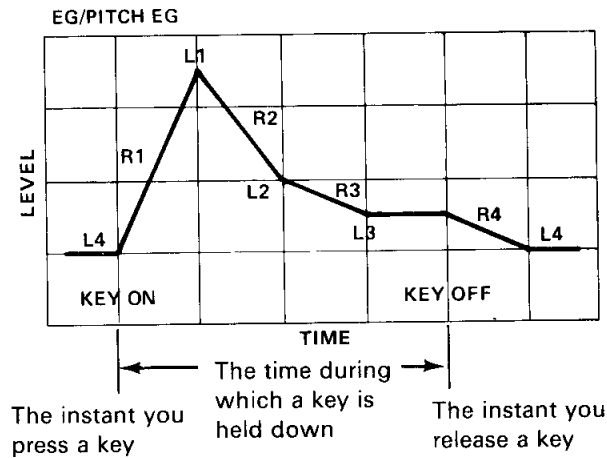

This envelope diagram can be used as a guide in visualizing DX5 envelope settings while you program or edit a voice. There are actually trillions of possible envelopes you can define with these sophisticated envelope generators.

Each envelope generator can be programmed with four different LEVELS, and four different RATES at which the envelope moves from one LEVEL to the next. The term LEVEL is used rather than "volume" because the envelope of the operator you're working on could affect volume or timbre, depending on whether it is a carrier or a modulator.

LEVEL 1 (L1) is the first level the envelope approaches when you press a key. The envelope may reach LEVEL 1 instantly, or it may take over 30 seconds depending on the setting of RATE 1 (R1).

When the envelope reaches LEVEL 1 it immediately begins moving towards the next level in the envelope--LEVEL 2--at a speed determined by the setting of RATE 2.

The change from LEVEL 1 to LEVEL 2 can be either an increase or decrease in level, depending on the values you choose for these points on the envelope curve. If, for example, you set LEVEL 1 at the midpoint, and LEVEL 2 at maximum, when you play a note the level of the operator will increase to LEVEL 1, and then continue to increase to LEVEL 2. If RATE 1 and RATE 2 are the same in this case, you'll hear one smooth, continuous increase in level from note initiation to LEVEL 2. If, however, RATE 1 is slow and RATE 2 is very fast, you'll hear a distinct "knee" in the initial attack slope as the sound slowly reaches LEVEL 1 and then jumps quickly to LEVEL 2.

After reaching LEVEL 2, the envelope then begins to move towards LEVEL 3--which can be higher or lower than LEVEL 2--at a speed determined by the RATE 3 setting. Now, unlike LEVEL 1 and LEVEL 2, the envelope will STAY at LEVEL 3 as long as the key is held (or the sustain pedal is pressed)--LEVEL 3 is basically the "sustain" level. When you release the key (or the sustain pedal) the envelope will begin moving towards LEVEL 4 at RATE 4. In fact, at whatever point in the envelope you release the key the envelope will immediately begin moving toward LEVEL 4 at RATE 4. Typically, LEVEL 4 will be set to 0 (OFF) so that the note eventually stops once LEVEL 4 is reached. RATE 4 is, therefore, analogous to the release time parameter in a standard "ADSR" type envelope generator.



### **THE PITCH EG**

In addition to the EG functions just described, each DX5 voice also has a "PITCH EG". This pitch envelope generator is programmed in exactly the same way as the individual operator EGs, but it affects the overall pitch of the voice rather than level and timbre. This is useful for creating certain types of voices--whistling, for example, in which the pitch of the note usually starts out a bit low and then sweeps up to the proper pitch.

---

## **2. The EDIT and COMPARE modes**

To actually program or edit a voice you need to enter the EDIT mode. This is done by pressing the cream colored EDIT/COMPARE switch in the lower row of the rightmost group of switches on the DX5 panel. When the EDIT mode is activated the EDIT/COMPARE switch LED will light and a group of voice parameters will be displayed on the LCD panel. The last voice selected in the PLAY mode will be selected for editing. The BANK and VOICE selector LEDs of the voice selected for editing will flash. You can switch back and forth between the selected channel A and channel B voices simply by pressing the corresponding violet EDIT A or EDIT B switch.

The individual voice parameters are then selected by pressing the corresponding panel switches--these are the switches with violet labels--and programmed using the DATA ENTRY control and/or switches. The individual parameters will be described in detail below.

In many cases you will be editing an existing voice and will want to compare the sound of the edited voice with the original voice. This is done simply by pressing the EDIT/COMPARE switch again. The EDIT/COMPARE switch LED will now flash, indicating that the DX5 is now in the COMPARE mode, and that the voice you will now hear is the original voice before editing (the parameters displayed on the LCD will also revert to those of the original voice). You can then return to the voice being edited by pressing the EDIT/COMPARE switch again (the LED will remain lit). This can be repeated as many times as needed during the editing process. The COMPARE mode can only be entered from the EDIT mode, however, after at least one data change has been made to the original voice. If you press the EDIT/COMPARE switch while in the EDIT mode prior to making any data changes, the EDIT mode will simply be exited.

The EDIT/COMPARE mode can be exited by pressing any voice selector from the COMPARE mode. Please note, however, that if you do this ANY DATA YOU HAVE EDITED WILL BE ERASED!!! To save edited data you must directly enter the STORE mode from the EDIT mode, and store the edited data in an appropriate memory location (see CHAPTER VII: STORING VOICE AND PERFORMANCE DATA). If only one error has been made, voice edit buffer data which has been "lost" can be recovered using the RECALL EDIT BUFFER function (see CHAPTER VIII: MEMORY MANAGEMENT, function job P5-J2; RECALL EDIT BUFF.).

---

## **3. The Voice Parameters**

The following is a brief description of each available voice parameter, how it is programmed, and its effect. These parameters are selected by pressing the appropriately labelled (violet labels indicate voice parameters) panel switch while the DX5 is in the EDIT mode.

### OPERATOR SELECT: OP1--OP6

These switches select the operator to be worked on. Only one operator can be selected at a time. Only the parameters for the selected operator will be displayed on the LCD panel.

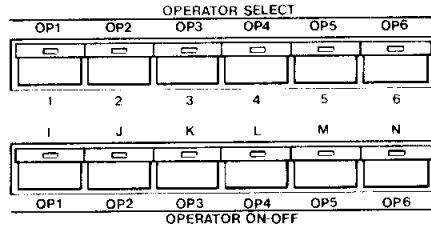

### OPERATOR ON/OFF: OP1--OP6

Individually turns operators 1 through 6 ON or OFF. In many cases a voice will not require all operators in an algorithm. Operators that are not needed should be turned OFF. Also, during the voice creation process. It is a good idea to start with all operators OFF and then turn them ON one at a time as you program and add them to the algorithm.

### ALGORITHM

Permits selection of any of the 32 available algorithms. The desired algorithm number is selected using either the DATA ENTRY control or switches.

```
ALG 18 Freq 1.00 R Rate 80 24 10 50
FBL 5 Detune +0 Level 99 62 0 0
```

### FEEDBACK LEVEL

Feedback can be applied to one operator in each algorithm. Pressing this switch permits setting the amount (level) of feedback which will be applied.

The feedback level range is from 0 to 7. At 0 feedback is OFF, and at 7 maximum feedback is applied.

Data is entered via the DATA ENTRY control or switches.

### OPERATOR OUTPUT LEVEL

Permits setting the output level of the selected operator. The data range is from 0 to 99. At 0 the operator is OFF, and a setting of 99 produces maximum output level from the selected operator.

Varying the output level of an operator which is functioning as a carrier results in a change in the overall level of the sound contributed to the voice by that operator, while varying the output level of an operator which is functioning as a modulator results in a change in the harmonic spectrum produced by the carrier, thereby changing the timbre of the sound.

Data is entered using the DATA ENTRY control or switches.

```
ALG 18 LD LC EP RC RD RS KV AM OPL
FBL 5 0 -L A-1 -L 0 3 2 0 94
```

## EG SELECT EGIPITCH EG

This switch determines whether the envelope generator of the currently selected operator, or the overall pitch envelope generator for the voice (the PITCH EG affects all operators simultaneously) is to be edited using the ENVELOPE GENERATOR switches. Consecutive presses on this switch alternate between the operator and pitch envelope generator displays. Once the desired envelope generator is selected, its values are set using the ENVELOPE GENERATOR switches, described below.

PLG	4	Pitch EG	Rate	95	82	61	81
FEL	7		Level	99	90	0	0

In the case of the PITCH EG, the envelope generator LEVEL 1 through 4 parameters correspond to different frequencies, while the RATE parameters determine the rate of change between frequencies. A LEVEL setting of 50 produces standard pitch, settings below 50 produce a lower pitch, and settings above 50 produce a higher pitch. A setting of 0 produces a pitch 4 octaves below standard pitch and a setting of 99 produces a pitch 4 octaves higher than standard pitch. When the PITCH EG is not to be used, all PITCH EG LEVEL parameters should be set to 50.

## ENVELOPE GENERATOR: R1, R2, R3, R4, L1, L2, L3, L4

These switches select the specific envelope generator parameters to be worked on: RATE 1 through RATE 4, and LEVEL 1 through LEVEL 4.

The data range for both RATE and LEVEL parameters is 0 through 99. For the RATE parameters 0 is the fastest and 99 the slowest. For the LEVEL parameters 0 is minimum and 99 is maximum level.

The following EG curve shows the relationship between the RATE and LEVEL parameters.

Basic EG Pattern

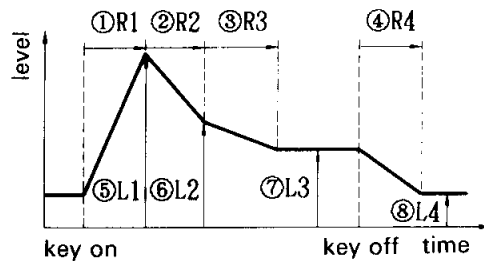

The following EG curves show the parameters for some common instruments.

Piano Carrier Envelope

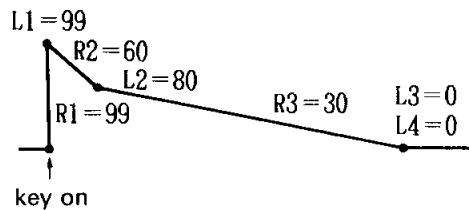

Organ Carrier Envelope

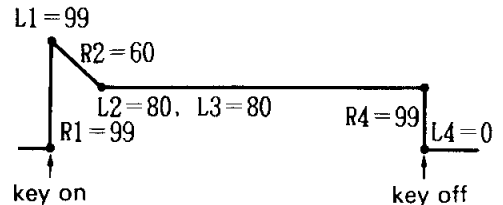

Brass Carrier Envelope

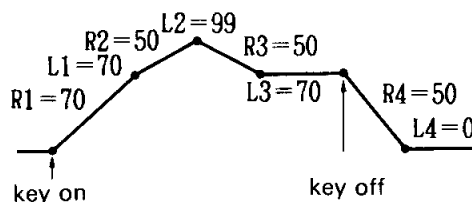

## MODE

Permits selection of the FREQUENCY RATIO or FIXED FREQUENCY oscillator mode for the selected operator.

In the FREQUENCY RATIO mode the selected operator functions normally, varying in frequency according to the key played. The data range in this mode is a ratio from 0.50 through 61.69, relative to standard keyboard pitch. For example, an operator set at 1.00 will produce standard keyboard pitch, while an operator set at 2.00 will produce a pitch one octave higher than standard keyboard pitch. The ratio relationship between operators is a vital element in the creation of FM voices. The actual value is set using the COARSE and FINE switches, described below.

In the FIXED FREQUENCY mode the pitch of the selected operator remains the same whichever key is played. The pitch of the operator is set in terms of an absolute frequency (from 1 Hz to 9770 Hz) using the COARSE and FINE switches, described below. This mode can be used to good effect in the creation of pitchless voices such as bells or noise. Using a low fixed frequency it is also possible to modulate a carrier to produce a vibrato effect.

## COARSE, FINE

These parameters determine the actual frequency of each operator in the FREQUENCY RATIO or FIXED FREQUENCY mode. For operators which function as carriers this determines the actual pitch of the sound produced. For operators functioning as modulators this determines the harmonic spectrum of the sound produced. The data increments vary according to the selected MODE (above).

When the FREQUENCY RATIO mode is selected and FINE is set at minimum, the COARSE data range is from 0.50 to 31.00 in 1.00 increments. When FINE is set at maximum the COARSE data range is from 0.99 to 61.69 in 1.99 increments. Conversely, when COARSE is set at minimum the FINE data range is from 0.50 to 0.99 in 0.01 increments, and when COARSE is set at maximum the FINE data range is from 31.00 to 61.69 in 0.31 increments. The standard DX5 keyboard pitch is 8', therefore in terms of footage: 0.50 = 16', 1.00 = 8', and 2.00 = 4'.

When the FIXED FREQUENCY mode is selected and FINE is set at minimum the COARSE data range is from 1.0 to 1000 Hz in 1/3-octave (4000 cent) increments. When FINE is set at maximum the COARSE data range is from 9.770 Hz to 9770 Hz, also in 1/3-octave increments. Conversely, when COARSE is set at minimum the FINE data range is from 1.0 Hz to 9.770 Hz in 1/30-octave (40 cent) increments, and when COARSE is set at maximum the FINE data range is from 1000 Hz to 9770 Hz, also in 1/30-octave increments.

## DETUNE

This parameter permits slight detuning of the selected operator in relation to the others, making it possible to create richer, fuller voice effects. If detune is applied to carriers, the result is a thick, multi-instrument effect. Applied to modulators the result is a slight periodic variation in timbre-- sometimes similar to a phase shift effect.

The data range is from -7 to +7, for a maximum detuning range of plus or minus 2 cents (1/600th of an octave). At +0 no detune effect is produced.

## SCALING:

LEFT DEPTH, LEFT CURVE, BREAK POINT, RIGHT DEPTH, RIGHT CURVE

ALG	18	LD	LC	EP	RC	RD	RS	KV	AM	OPL
FBL	5	0	-L	A-1	-L	0	3	2	0	94

These five parameters make it possible to vary the EG level of each operator across the keyboard range in a number of ways. This is done to create a more natural, pleasing response with certain voices across the span of the keyboard. The way in which the EG level varies across the keyboard is determined by the LEFT CURVE and RIGHT CURVE parameters which determine the shape of the scaling curve (rising linear, falling linear, rising exponential or falling exponential) on the corresponding sides of the programmable BREAK POINT key. The amount of variation is then determined by the LEFT DEPTH and RIGHT DEPTH parameters. All these parameters are described in the following graph.

#### Level Scaling

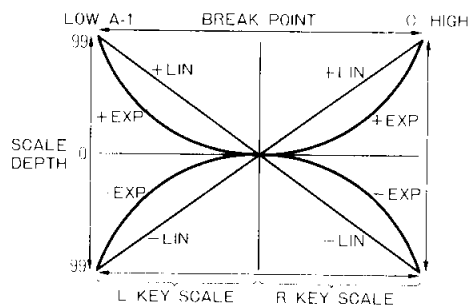

The LEFT CURVE and RIGHT CURVE parameters can be set to +LIN (rising linear), +EXP (rising exponential), -LIN (falling linear) or -EXP (falling exponential).

The LEFT DEPTH and RIGHT DEPTH parameters can be set from 0 to 99. At 0 scaling is effectively OFF (flat response), while at 99 the maximum variation is produced as shown in the above chart.

The BREAK POINT parameter can be set from 0 to 99, corresponding to the keyboard range of A-1 to C8. Each increment corresponds to a semitone step. Since the actual DX5 keyboard range is from E0 to E6 the BREAK POINT range includes keys which

#### SCALING: RATE SCALING

This parameter makes it possible to gradually shorten the overall envelope length (increase EG rate) as higher notes on the keyboard are played. This is particularly useful for simulating the sound of stringed instruments such as piano or guitar, in which the envelope of the higher notes is noticeably shorter than the lower notes. The data range is from 0 to 7. At 0 RATE SCALING is OFF, and at 7 the greatest variation in envelope length is produced. The envelope is gradually shortened between A-1 and F#7 on the keyboard, and all notes above F#7 remain the same length.

#### Rate Scaling

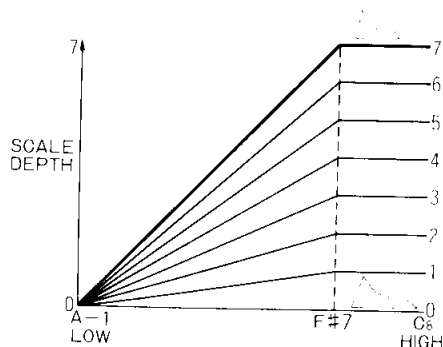

### **SENSITIVITY: KEY VELOCITY**

The DX5 determines how "hard" you have struck a key by sensing the velocity of the key. This parameter determines the DX5's sensitivity to initial key attack. Applied to a carrier, key velocity sensitivity produces a louder sound the harder you play the keyboard, and applied to a modulator the timbre of the sound varies according to how hard you play the keyboard.

The data range is from 0 to 7. At 0 key velocity sensitivity for the selected operator is OFF, and a setting of 7 produces the maximum variation.

### **SENSITIVITY: AMPL. MODULATION**

This sets the operator's sensitivity to LFO AND EG BIAS effects applied via any of the DX5's controllers (modulation wheel, foot controller, breath controller, keyboard after touch: see CHAPTER V: FUNCTION PROGRAMMING).







The application of LFO modulation to a carrier results in tremolo, and applied to a modulator the result is a periodic variation in timbre which is similar to wow effects. When EG BIAS is applied to a carrier the result is volume (expression) control, and applied to a modulator the result is brilliance control.

The data range is from 0 to 3. At 0 amplitude modulation sensitivity is OFF and no LFO or EG BIAS effects can be applied to the selected operator. A setting of 3 produces maximum sensitivity and therefore maximum effect depth.

### **LFO: WAVE**

Permits selection of the low frequency oscillator waveform. The available waveforms are triangle (Tri), sawtooth down (SaD), sawtooth up (SaU), square (Sqr), sine (Sin), and sample/hold (S/H).

#### LFO Waveforms

TRIANGLE   
SAW DOWN   
SAW UP   
SQUARE   
SINE   
S/HOLD 

These waveforms are selected using the DATA ENTRY control or switches.

LFO	Wave	Spd	Dly	PMD	PMS	AMD	Sync
	Tri	37	0	0	4	0	Off

### **LFO: SPEED**

Permits setting the speed of the low frequency oscillator. The data range is from 0 to 99. 0 corresponds to the slowest LFO speed (0.06 Hz), and 99 corresponds to the fastest LFO speed (50 Hz).

### **LFO: DELAY**

Permits setting a delay of between 0 and approximately 3 seconds before the LFO modulation effect begins after a key is played. This is particularly useful for simulating brass instruments, human voice, etc., in which the a vibrato effect is gradually applied after the note has been initiated.

The data range is from 0 to 99. At 0 there is no delay, and a setting of 99 produces a delay of approximately 3 seconds. With longer delay settings the modulation effect begins gradually for a remarkably natural sound.

#### Delay Effect

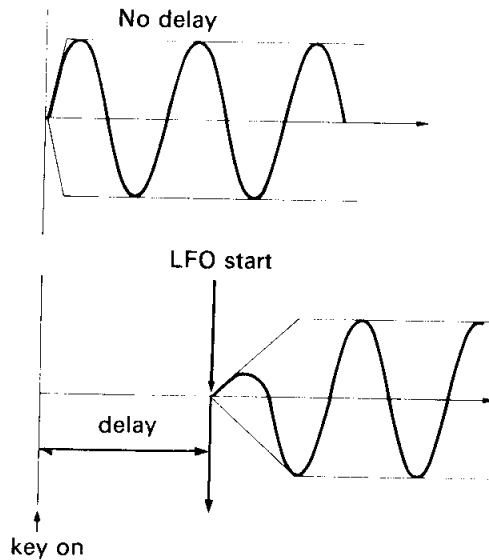

#### **LFO: PM DEPTH**

This parameter sets the depth of pitch variation produced by LFO modulation for all operators simultaneously. This function is independent from pitch modulation produced by the DX5's controllers, and is always ON once set.

The data range is from 0 to 99. At 0 pitch modulation is OFF, and a setting of 99 produces the greatest pitch variation, dependent on the PM SENSITIVITY setting, described below. When the PM SENSITIVITY parameter is set to maximum (7), the maximum pitch variation (PM DEPTH = 99) will be plus and minus 1 octave. Even if this parameter is set to 0, pitch modulation can still be applied via the DX5 controllers.

#### **LFO: PM SENS.**

This parameter sets the sensitivity of all operators to pitch modulation applied either the PM DEPTH parameter, above, or via the DX5 controllers.

The data range is from 0 to 7. At 0 no pitch modulation can be applied, and at 7 the maximum pitch modulation can be achieved. When PMD, above, is set to 99 a setting of 7 produces a plus and minus one-octave pitch variation.

#### **LFO: AM DEPTH**

This parameter sets the depth of amplitude variation (tremolo or wow) produced by LFO modulation for all operators simultaneously. This function is independent from amplitude modulation produced by the DX5's controllers, and is always ON once set.

The data range is from 0 to 99. At 0 amplitude modulation is OFF, and a setting of 99 produces the greatest variation, dependent on the AMPL. MODULATION SENSITIVITY setting. When the AMPL. MODULATION SENSITIVITY parameter is set to maximum (3), the maximum amplitude variation (AM DEPTH = 99) will be plus and minus 42 dB peak-to-peak.

Even if this parameter is set to 0, amplitude modulation can still be applied via the DX5 controllers.

### LFO: KEY SYNC

The beginning of the LFO cycle is normally synchronized with key-on timing. This parameter permits turning this synchronization ON or OFF. All operators are affected simultaneously.

Key Sync On/Off

a. LFO with key sync on.

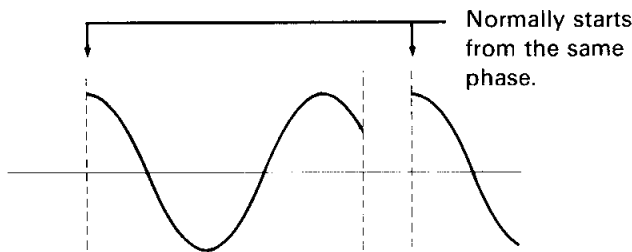

b. LFO with key sync off

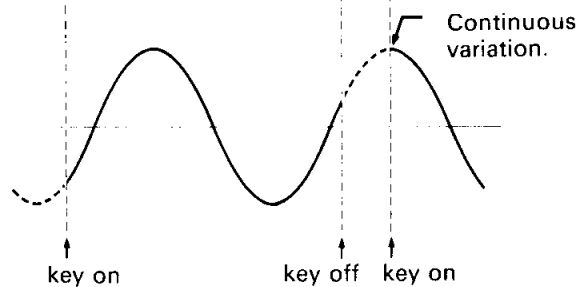

When this parameter is ON, the LFO cycle always begins from the peak of a positive half-cycle (90 degrees phase angle) when a key is played. This produces a clear, consistent attack on all notes.

When LFO KEY SYNC is OFF, the LFO cycle starts from a random point when a key is played. This is the ideal setting when the LFO is being used to create natural-sounding chorus or phasing type effects.

### OSCILLATOR KEY SYNC

Os	K Sync	Transpose	Voice Name
On	-12	***SYN	BFS 2B***

Normally the output waveforms of all operators are synchronized to begin at the same point in the cycle--0 degrees-- when a key is played. This parameter permits turning this synchronization ON or OFF.

When this parameter is ON--the normal condition--the sound of a given voice will be perfectly uniform each time a key is played since all oscillators begin oscillation from the same phase angle.

When this parameter is OFF, the operators begin oscillation at random phase angles, sometimes resulting in a slightly different timbre each time a key is played.



## Operator Waveform Phase and oscillator Key Sync On/Off

a. Oscillator key sync on.

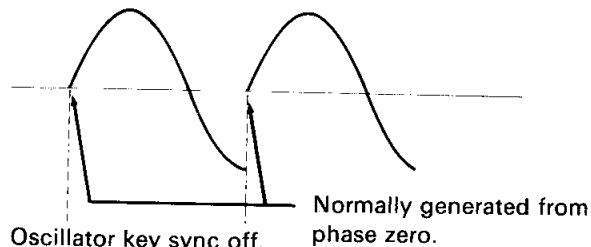

b. Oscillator key sync off.

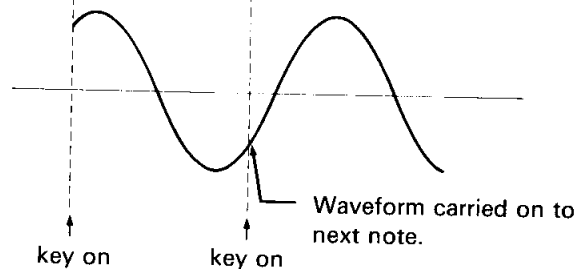

### **TRANSCOPE**

This parameter permits transposing the overall pitch of the keyboard up or down a maximum of two octaves.

The data range is from -24 to +24, with +00 corresponding to standard keyboard pitch. Each increment corresponds to a shift in pitch of one semitone--a setting of +02 would therefore raise the pitch of the entire keyboard a whole tone.

Data can be entered simply by pressing a key on the keyboard within a plus/minus two octave range of C3 (middle C). The pressed key then assumes the pitch of C3 and all other keys are adjusted accordingly. Pressing a key higher than C5 results in a +24 setting, and pressing a key lower than C1 results in a -24 setting. This method of data entry, however, can only be used once after this function is called. Subsequent changes can be made using the DATA ENTRY control and switches.

### **VOICE NAME**

This function can be used to give voices in the voice memory an identifying name. Voice names can be up to 10 characters in length.

When this function is called the flashing cursor will appear at the beginning of the voice name entry space on the lower display line, ready for you to enter the first character. The characters are entered using the cream colored OPERATOR SELECT and OPERATOR ON/OFF switches to the left of the panel and the violet VOICE BANK and VOICE switches. The dash (-), period (.) and space are entered using the brown KEY ASSIGN MODE switches. Note that all these switches have their corresponding characters or numbers printed in white either above or below them. As each character is entered the flashing cursor moves one space to the right, ready for the next character. A character entered over an existing character will replace the original character. To correct errors, the cursor may be moved to the left and right using the -1/NO/OFF and +1/YES/ON switches, respectively.

### **REMEMBER**

If you have edited any of the above voice parameters and wish to keep the edited data, you must enter the STORE mode directly from the EDIT mode and store the voice data from the voice edit buffer into an appropriate internal or external voice memory location. See CHAPTER VII: STORING VOICE AND PERFORMANCE DATA.

---

---

#### **4. Two Approaches to Creating Your Own Voices**

There are two basic approaches which can be taken when programming voices on the DX5. First, you can run through all the available preset voices, choose one that is close to the sound you wish to create, and then edit that voice to create your own. Second, you can "initialize" the the voice edit buffer (see CHAPTER VIII: MEMORY MANAGEMENT, function job P5-1: INITIALIZE MEMORY) setting all parameters to their initial values and begin programming your voice from scratch. The first method, editing a preset voice, is generally a much more efficient approach, provided the sound you want is close to something that already exists. If, however, you are looking for a unique voice that is totally unlike any of the available presets, it is probably best to initialize and start from scratch.

If you choose to program a voice from scratch, you'll need to have a clear memory location (or one containing a voice that you either don't want or have already backed up on a memory cartridge), so that when you've completed programming the voice, you can save it. Since all editing is done in the separate voice edit buffer, nothing is erased while you are actually programming the voice. But when you save the new voice whatever was in that memory location will be erased and replaced by the new data.

---

## CHAPTER VII: STORING VOICE AND PERFORMANCE DATA

---

In this chapter we'll look at the DX5 STORE mode, which includes all the functions you need to store newly created voices or performance combinations in an appropriate internal or external memory location.

When you create or edit a voice or performance combination, the editing is done in the DX5's voice edit buffer or performance edit buffer, respectively (See CHAPTER II: VOICE AND PERFORMANCE MEMORY CONFIGURATION). All the store functions are concerned with moving data from either the voice edit buffer or the performance edit buffer--or both--to an internal or external memory location.

Three basic functions are accessible in the STORE mode: STORE ALL, STORE VOICE and STORE PERFORMANCE. Each of these will be discussed in detail, below.

The STORE mode is accessed by pressing the cream colored STORE switch on the bottom row of the rightmost group of buttons on the DX5 panel. The three STORE mode functions are then called in succession by pressing the -1/NO/OFF switch.

### STORE ALL

The STORE ALL function simultaneously stores the contents of the A and B channel voice and performance edit buffers into the currently selected voice and performance memory locations.

The currently selected KEY ASSIGN MODE and INTERNAL/CARTRIDGE memory status is also stored in the performance memory. With this function the data is always returned to the memory locations from which it was originally called.

If the an internal voice memory is selected, then the voice data will be stored back into the same internal voice memory location after editing. Likewise, if an external RAM cartridge voice is selected, then the voice data will be stored back into the same RAM cartridge memory location (assuming that the RAM cartridge memory protect switch is OFF). The same applies to the performance memories: a performance combination called from the internal performance memory will be stored back into the same internal memory location, and a performance combination called from an external RAM performance cartridge will be stored back into the same RAM cartridge memory location.

STORE ALL is the first function called when the STORE mode is entered. The display will look like this:

```
STORE FROM>> CURRENT EDITING
ALL    TO>> CURRENT SELECTED ?
```

The STORE ALL function is executed simply by pressing the +1/YES/ON button. PROTECT MEMORY WRITE (function job P7-J1) must be OFF or an error message will appear.

If the -1/NO/OFF switch is pressed, the next STORE mode function will be called.

### STORE VOICE

This function is called by pressing the -1/NO/OFF switch once after entering the STORE mode. The STORE VOICE function permits storing voice data from the voice edit buffer to a specified internal or external voice memory location. Voice data called from either the internal or external cartridge voice memory can be stored in a different memory location. A voice called from an external voice cartridge may be stored in an internal voice memory, or vice versa; a voice called from channel A may be stored in a channel B voice memory, and vice-versa; etc.

If the STORE VOICE function is called directly from the EDIT mode, the current edited contents of the voice edit buffer can be stored in any location. In this case the display will look like this:

```
STORE   FROM>> EDITING TRUMPET B
VOICE   TO>> INT. B2-8 TRUMPET B
```

If the STORE VOICE function is called directly from the normal PLAY mode, then the last selected PLAY mode voice can be stored in any new voice memory location. In this case the display will look like this:

```
STORE   FROM>> INT. B2-8 TRUMPET B
VOICE   TO>> INT. B2-8 TRUMPET B
```

In either case, the destination voice memory can then be selected as desired: select an internal voice memory location in the same channel as the source voice, an internal voice memory location in the other channel, an external voice memory location in RAM voice cartridge A or B. The selected destination voice memory location will be displayed on the bottom line of the display. To execute the STORE VOICE command, make sure that PROTECT MEMORY WRITE (function job P7-J1) is OFF and that the RAM cartridge memory protect switch is OFF if the voice is to be stored to an external voice cartridge, then press the +1/YES/ON switch. The STORE mode will be automatically exited after the STORE VOICE function has been executed.

### **STORE PERFORMANCE**

This function is called by pressing the -1/NO/OFF switch twice after entering the STORE mode. The STORE PERFORMANCE function permits storing performance memory data in the performance edit buffer to any specified performance memory location. The current KEY ASSIGN MODE and INTERNAL/CARTRIDGE memory status is also stored to the performance memory.

Performance data called from either the internal or external cartridge performance memory can be stored in a different performance memory location. A performance combination called from an external performance cartridge, for example, may be stored in an internal performance memory, or vice versa; a performance combination called from an internal memory location may be stored in a different internal performance memory location, etc.

The contents of the performance edit buffer when the STORE PERFORMANCE function is called becomes the source data. This could simply be a performance combination selected from the internal or external cartridge performance memory, or the same data could be edited in the FUNCTION mode prior to calling the STORE PERFORMANCE function.

When the STORE PERFORMANCE function is called the display will look something like this:

```
STORE   FROM>> CURRENT STRINGS & ?
PERFORMANC TO>> INT. P2-8 STRINGS & ?
```

The destination performance memory--internal or cartridge--can then be selected in the normal way. If a RAM performance cartridge is used, it must be plugged into the CARTRIDGE A slot, and its memory protect switch must be OFF. The PROTECT MEMORY WRITE (function job P7-J1) must also be OFF to perform this function. The STORE PERFORMANCE function is then activated by pressing the +1/YES/ON switch. The STORE mode will then be automatically exited.

**NOTE:**

If the performance data is to be stored to an external performance RAM cartridge, the cartridge must be plugged into the CARTRIDGE A slot and accessed as described in CHAPTER IV: PLAYING THE PERFORMANCE COMBINATIONS, 3. Accessing a Performance Cartridge.

---

---

## CHAPTER VIII: MEMORY MANAGEMENT

---

---

This section covers function job groups P4 through P7: the MEMORY MANAGEMENT section. For information on accessing these jobs see sections 1, 2 and 3 of CHAPTER V: FUNCTION PROGRAMMING.

In the MEMORY MANAGEMENT job groups P4 through P7 the bottom LCD line will display prompts allowing you to choose between specified memory operations and select "subjobs". Each job may contain several subjobs which are selected using the DATA ENTRY - 1 switch.

### P4-J1: COPY OPERATOR DATA

```
Func P4B Copy Temp
Copy envelope data From OP1 TO OP1 OK?
```

This function permits copying the data from one operator to another, within the same voice and channel. This capability can minimize the time and effort required when programming new voices by permitting similar operator data to simply be copied to other operators, and then modified as desired. The COPY OPERATOR DATA job consists of two "subjobs": "Copy oscillator data" and "Copy envelope data".

The COPY OSCILLATOR DATA subjob copies all four operator oscillator parameters (MODE, DETUNE, COARSE, and FINE), while the COPY ENVELOPE DATA subjob copies all operator envelope data (R1 through R4, L1 through L4, and all level and rate scaling parameters).

The two subjobs are alternately called by pressing the - 1/NO/OFF switch, and are identified on the bottom display line. Immediately following the subjob identifier you will see something like "From OP1 to OP1. OK?", indicating the source and destination operator numbers.

To use this function call any function other than COPY OP DATA and use the OPERATOR SELECT switches to select the source operator (the operator from which the data will be copied). Then call the COPY OP DATA function and select either the COPY OSCILLATOR DATA or COPY ENVELOPE DATA subjob using the -1/NO/OFF switch. The "From OPX to OPX. OK?" portion of the display will now show the operator number just selected for both the source and destination operators. Use the OPERATOR SELECT switches again to select the destination operator--this will be confirmed on the LCD display. When the desired source and destination operator numbers have been specified, press the +1/YES/ON switch to execute the actual copy operation.

This function can be used independently for voice generator channels A and B. The channel in which this function is to be used can be selected by pressing any violet BANK or VOICE selector in the corresponding channel. The selected channel will be indicated immediately following the function switch number at the left of the top line of the LCD display--e.g. "Func P4A" or "Func P4B".

### P4-J2: SAVE TEMP. OPERATOR

```
Func P4A Copy Temp
SUBJOB1: Temporary save OP data? xxx
```

This function makes it possible to copy data from one operator to another operator in a different voice or channel, via a special temporary memory location. This function consists of two subjobs: "Temporary save OP data" and "Extract temporary OP data". Once the SAVE TEMP. OPERATOR function is called, the two subjobs are alternately called by pressing the -1/NO/OFF switch.

The TEMPORARY SAVE OP DATA subjob simply saves all parameters of the selected operator (OPERATOR SELECT switches) into the temporary operator memory, and the EXTRACT TEMPORARY OP DATA subjob calls all data in the temporary operator memory into the selected operator.

To use this function first call SAVE TEMP. OPERATOR--the "Temporary save OP data" subjob will automatically be selected. Next select the source operator using the OPERATOR SELECT switches. To save the data, press the +1/YES/ON switch. "+++" will appear on the LCD to indicate that the data has been stored in the temporary operator memory. Next select the "Extract temporary OP data" subjob by pressing the -1/NO/OFF switch (note that "+++" is still visible to the right of the bottom display line, indicating that the temporary operator memory contains data which can be "extracted"). Then select the destination channel (EDIT A and EDIT B switches), the destination voice (BANK and VOICE switches) and the destination operator (OPERATOR SELECT) switches. Finally, press +1/YES/ON to call the data from the temporary operator memory and store it in the selected operator.

This function can be used independently for voice generator channels A and B. The channel in which this function is to be used can be selected by pressing any violet BANK or VOICE selector in the corresponding channel. The selected channel will be indicated immediately following the function switch number at the left of the top line of the LCD display--e.g. "Func P4A" or "Func P4B".

### P5-J1: INITIALIZE MEMORY

```
Func P5B Init   Recall
SUBJOB1: Initialize voice edit-buffer?
```

This function incorporates two subjobs: "Initialize voice edit buffer" and "Initialize perform. edit buffer". The INITIALIZE VOICE EDIT BUFFER subjob sets all voice parameters in the voice edit buffer to their "initial" values, giving you a "clean slate" for the creation of totally new voices. The initial voice parameters are as follows:

#### ≡ INITIALIZE VOICE DATA LIST

```
ALGORITHM ----- PATTERN ----- 1
                      FEEDBACK ----- 0
OSCILLATOR ----- MODE ----- OP 1~OP 6 -- F.RATIO
                      DETUNE ----- OP 1~OP 6 -- 0
                      FREQUENCY COARSE - OP 1~OP 6 -- 1.00
                      FREQUENCY FINE --- OP 1~OP 6 -- 1.00
EG ----- RATE 1~4 ----- OP 1~OP 6 -- 99
                      LEVEL 1~3 ----- OP 1~OP 6 -- 99
                      LEVEL 4 ----- OP 1~OP 6 -- 0
PITCH EG ----- RATE 1~4 ----- 99
                      LEVEL 1~4 ----- 50
LEVEL SCALING ----- BREAK POINT ----- OP 1~OP 6 -- 0 = A-1
                      CURVE L · R ----- OP 1~OP 6 -- LIN
                      DEPTH L · R ----- OP 1~OP 6 -- 0
RATE SCALING ----- OP 1~OP 6 -- 0
SENSITIVITY ----- KEY VELOCITY ----- OP 1~OP 6 -- 0
                      AMPL.MODULATION --- OP 1~OP 6 -- 0
OPERATOR OUTPUT LEVEL ----- OP 1 ----- 99
                      OP 2~OP 6 --- 0
```

LFO	WAVE	TRIANGLE
	SPEED	35
	DELAY	0
	PMD	0
	PMS	3
	AMD	0
	KEY SYNC	ON
OSCILLATOR KEY SYNC		ON
TRANSEPOSE		+00=C3
VOICE NAME		<input type="checkbox"/> =BLANK

The INITIALIZE PERFORMANCE EDIT BUFFER does the same thing for the performance edit buffer, making it easier to program a totally new set of performance parameters. The initial performance parameters are as follows:

PORTAMENTO	PORTAMENTO / GLISSANDO	PORT
	PORTAMENTO MODE	RETAIN
	PEDAL ASSIGN	ON
	TIME	0
OUTPUT LEVEL ATTENUATE		7
PROG. OUTPUT ASSIGN		OFF
SUSTAIN PEDAL ASSIGN		ON
MODULATION WHEEL	SENSITIVITY	15
	ASSIGN	001 = PMD
FOOT CONTROLLER	SENSITIVITY	0
	ASSIGN	000
BREATH CONTROLLER	SENSITIVITY	0
	ASSIGN	000
AFTER TOUCH	SENSITIVITY	0
	ASSIGN	000
SPLIT POINT		C3
KEY SHIFT		+00=C3
PERFORMANCE NAME		<input type="checkbox"/> =BLANK

Once the INITIALIZE MEMORY function is called, the two subjobs are alternately called by pressing the -1/NO/OFF switch. The selected subjob is then executed by pressing the +1/YES/ON switch. The PROTECT MEMORY WRITE function must be OFF to use the INITIALIZE function, otherwise an error message will be generated.

New voices created in the voice or performance edit buffers must be saved to a voice or performance memory location after programming, otherwise they will be erased the next time a voice or performance combination is called.

After the INITIALIZE VOICE EDIT BUFFER subjob is executed, the DX5 will automatically enter the voice EDIT mode once the FUNCTION switch is disengaged, ready to program a new voice.

This function can be used independently for voice generator channels A and B. The channel in which this function is to be used can be selected by pressing any violet BANK or VOICE selector in the corresponding channel. The selected channel will be indicated immediately following the function switch number at the left of the top line of the LCD display--e.g. "Func P5A" or "Func P5B".



## P5-J2: RECALL EDIT BUFFER

```
Func P5B Init   Recall  
Recall Previous Edit-buffer data  OK?
```

This function makes it possible to recover voice edit buffer data which may have been "lost" due to erroneous operation during the edit process. This can happen, for example, if a new voice memory location is called while in the COMPARE mode, or if the voice initialize function is activated after the EDIT mode has been activated. A second utility memory is provided--in addition to the voice edit buffer--in which the "lost" data is retained. The RECALL EDIT BUFFER function simply calls the data from this second utility memory back into the main voice edit buffer. Data will not be recoverable, however, if two "losses" are incurred in a row, since only the latest voice edit buffer is retained. No facility is provided for recovery of data lost from the performance edit buffer.

To use this function, activate the FUNCTION mode, call the RECALL EDIT BUFFER job and press the +1/YES/ON switch to execute the recall operation. The FUNCTION mode will automatically be exited and the EDIT mode re-entered, ready for continued editing.

## P6-J1: SAVE TO CARTRIDGE

```
Func P6 Save   Load   Format  
Save all voices from INT-A into EXT-A?
```

This function includes three subjobs: "Save all voices from INT-A to EXT A", "Save all voices from INT-B to EXT-B", and "Save all performance memories to EXT-A". The three subjobs are called in succession by pressing the -1/NO/OFF key.

The "Save all voices from INT-A to EXT-A" subjob permits saving all internal channel A voice memories to an appropriately formatted external RAM1 voice memory cartridge plugged into the CARTRIDGE A slot. The "Save all voices from INT-B to EXT-B" subjob saves all internal channel B voice memories to an appropriately formatted RAM1 voice memory cartridge plugged into the CARTRIDGE B slot. And the "Save all performance memories to EXT-A" saves all internal performance memories to an appropriately formatted RAM1 performance memory cartridge plugged into the CARTRIDGE A slot. In all of the above cases the RAM1 cartridge memory protect switch must be turned OFF before this function will operate.

To use this function select the desired subjob and insert an appropriately formatted cartridge into the appropriate cartridge slot. Press the +1/YES/ON switch to begin. The LCD will ask you to confirm your intention to carry out the save function with "Change your mind?". If your answer -1/NO OFF to this prompt (meaning "no, I haven't changed my mind") the DX5 will then remind you to insert the cartridge in the appropriate slot: "Insert cartridge in A" (or "B", depending on which subjob you have selected). Press the +1/YES/ON switch to continue. The display will now read "Ready?". If you are, press the +1/YES/ON button to actually execute the save command. The "Writing" message will appear while the data is being saved, which will change to the "Save completed!" message once the save has been accomplished.

\*\* Be sure to turn the cartridge memory protect switch back ON after a successful save operation.

## P6-J2: LOAD FROM CARTRIDGE

```
Func P6 Save   Load   Format  
Load all voice from EXT-A into INT-A?
```

This function includes three subjobs: "Load all voices from EXT-A to INT-A", "Load all voices from EXT-B to INT-B", and "Load performance memories from EXT-A".

The three subjobs are called in succession by pressing the -1/NO/OFF key. The "Load all voices from EXT-A to INT-A" subjob permits loading all internal channel A voice memories from an external ROM or RAM1 voice memory cartridge plugged into the CARTRIDGE A slot. The "Load all voices from EXT-B to INT-B" subjob loads all internal channel B voice memories from an external ROM or RAM1 voice memory cartridge plugged into the CARTRIDGE B slot. And the "Load performance memories from EXT-A" subjob loads all internal performance memories from an external ROM or RAM1 performance memory cartridge plugged into the CARTRIDGE A slot. In all of the above cases the PROTECT MEMORY WRITE function must be turned OFF before this function will operate.

To use this function select the desired subjob and insert an appropriate cartridge into the appropriate cartridge slot. Press the +1/YES/ON switch to begin. The LCD will ask you to confirm you intention to carry out the load function with "Change your mind?". If your answer -1/NO OFF to this prompt (meaning "no, I haven't changed my mind) the DX5 will then remind you to insert the cartridge in the appropriate slot: "Insert cartridge in A" (or "B", depending on which subjob you have selected). Press the +1/YES/ON switch to continue. The display will now read "Ready?". If you are, press the +1/YES/ON button to actually execute the load command. The "Load completed!" message will appear when the load operation has been completed.

\*\* Be sure to turn the PROTECT MEMORY WRITE function back ON after a successful load operation.

### **P6-J3: CHANGE CARTRIDGE FORMAT**

Func P6	Save	Load	Format	
Format cartridge(A). Type 00 to ??				OK?

The DX5 uses the same external RAM1 cartridges for storage of voice and performance memory data. The CHANGE CART. FORMAT function electronically "labels" the cartridge for either voice or performance memory storage, so that the DX5 can recognize the cartridge type and access it properly. Voice data cannot be stored on a cartridge formatted for performance memory, and vice-versa. When this function is used, all data that was previously in the cartridge is erased. RAM1 cartridges are initially formatted for voice memory, so a new cartridge need not be formatted if voice memory is to be stored (format code 00).

To use this function, first turn the cartridge's memory protect switch OFF, and insert it into the CARTRIDGE A slot on the DX5 panel. Next call the CHANGE CART. FORMAT function; the lower display line will then read "Format cartridge(A). 00 to ?? OK?". The cursor will be over the first question mark. The new cartridge format must then be entered using the character/number keys. The format for voice storage is 00, and for performance storage it is 01. You will therefore only need to use the "0" (EG SELECT. EG/PITCH EG) and "1" (OPERATOR SELECT 1) keys. Other codes can be entered, but the resulting format will be meaningless to the DX5. Once the desired format code has been entered, press the +1/YES/ON switch to go on to the next step. The DX5 will ask you to confirm your intention to format the cartridge with "You lose original data. Are you sure?". Press +1/YES/ON to go on. The DX5 will double-check with "New format number is 01. OK?" (if you had selected the performance format--01). If you are sure, then press +1/YES/ON again to continue. The DX5 will respond with the final check "Execute formatting of cartridge-A. OK?". Press +1/YES/ON to actually execute the format command. A -1/NO/OFF response to any of the above check prompts immediately exits the FUNCTION mode without performing the format command.

The formatting function takes a few seconds, so while it is under way the display will read "Formatting!". Once the operation has been completed the display will read "Formatting completed!".

This function can not be used to change the format of the supplied ROM cartridges.

### **P7-J1: PROTECT MEMORY WRITE**

Func P7	M Prot	M clear	Battery	
Internal memory write protect			On	

When this function is ON, the internal voice and performance memories are write-protected, and cannot be accidentally written over using any of the STORE or LOAD functions.

When OFF, the LOAD or STORE functions can be used to write new data to the voice and performance memories.

PROTECT MEMORY WRITE is automatically turned ON each time the DX5 power switch is turned ON.

### **P7-J2: CLEAR ALL MEMORY**

This function initializes all internal voice and performance memories at once (see P5-J1: INITIALIZE MEMORY for initialized data charts). Using this function completely erases all data in memory and sets all parameters to their initial values. Cartridge data can not be erased using this function.

To use this function first call CLEAR ALL MEMORY, then press the +1/YES/ON switch to go on to the next step. The LCD display will respond with "You lose all data. OK?". Press +1/YES/ON to confirm, or -1/NO/OFF to exit the FUNCTION mode. If you pressed +1/YES/ON, the DX5 will then check again--just to be sure--with the "Change your mind?" display. Respond with -1/NO/OFF to continue, or +1/YES/ON (meaning yes, I've changed my mind!) to exit the function mode without clearing. The DX5 will then ask you--one last time--"Are you sure?" (persistent, but an important safeguard for your valuable voice and performance data). If you answer +1/YES/ON, the actual clear operation will be executed. A -1/NO/OFF response will exit the FUNCTION mode without clearing.

\*\* The PROTECT MEMORY WRITE function must be turned OFF before using CLEAR ALL MEMORY.

### **P7-J3: CHECK BATTERY**

The DX5 incorporates a special backup battery system which retains all voice and performance memory data even while the instrument is turned OFF and unplugged from the AC power source. This special battery features an extra-long life, but should be checked periodically to ensure the safety of your data.

Simply calling this function displays the current voltage of the backup battery. Any voltage higher than 2.2 volts is normal. If the battery voltage drops below 2.2 volts, however, CHANGE THE BATTERY AS SOON AS POSSIBLE!

Since a special type of battery has been used, replacement **MUST BE PERFORMED BY A QUALIFIED YAMAHA DEALER!** The backup battery is absolutely **NOT USER REPLACEABLE!**

When the DX5 is shipped from the factory, battery voltage is greater than 3 volts.

---

---

## CHAPTER IX: MIDI FUNCTIONS

---

---

This section covers the functions in function job group P8: the MIDI functions. For more information about accessing these functions see sections 1, 2 and 3 of CHAPTER V: FUNCTION PROGRAMMING.

In the MIDI job group P8 the bottom LCD line will display prompts allowing you to choose between specified MIDI operations and select "subjobs". Each job may contain several subjobs which are selected using the DATA ENTRY -1 switch.

Note that the DX5 can be set to transmit on any MIDI channel (1 ~ 16). Receiving instruments and equipment must therefore be set to receive on the same channel, or all channels (OMNI mode ON). The DX5 can be set to receive on all channels simultaneously by turning the OMNI mode ON (P8-J2, SUBJOB 4). If the OMNI mode is OFF, specific reception channels can be set independently for the channel A and channel B voice generators using the SOURCE SELECT function (B2-J2).

### **P8-J1: MIDI ON/OFF, REMOTE SEQUENCE**

Func P8 Midi	Status	Disp
MIDI switch		

This function turns transmission and reception via the DX5's MIDI terminals ON or OFF. When ON the DX5 can transmit or receive MIDI data to or from external MIDI equipment. When OFF, no MIDI data interchange is possible.

This function is turned ON or OFF using the DATA ENTRY control or switches. Pressing the -1/NO/OFF switch alternates between the ON and OFF states. The first press on the +1/YES/ON switch activates the ON state, and the next press on the +1/YES/ON switch activates the REMOTE SEQUENCE function. When this function is activated, the lower display line will read "Sequence control: NO = pause → stop, YES = start. In this mode it is possible to transmit STOP, PAUSE and START commands to a sequencer or music computer connected to the DX5. Pressing the +1/YES/ON switch from the "stop" condition—indicated by the cursor over the "s" in "stop" (the initial condition when this mode is activated)—sends the START signal, initializing sequencer playback. Pressing the -1/NO/OFF switch from the "start" condition transmits a STOP signal, stopping sequencer playback. If the +1/YES/ON switch is then pressed from this PAUSE mode, sequencer playback will continue from the point at which it was stopped. If, however, the -1/NO/OFF switch is pressed from the "pause" condition, the full "stop" mode will be entered and subsequently sending a START signal will cause sequencer playback to begin from the beginning of the programmed piece.

### **P8-J2:SET STATUS**

Func P8 Midi	Status	Disp
SUBJOB1: Basic event data output	On	

This function incorporates five subjobs. Subjobs 1, 2 and 3 turn communication of a specific MIDI data group ON or OFF.

#### **SUBJOB 1:**

Basic event data output. This subjob turns MIDI basic event data group communication ON or OFF. Pressing the +1/YES/ON switch alternates between the ON and OFF states. Pressing the -1/NO/OFF switch selects the next subjob. When ON, communication of the following data is enabled.

- (a) KEY ON/OFF: Key on/off timing.
- (b) KEY NUMBER: The MIDI number of the key played.
- (c) KEY VELOCITY: Initial touch response data.

- (d) SUSTAIN FOOT SW: Sustain footswitch on/off status.
- (e) PITCH BEND WHEEL: Pitch bend wheel position.

**NOTE:**

Basic event data is generally common to all keyboards and equipment compatible with the MIDI system. Due to differences in the features provided by some manufacturers, however, complete compatibility can not be guaranteed.

**SUBJOB 2:**

Other event data output. This subjob turns MIDI other event data group communication ON or OFF. Pressing the +1/YES/ON switch alternates between the ON and OFF states. Pressing the -1/NO/OFF switch selects the next subjob. When ON, communication of the following data is enabled.

- (a) MODULATION WHEEL: Modulation wheel position.
- (b) FOOT CONTROLLER: Foot controller position.
- (c) AFTER TOUCH: Keyboard aftertouch pressure.
- (d) BREATH CONTROLLER: Breath controller pressure.
- (e) PORTAMENTO CONTROL: Portamento control position.
- (f) PORTAMENTO FOOT SW: Portamento footswitch on/off status.
- (g) PROGRAM CHANGE: Voice and performance memory selection. Whether the voice or performance memory number is sent in the PROGRAM CHANGE data is determined by SUBJOB 5: PROGRAM CHANGE MODE, below. Voice numbers can be received in the PLAY and FUNCTION modes, while performance memory numbers can only be received in the PLAY mode.
- (h) DATA ENTRY CONTROL: DATA ENTRY control position.
- (i) DATA ENTRY SW: DATA ENTRY +1 and -1 switch status. DATA ENTRY SW. data can be received by the DX5 in the EDIT and FUNCTION modes.

**NOTE:**

Other event data is generally common to all keyboards and equipment compatible with the MIDI system. Due to differences in the features provided by some manufacturers, however, complete compatibility can not be guaranteed.

**SUBJOB 3:**

Aftertouch data output. This subjob turns output of DX5 aftertouch data ON or OFF. Pressing the +1/YES/ON switch alternates between the ON and OFF states, while pressing the -1/NO/OFF switch goes on to the next subjob. In situations where the DX5 is being used to input data into a digital sequence recorder such as the Yamaha QX1 or QX7, even slight changes in key pressure can result in a tremendous amount of data being sent to the sequencer and stored in its memory. This can use up a considerable amount of memory space. This subjob permits turning aftertouch data transmission OFF to prevent this problem.

**SUBJOB 4:**

System exclusive communication. This subjob turns MIDI system exclusive communication group data ON or OFF. Pressing the +1/YES/ON switch alternates between the ON and OFF states. Pressing the -1/NO/OFF switch selects the next subjob. When ON, communication of the following data is enabled:

- (a) ONE BULK DATA: Voice and performance edit buffer contents. This data is output by pressing the desired voice or performance memory button while holding the data entry +1/YES/ON switch. ONE BULK DATA received by the DX5 is stored in the corresponding edit buffers.

- (b) **32 VOICE BULK DATA:** The entire contents of one voice memory channel. The TRANSMIT DATA (P8-J3) job is used to transmit an entire channel of voice data. 32 VOICE BULK DATA received by the DX5 is stored in the corresponding voice memory channel.
- (c) **64 PERFORMANCE BULK DATA:** The entire contents of the performance memory. The TRANSMIT DATA (P8-J3) job is used to transmit all 64 performance memory locations. 64 PERFORMANCE BULK DATA received by the DX5 is stored in the internal performance memory.
- (d) **EDIT PARAMETER CHANGE:** Voice parameter data. Any voice parameter changes made in the EDIT mode are transmitted in real time. EDIT PARAMETER CHANGE data can be received by the DX5 when the EDIT mode is engaged.
- (e) **PERFORMANCE MEMORY PARAMETER CHANGE:** Performance memory parameter data. Any function parameter changes made in the FUNCTION mode will be transmitted in real time. PERFORMANCE MEMORY PARAMETER CHANGE data can be received by the DX5 when the FUNCTION mode is engaged.

**NOTE:**

System exclusive communication data is only useable with compatible Yamaha MIDI equipment.

**SUBJOB 5:**

Omni mode. When the Omni mode is ON, MIDI data reception is enabled on all 16 MIDI channels. When OFF, MIDI reception is only possible on the channel designated by the SOURCE SELECT function job (B2-J2). Pressing the +1/YES/ON switch alternates between the ON and OFF states. Pressing the -1/NO/OFF switch select the next subjob. The Omni mode can be set independently for the channel A and channel B voice generators. Select the desired channel by pressing any violet voice selector in the appropriate channel.

**SUBJOB 6:**

MIDI transmission channel. This subjob permits selection of which MIDI channel—from 1 to 16—the DX5 will transmit all MIDI data on. The desired MIDI channel is selected using the DATA ENTRY control. Any instruments or other MIDI equipment receiving data from the DX5 must be set either to receive on the same channel that the DX5 is set to transmit on, or to receive in the OMNI mode—i.e. reception is possible on all channels simultaneously.

**SUBJOB 7:**

Program change mode. This subjob selects whether the PROGRAM CHANGE data included in the MIDI other event data group will consist of voice or performance memory numbers. Pressing the +1/YES/ON switch alternates between the VOICE and PERFORMANCE modes. Pressing the -1/NO/OFF switch returns to subjob 1.

**SUBJOB 8:**

YES/NO switch assign. This subjob determines the MIDI code which will be output from the MIDI OUT terminal when the -1/NO/OFF or +1/YES/ON switches are pressed during the PLAY mode. The data range is from OFF to 64 through 95. If MIDI code 64 is selected, for example, when the +1/YES/ON switch is pressed in the PLAY mode a MIDI 64-ON signal will be transmitted. If the -1/NO/OFF switch is pressed a 64-OFF signal will be transmitted. This corresponds to MIDI sustain ON and sustain OFF signals. Currently only codes 64 (sustain ON/OFF)

and 65 (portamento ON/OFF) can be received by most MIDI equipment. The remaining range (66~95) is reserved for future functions. When this subjob is OFF, no signal will be transmitted by the YES or NO keys in the PLAY mode.

**P8-J3:**

**TRANSMIT DATA**

Func	P8 Midi	Status	Dump
SUBJOB1:	Dump	all voices	in bank A?

This function incorporates three subjobs which are concerned with the transmission of the internal voice or performance memory data. To use any of these subjobs the MIDI ON/OFF function (P8- J1) must be ON, and SYSTEM EXCLUSIVE COMMUNICATION (P8-J2, SUBJOB 3) must be ON.

**SUBJOB 1:**

Dump all voices in bank A. When this subjob is selected, pressing the +1/YES/ON switch begins transmission of the entire contents of the channel A voice memory. The transmitted data is loaded into the corresponding voice memory channel of the receiving instrument. Pressing -1/NO/OFF selects the next subjob.

**SUBJOB 2:**

Dump all voices in bank B. When this subjob is selected, pressing the +1/YES/ON switch begins transmission of the entire contents of the channel B voice memory. The transmitted data is loaded into the corresponding voice memory channel of the receiving instrument. Pressing -1/NO/OFF selects the next subjob.

**SUBJOB 3:**

Dump all performance data. When this subjob is selected, pressing the +1/YES/ON switch begins transmission of the entire contents of the performance memory. The transmitted data is loaded into the performance memory of the receiving instrument. Pressing -1/NO/OFF returns to subjob 1.

The OTHER EVENT DATA OUTPUT status of the receiving instrument should be OFF when using this function.

**SUBJOB 4:**

Transmit Omni off. When this subjob is selected, pressing the +1/YES/ON switch initiates transmission of an "omni mode OFF" signal, turning the Omni mode of the receiving equipment OFF if it is capable of receiving this information.

**SUBJOB 5:**

Transmit Omni on. When this subjob is selected, pressing the +1/YES/ON switch initiates transmission of an "omni mode ON" signal, turning the Omni mode of the receiving equipment ON if it is capable of receiving this information.

**SUBJOB 6:**

Transmit Mono on. When this subjob is selected, pressing the +1/YES/ON switch initiates transmission of a "mono mode ON" signal, activating the MONO mode of the receiving equipment if it is capable of receiving this information.

**SUBJOB 7:**

Transmit Poly on. When this subjob is selected, pressing the +1/YES/ON switch initiates transmission of a "poly mode ON" signal, activating the POLY mode of the receiving equipment if it is capable of receiving this information.

---

---

# CHAPTER X: GENERAL SPECIFICATIONS

---

---

## Keyboard

- 76KEY E0 ~ G6
- TOUCH CONTROL: KEY VELOCITY, AFTER TOUCH

## Sound Source

- FM TONE GENERATOR (6 OPERATOR x A-B)

## Simultaneous Note Output

- POLYPHONIC: SINGLE 32/DUAL 16/SPLIT 16 + 16
- MONOPHONIC: SINGLE 1/DUAL 1/SPLIT 1 + 1

## Internal Voice Memory

- VOICE MEMORY: 4 BANK x 8 VOICE x A-B
- PERFORMANCE MEMORY: 8 BANK x 8 PERFORMANCE

## Controls

- VOLUME: VOLUME SLIDER, BALANCE SLIDER, PHONES VOLUME
- EFFECT CONTROLLER: PORTAMENTO TIME SLIDER, PITCH BEND WHEEL, MODULATION WHEEL
- DATA ENTRY: DATA ENTRY SLIDER, +/-SW,
- MEMORY & PARAMETER SELECT: VOICE MEMORY/EDIT PARAMETER, PERFORMANCE MEMORY/FUNCTION, CARTRIDGE A-B
- KEY ASSIGN MODE: SINGLE, DUAL, SPLIT
- MODE SELECTOR: EDIT/COMPARE, FUNCTION, STORE
- OTHER: OPERATOR SELECT, OPERATOR ON/OFF, DISPLAY SELECT (EG/PITCH EG)

## Display

- LC DISPLAY: 40 CHARACTERS x 2 LINES

## Connection Terminals/Interface

- AUDIO OUTPUT: OUTPUT A-B-P (PHONE JACK, XLR TYPE balanced) PHONES (STEREO PHONE JACK 8 ~ 150  $\Omega$ )
- CONTROL JACK: MODULATION, VOLUME, SUSTAIN ON/OFF, PORTAMENTO ON/OFF
- INTERFACE: MIDI IN-OUT-THRU, CARTRIDGE INSERT A-B

## Edit Parameters

### ALGORITHM

- ALGORITHM, FEEDBACK

### OPERATOR

- OSCILLATOR: MODE, DETUNE, COARSE, FINE
- ENVELOPE GENERATOR: EG (R1 ~ R4, L1 ~ L4), PITCH EG (R1 ~ R4, L1 ~ L4)
- KEYBOARD SCALING: LEVEL SCALING (LEFT DEPTH, LEFT CURVE, BREAK POINT, RIGHT CURVE, RIGHT DEPTH), RATE SCALING
- SENSITIVITY: KEY VELOCITY, AMPL. MODULATION
- OPERATOR OUTPUT LEVEL

### LFO

- WAVE, SPEED, DELAY, PMD, PMS, AMD, KEY SYNC

### OTHER

- OSCILLATOR KEY SYNC, TRANSPOSE, VOICE NAME

## Function Parameters

See FUNCTION JOB TABLE, page 15.

## Dimensions/Weight

- Dimensions: 1229W x 113H x 441Dmm (48.4" x 4.4" x 17.4")
- Weight: 18kg (39.7lbs)

## Power Requirements

U.S. & Canadian Models: 100 ~ 120V, 50/60Hz  
General Models: 100 ~ 120/200 ~ 240V, 50Hz



**Power Consumption**  
35W

**Supplied Accessories**

- MUSIC STAND
- POWER CABLE
- ROM VOICE MEMORY CARTRIDGE x 2
- ROM PERFORMANCE MEMORY CARTRIDGE x 1

\*Specifications subject to change without notice.

Function ...	Transmitted	Recognized	Remarks
Basic Default	: 1 - 16	: 1 - 16	: memorized
Channel Changed	: 1 - 16	: 1 - 16	
Mode Default	: 3	: 1,2,3,4	: memorized
Mode Messages	: OMNIon,OMNIoff POLY,MONO X2:	: OMNIon,OMNIoff POLY,MONO	: MONO M=1 only no altered
Note Number : True voice	: 28 - 103 XXXXXXXXXXXXXXXXXX	: 1 - 127 1 - 127	: ignore '0'
Velocity Note ON	: o 9nH,v=1-127X1:	: o v=1-127	
Velocity Note OFF	: x 9nH,v=0 X1:	: x	
After Key's	: x	: x	
Touch Ch's	: o	: X3: o	
Pitch Bender	: o	: X1: o 0 - 12 semi	: 7 bit resolution
Control Change	: 1 : o 2 : o 4 : o 5 : o 6 : o 7 : x  64 : o 65 : o 64 - 95 : o  96 : o 97 : o	: X2: o X2: o X2: o X2: o X2: o X2: o  X1: o X2: o X2: x  X2: o X2: o	: Modulation wheel : Breath control : Foot controller : Portamento time : Data entry knob : Volume  : Sustain foot sw : Portamento f sw : ON/OFF switch in : play mode : Data entry +1 : Data entry -1
Prog Change : True #	: o 0 - 63 XXXXXXXXXXXXXXXXXX	: X2: o 0 - 127 0 - 63	: Voice/ : Performance
System Exclusive	: o	: X4: o	: X4: Voice parameters
System : Song Pos	: x	: x	
System : Song Sel	: x	: x	
Common : Tune	: x	: x	
System : Clock	: x	: x	
Real Time : Commands	: o	: X1: x	
Aux : Local ON/OFF	: x	: x	
Aux : All Notes OFF	: x	: o (124-127)	
Mes- : Active Sense	: o	: o	
sages:Reset	: x	: x	
Notes: All MIDI communications are enabled if MIDI switch is on.			
X1 = transmit if BASIC EVENT switch is on.			
X2 = transmit if OTHER EVENT switch is on.			
X3 = transmit if OTHER EVENT sw and AFTER TOUCH sw are on.			
X4 = transmit/receive if SYSTEM EXCLUSIVE switch is on.			
Mode 1 : OMNI ON, POLY	Mode 2 : OMNI ON, MONO		o : Yes
Mode 3 : OMNI OFF, POLY	Mode 4 : OMNI OFF, MONO		x : No



SINCE 1887  **YAMAHA**  
NIPPON GAKKI CO., LTD. HAMAMATSU, JAPAN