

RY20

RHYTHM PROGRAMMER

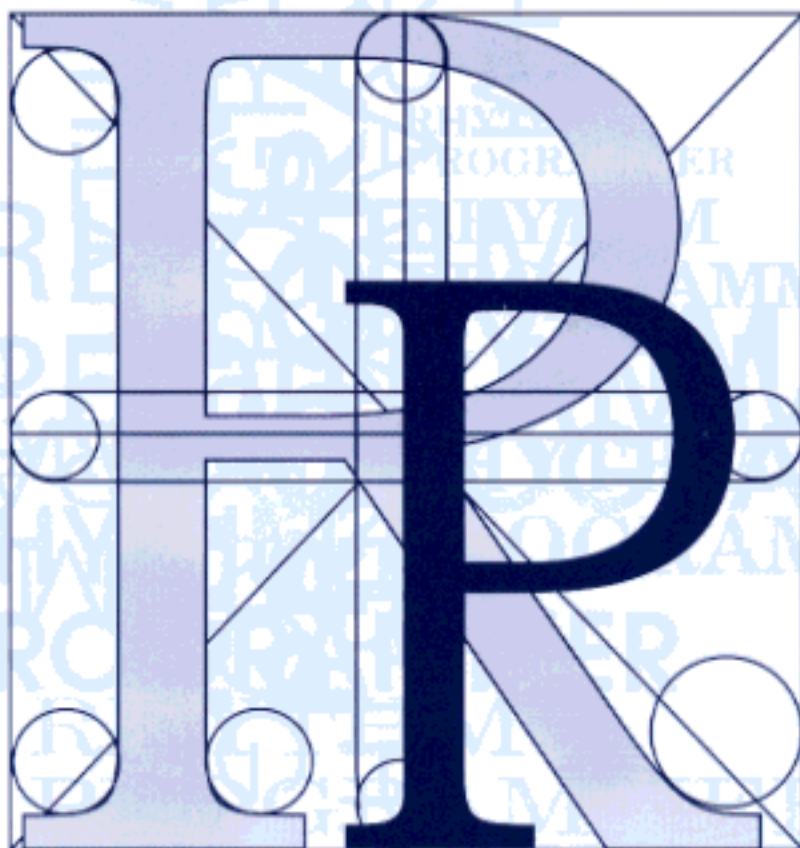

OWNER'S MANUAL

YAMAHA

SPECIAL MESSAGE SECTION

This product utilizes batteries or an external power supply (adapter). DO NOT connect this product to any power supply or adapter other than one described in the manual, on the name plate, or specifically recommended by Yamaha.

WARNING: Do not place this product in a position where anyone could walk on, trip over, or roll anything over power or connecting cords of any kind. The use of an extension cord is not recommended! If you must use an extension cord, the minimum wire size for a 25' cord (or less) is 18 AWG. NOTE: The smaller the AWG number, the larger the current handling capacity. For longer extension cords, consult a local electrician.

This Product should be used only with the components supplied or; a cart, rack, or stand that is recommended by Yamaha. If a cart, etc., is used, please observe all safety markings and instructions that accompany the accessory product.

SPECIFICATIONS SUBJECT TO CHANGE: The information contained in this manual is believed to be correct at the time of printing. However, Yamaha reserves the right to change or modify any of the specifications without notice or obligation to update existing units.

This product, either alone or in combination with an amplifier and headphones or speaker/s, may be capable of producing sound levels that could cause permanent hearing loss. DO NOT operate for long periods of time at a high volume level or at a level that is uncomfortable. If you experience any hearing loss or ringing in the ears, you should consult an audiologist. **IMPORTANT:** The louder the sound, the shorter the time period before damage occurs.

Some Yamaha products may have benches and/or accessory mounting fixtures that are either supplied with the product or as optional accessories. Some of these items are designed to be dealer assembled or installed. Please make sure that benches are stable and any optional fixtures (where applicable) are well secured BEFORE using. Benches supplied by Yamaha are designed for seating only. No other uses are recommended.

NOTICE: Service charges incurred due to lack of knowledge relating to how a function or effect works (when the unit is operating as designed) are not covered by the manufacturer's warranty, and are therefore the owners responsibility. Please study this manual carefully and consult your dealer before requesting service.

ENVIRONMENTAL ISSUES: Yamaha strives to produce products that are both user safe and environmentally friendly. We sincerely believe that our products and the production methods used to produce them, meet these goals. In keeping with both the letter and the spirit of the law, we want you to be aware of the following:

Battery Notice: This product MAY contain a small non-rechargeable battery which (if applicable) is soldered in place. The average life span of this type of battery is approximately five years. When replacement becomes necessary, contact a qualified service representative to perform the replacement.

This Product may also use "household" type batteries. Some of these may be rechargeable. Make sure that the battery being charged is a rechargeable type and that the charger is intended for the battery being charged.

When installing batteries, do not mix old batteries with new, or with batteries of a different type. Batteries MUST be installed correctly. Mismatches or incorrect installation may result in overheating and battery case rupture.

Warning: Do not attempt to disassemble, or incinerate any battery. Keep all batteries away from children. Dispose of used batteries promptly and as regulated by the laws in your area.

Note: Check with any retailer of household type batteries in your area for battery disposal information.

Disposal Notice: Should this Product become damaged beyond repair, or for some reason its useful life is considered to be at an end, please observe all local, state, and federal regulations that relate to the disposal of products that contain lead, batteries, plastics, etc. If your dealer is unable to assist you, Please contact Yamaha directly.

NAME PLATE LOCATION: The name Plate is located on the bottom of the product. The model number, serial number, power requirements, etc., are located on this plate. You should record the model number, serial number, and the date of purchase in the spaces provided below and retain this manual as a permanent record of your purchase.

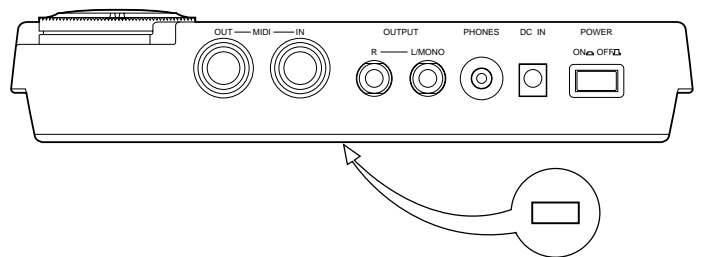

Model _____

Serial No. _____

Purchase Date _____

PLEASE KEEP THIS MANUAL

FCC INFORMATION (U.S.A.)

1. IMPORTANT NOTICE: DO NOT MODIFY THIS UNIT!

This product, when installed as indicated in the instructions contained in this manual, meets FCC requirements. Modifications not expressly approved by Yamaha may void your authority, granted by the FCC, to use the product.

2. **IMPORTANT:** When connecting this product to accessories and/or another product use only high quality shielded cables. Cable/s supplied with this product **MUST** be used. Follow all installation instructions. Failure to follow instructions could void your FCC authorization to use this product in the USA.

3. **NOTE:** This product has been tested and found to comply with the requirements listed in FCC Regulations, Part 15 for Class "B" digital devices. Compliance with these requirements provides a reasonable level of assurance that your use of this product in a residential environment will not result in harmful interference with other electronic devices. This equipment generates/uses radio frequencies and, if not installed and used according to the instructions found in the users manual, may cause interference harmful to the operation of other electronic devices. Compliance with FCC regulations does not guarantee that interference will not occur in all installations. If this product is found to be the source of interference, which can be determined by turning the unit "OFF" and "ON", please try to eliminate the problem by using one of the following measures:

Relocate either this product or the device that is being affected by the interference

Utilize power outlets that are on different branch (circuit breaker or fuse) circuits or install AC line filter/s.

In the case of radio or TV interference, relocate/reorient the antenna. If the antenna lead-in is 300 ohm ribbon lead, change the lead-in to co-axial type cable.

If these corrective measures do not produce satisfactory results, please contact the local retailer authorized to distribute this type of product. If you can not locate the appropriate retailer, please contact Yamaha Corporation of America, Electronic Service Division, 6600 Orangethorpe Ave, Buena Park, CA 90620

*This applies only to products distributed by YAMAHA CORPORATION OF AMERICA

CANADA

THIS DIGITAL APPARATUS DOES NOT EXCEED THE "CLASS B" LIMITS FOR RADIO NOISE EMISSIONS FROM DIGITAL APPARATUS SET OUT IN THE RADIO INTERFERING REGULATION OF THE CANADIAN DEPARTMENT OF COMMUNICATIONS.

LE PRESENT APPAREIL NUMERIQUE N'EMET PAS DE BRUITS RADIOELECTRIQUES DEPASSANT LES LIMITES APPLICABLES AUX APPAREILS NUMERIQUES DE LA "CLASSE B" PRESCRITES DANS LE REGLEMENT SUR LE BROUILLAGE RADIOELECTRIQUE EDICTE PAR LE MINISTERE DES COMMUNICATIONS DU CANADA.

* This applies only to products distributed by YAMAHA CANADA MUSIC LTD.

ADVARSEL!

Lithiumbatteri—Eksplosionsfare ved fejlagtig håndtering. Udskiftning må kun ske med batteri af samme fabrikat og type. Levér det brugte batteri tilbage til leverandoren.

VARNING

Explosionsfara vid felaktigt batteribyte. Använd samma batterityp eller en ekvivalent typ som rekommenderas av apparattillverkaren. Kassera använt batteri enligt fabrikantens instruktion.

VAROITUS

Paristo voi räjähtää, jos se on virheellisesti asennettu. Vaihda paristo ainoastaan laitevalmistajan suosittelemaan tyyppiin. Hävitä käytetty paristo valmistajan ohjeiden mukaisesti.

Bescheinigung des Importeurs

Hiermit wird bescheinigt, daß der/die/das

Gerät: Rhythm Programmer Typ : RY20

(Gerät, Typ, Bezeichnung)

in Übereinstimmung mit den Bestimmungen der

VERFÜGUNG 1046/84

(Amtsblattverfügung)

funkentstört ist.

Der Deutschen Bundespost wurde das Inverkehrbringen dieses Gerätes angezeigt und die Berechtigung zur Überprüfung der Serie auf Einhaltung der Bestimmungen eingeräumt.

Yamaha Europa GmbH

Name des Importeurs

Dette apparat overholder det gældende EF-direktiv vedrørende radiostøj.

Cet appareil est conforme aux prescriptions de la directive communautaire 87/308/CEE.

Diese Geräte entsprechen der EG-Richtlinie 82/499/EWG und/oder 87/308/EWG.

This product complies with the radio frequency interference requirements of the Council Directive 82/499/EEC and/or 87/308/EEC.

Questo apparecchio è conforme al D.M.13 aprile 1989 (Direttiva CEE/87/308) sulla soppressione dei radiodisturbi.

Este producto está de acuerdo con los requisitos sobre interferencias de radio frecuencia fijados por el Consejo Directivo 87/308/CEE.

YAMAHA CORPORATION

* Dies bezieht sich nur auf die von der Yamaha Europa GmbH vertriebenen Produkte.



Precautions

Your RY20 will give you years of reliable service if you follow the simple rules given below:

■ Location

Do not expose the instrument to the following conditions, to avoid deformation, discoloration, or more serious damage.

- Direct sunlight, such as near a window.
- High temperatures, for example, near a heat source, outdoors, or in a car during the daytime.
- Excessive humidity.
- Excessive dust.
- Strong vibrations.

■ Power Supply

Always use the supplied Yamaha AC Adaptor to power your RY20. Other adaptors may cause damage to the RY20. Also, make sure that the adaptor you have is appropriate for the AC mains supply voltage in the area where you intend to use the RY20.

NOTE

The correct INPUT voltage is marked on the top of the adaptor.

Turn the power OFF and unplug the AC adaptor when the instrument is not in use.

Unplug the AC adaptor during electrical storms.

Avoid plugging the AC adaptor used with the RY20 into the same AC mains outlet as appliances with high power consumption, such as electric heaters or ovens. Also avoid using multi-plug adaptors since these can result in reduced sound quality and possibly damage.

Turn off the power before making or breaking connections.

To avoid damage to the instrument and other devices to which it is connected (a sound system, for example), always turn the power switches of all related devices OFF before connecting or disconnecting audio and MIDI cables.

■ Handling and Transport

Never apply excessive force to the controls, connectors, or other parts of the instrument.

Always plug and unplug any cables by gripping the connector, **not** the cord itself. Disconnect all cables before moving the instrument.

Dropping the RY20 or otherwise subjecting it to strong physical shocks can damage it. Handle it with care.

■ **Cleaning**

Clean the cabinet and panel with a soft dry cloth. A slightly damp cloth may be used to remove stubborn grime and dirt.

Do not use solvents such as alcohol, benzene, or thinner to clean the cabinet or panel.

Avoid placing vinyl objects on top of the instrument. Vinyl can stick to and discolor the surface.

■ **Electrical Interference**

The RY20 contains digital circuitry and may cause interference or noise if placed too close to TV sets, radios, or similar equipment. If such a problem does occur, move the RY20 further away from the affected equipment.

■ **Memory Back-up**

The RY20 contains a special long-life battery that retains the contents of its internal RAM memory even when the power is turned OFF. The back-up battery should last for several years. When the back-up battery needs to be replaced, the message "BATT LOW" will momentarily appear on the display when you turn the power ON. When this happens, have the back-up battery replaced by qualified Yamaha service personnel.

WARNING

DO NOT ATTEMPT TO REPLACE THE BACK-UP BATTERY YOURSELF.

Transfer important data from your RY20 to a MIDI data recorder such as the Yamaha MDF2 MIDI Data Filer for safe long-term storage. Yamaha cannot be held responsible for data loss caused by battery failure or improper operation of the RY20.

■ **Service and Modification**

The RY20 contains no user-serviceable parts. Opening the case and/or tampering with the internal circuitry can lead to irreparable damage and will void the warranty. Refer all maintenance to qualified Yamaha service personnel.

■ **Third-party Software**

Yamaha cannot take any responsibility for software produced for this product by third-party manufacturers. Please direct any comments about such software to the manufacturer or their agents.

YAMAHA is not responsible for damage caused by improper handling or operation.



Introduction

With its wide collection of voices and easy-to-use controls, the Yamaha RY20 is the perfect musical partner for guitarists, bassists, keyboard players, and many other instrumentalists. It offers the features and capability required for recording applications, rehearsals and practice sessions, and live performance.

The RY20 uses Yamaha's AWM (Advanced Wave Memory) tone generator system to create 300 realistic tunable voices including drums, effected drums, percussion of all kinds, and basses. You can add effects to the voices, either reverb or delay, using the built-in DSP (Digital Signal Processor). Using one of the 20 user drum kits, you can assign any voice to one of the pads.

The RY20 has 50 professionally-programmed preset patterns. You can also create and store 50 user patterns of your own, and combine tracks from different patterns and store them for an additional 50 "combination" patterns. Each pattern has six sections ("INTRO", "MAIN A", "MAIN B", "FILL AB", "FILL BA", and "ENDING") and each section has four tracks (bass drum, snare drum, hi-hat and other instruments).

Patterns can be combined to create complete songs. The RY20 can store 50 songs in its user song memory.

It features easy-to-use controls with a large, useful LCD display. Change values quickly using the Shuttle dial, then fine-tune them using the Jog dial. Create patterns in real-time or step record mode using the velocity-sensitive pads. Make up "kits" of commonly-used drum and bass sounds. Make your patterns reflect your musical ideas and escape from the "mechanical feel" common to conventional rhythm machines by using the built-in swing and groove functions.

The RY20 includes full MIDI capabilities (including General MIDI compatible drum mapping) to allow full communication with the rest of your MIDI set-up.

Please read this owner's manual carefully in order to familiarize yourself with the RY20 and its features – and keep the manual in a safe place for later reference.

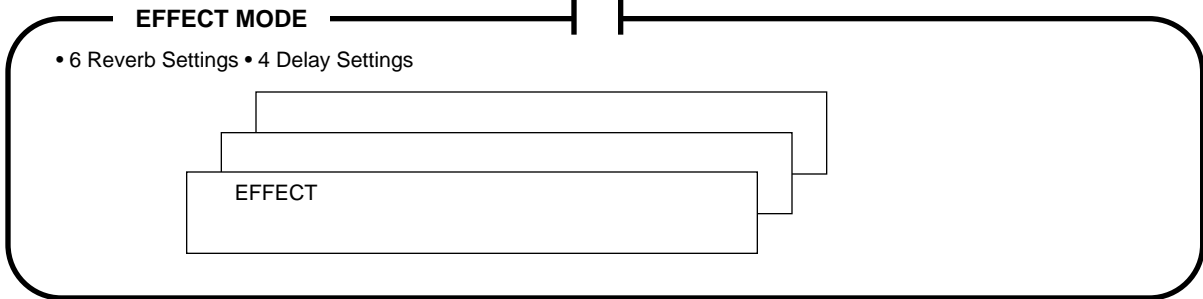
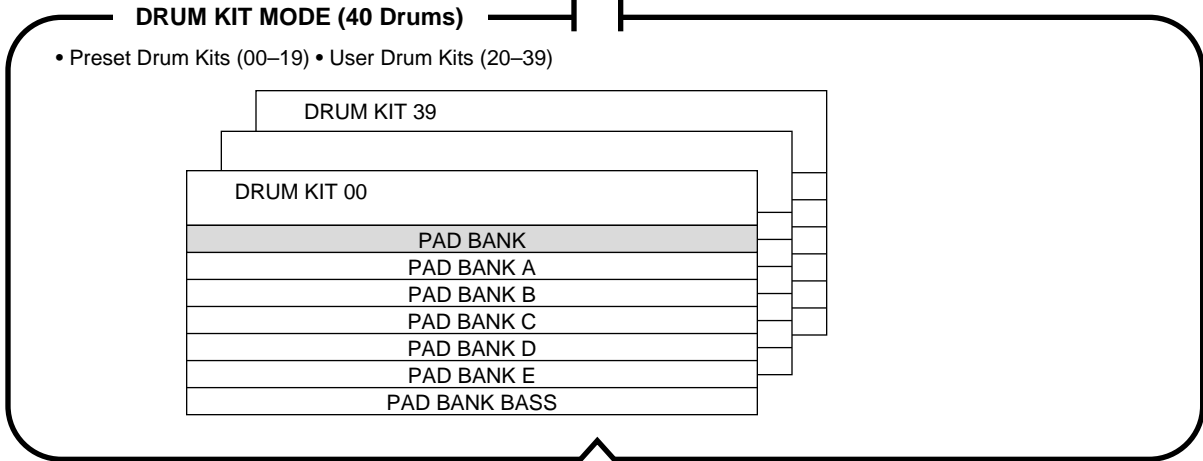
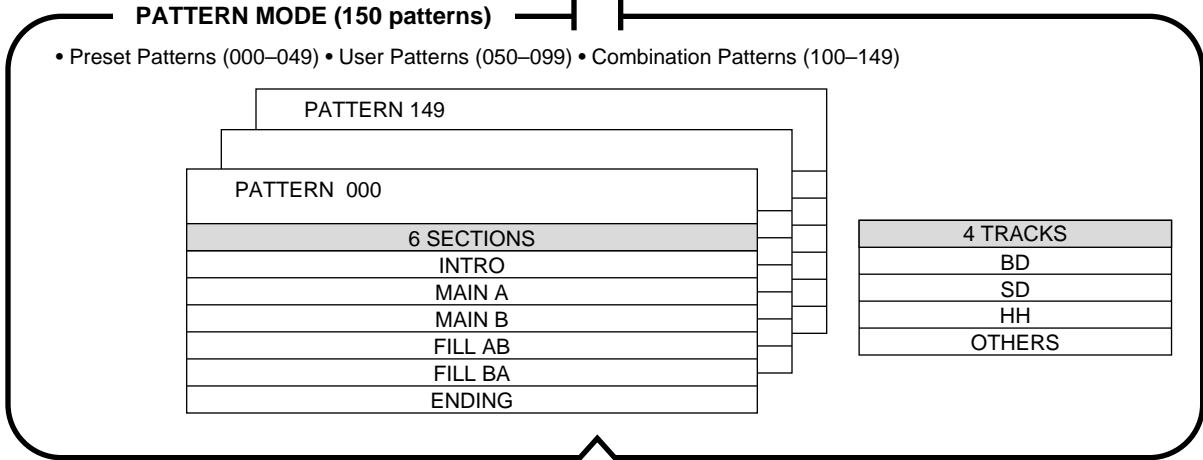

Contents

1	The Controls and Connections	2	Copying a Song.....	79	
	Front Panel.....	2	Name that Song.....	81	
	Rear Panel.....	8	9	Modifying the Drum Kits	82
	Making Connections.....	9		Assigning Voices to Each Pad.....	83
	Turn on the RY20.....	11		Volume Level.....	86
2	Playing the Demo Song	12		Stereo Pan.....	87
3	Playing the Preset Patterns	14		Pitch.....	88
	Changing Pattern Numbers During			Decay.....	89
	Playback.....	16		Sensitivities.....	90
	Selecting the Sections.....	16		Voice Polyphony.....	95
	Setting the Tempo.....	19		Alternate Group.....	96
	Muting a Track.....	20		Note/Trigger Driven.....	97
4	Playing the Pads	21		Pad Sensitivity.....	98
	Selecting a Drum Kit.....	22		Chase.....	99
	Selecting a Pad Bank.....	23		Copy.....	100
	Playing the Bass Voices.....	24		Name.....	101
5	Recording a User Pattern	28	10	Changing the Effects	102
	Recording Modes.....	28		Enabling Effects.....	102
	Step Record Mode.....	29		Select the Effect Type.....	103
	Real-time Record Mode.....	35		Send Level.....	104
	Combination Patterns.....	38		Return Level.....	105
	Editing Patterns.....	39		Reverb Time.....	106
	Quantization.....	44		Feedback Gain.....	107
	Gate Time.....	45		Delay Time.....	108
	Changing the Meter.....	46	11	MIDI Functions	110
	Adjusting the Click.....	47		MIDI Sync.....	110
6	Other Pattern Functions	49		Drum Instruments MIDI Channel.....	111
	Swing.....	49		Bass Instrument MIDI Channel.....	112
	Groove.....	50		Program Change MIDI Channel.....	113
	Velocity Modify.....	54		MIDI Note Assignment.....	114
	Clearing a Pattern.....	55		Volume and Expression.....	116
	Copying a Pattern.....	57		Bulk Dump.....	118
	Setting the Pattern Name.....	60		Receiving Bulk Data.....	118
7	Recording a Song	62	Appendix	120	
	Step Record Mode.....	62		Total Reset Procedure.....	120
	Real-Time Record Mode.....	67		Pattern List.....	121
	Setting the Tempo.....	69		Drum Kit List.....	122
	Deleting a Part.....	69		Voice List.....	124
	Inserting a Part.....	70		Troubleshooting.....	126
	Adjusting the Click.....	72		LCD Messages.....	127
8	Playing the Songs	73		Specifications.....	128
	Playing a Song.....	73		MIDI Data Format.....	129
	Chain and Repeat.....	75		MIDI Implementation Chart.....	130
	Clearing a Song.....	77	Index	131	

1

The Controls and Connections

■ Front Panel

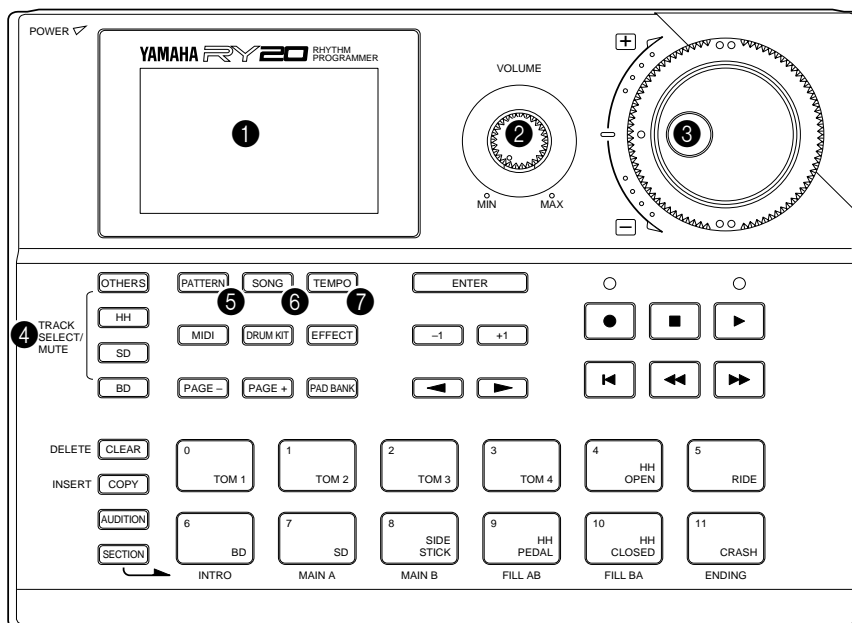

1 LCD Panel

This large multi-function LCD panel shows all the prompts and parameters needed to operate the RY20 with ease and efficiency.

Each screen full of information is known as a display “page.” The various display pages in each mode are accessed using the **PAGE-** and **PAGE+** buttons described below.

Within a display page, there are various “focus” areas. A focus area is a parameter you can adjust, identified by a flashing prompt. Use the **◀** and **▶** cursor buttons to change the focus area.

2 Volume Control

The volume control adjusts the volume of sound output from the rear-panel PHONES jack or the OUTPUT (R and L/MONO) jacks.

CAUTION

Set the volume control to MIN when connecting the RY20 to a sound system or headphone for the first time. Gradually raise the volume level until a comfortable listening level is reached.

This simple precaution can prevent unexpectedly high volume levels from damaging your sound system, headphones, or most important, your ears.

3 Jog and Shuttle Dials

The Jog and Shuttle Dials allow rapid control over the various features of the RY20.

The Jog Dial is a continuously rotating control. By rotating it you can quickly change the current value. You use it to select patterns or songs, to change the tempo, or to modify any of a number of other parameters.

The Shuttle Dial is a center detented, spring-loaded control. It allows you even more rapid access to the current value. The further you rotate the Shuttle Dial from its center detent, the faster the parameter will scroll.

For fine single-step adjustments, you may want to use the **+1** and **-1** buttons, described below.

4 Track Select/Mute Buttons

These buttons allow you to mute tracks. The buttons are **OTHERS**, **HH**, **SD**, and **BD**. When you press one of these buttons, the corresponding mute indicator lights up next to the track name on the LCD.

When you are copying or clearing pattern data from the RY20, these buttons allow you to select the track or tracks you wish to copy or clear.

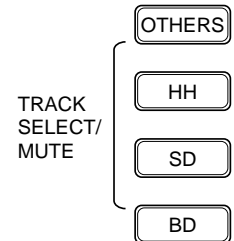
**5 Pattern Button**

The **PATTERN** button switches the RY20 to Pattern Mode. In this mode you can select a pattern to play, record, or modify.

**6 Song Button**

The **SONG** button switches the RY20 to Song Mode. This mode allows you to select a song which you can then play, record, or modify.

**7 Tempo Button**

The **TEMPO** button switches to the tempo function. You can change the tempo with the Jog dial or the **+1** and **-1** buttons.



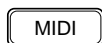
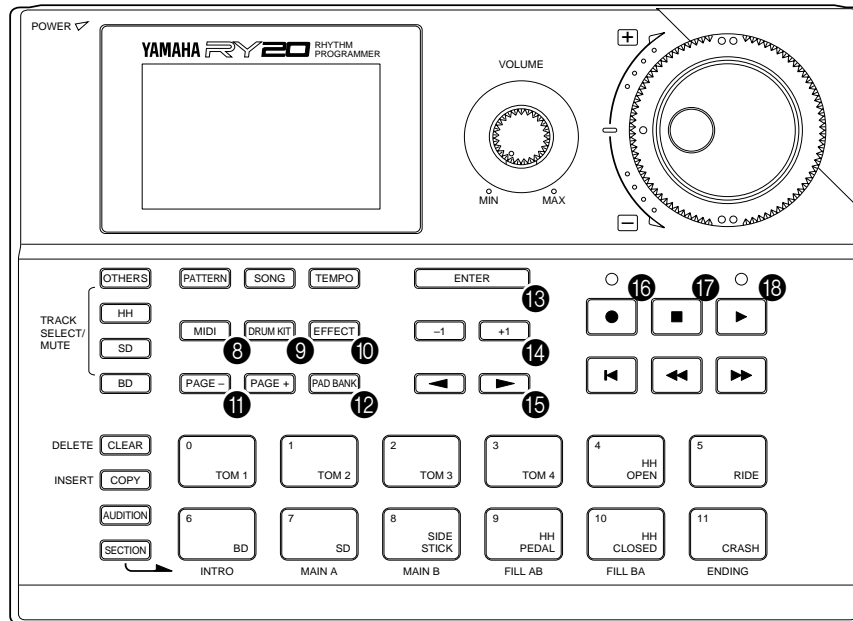

8 MIDI Button

The **MIDI** button switches the RY20 to MIDI Mode. In this mode you can set or modify the MIDI control functions.

The RY20 can both receive and transmit MIDI data.



9 Drum Kit Button

The **DRUM KIT** button switches the RY20 to Drum Kit Mode. In this mode you can select another drum kit or modify the parameters of the current drum kit.



10 Effect Button

The **EFFECT** button switches the RY20 to Effect Mode. In this mode you can change the current effect or modify the effect parameters.



11 Page+ and Page- Buttons

The **PAGE+** and **PAGE-** buttons select the display pages within the various modes.



12 Pad Bank Button

The **PAD BANK** button is used to select “DRUM” or “BASS” mode. In drum mode, it is used to select one of the five banks in each drum kit. In bass mode, it is used to select one of the five octaves of the bass bank.

13 Enter Button

The **ENTER** button is used to confirm special operations that will change data in the internal memory, for example, clearing a pattern or song.

**14 +1 and -1 Buttons**

The **+1** (increment) and **-1** (decrement) buttons are used along with the Jog Dial or the Shuttle Dial to select patterns or songs, to change tempo values, or to modify other parameters.



Use these buttons when you require a fine degree of control rather than the speed and convenience of the Jog Dial or the Shuttle Dial.

15 Cursor Buttons

The **◀** and **▶** cursor buttons change the focus within a display page, selecting the various parameters that are available for editing.

**NOTE**

The focus is always indicated by the flashing prompt or symbol.

16 Record Button and Record LED

The **RECORD** button switches the RY20 into Record Mode in either Pattern Mode or Song Mode. The red Record LED lights up and the Rhythm Programmer is ready for you to begin creating.

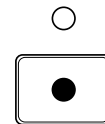
**NOTE**

*The default Record Mode for either a pattern or a song is Step Record Mode. Press the **PLAY** button for Real-time Record Mode.*

Press the **RECORD** button again to cancel Record Mode. The red Record LED switches off and the RY20 returns to either Pattern Mode or Song Mode.

17 Stop Button

The **STOP** button stops playback or turns off Real-time Record Mode.

**18 Play Button and Play LED**

The **PLAY** button starts playback of a pattern or song. You also use it to begin real-time recording of a pattern or song.

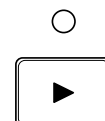

The green Play LED will flash in time with the current tempo setting.

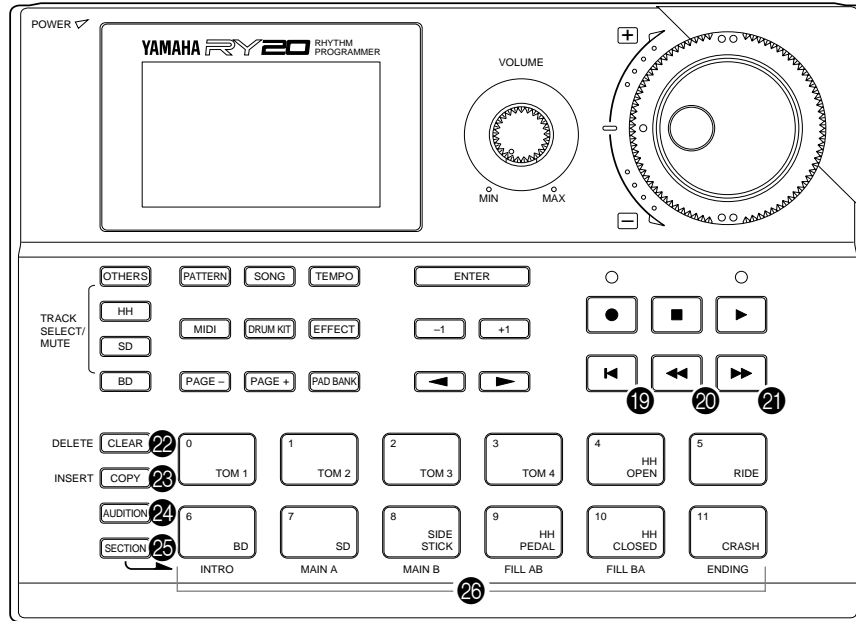

19 Top Button

The **TOP** button resets the current position to the beginning of the pattern or song. This button performs the same function in Record Mode.



20 Backward Button

The **BACKWARD** button steps backwards through a song or pattern.



21 Forward Button

The **FORWARD** button steps forwards through a song or pattern.



22 Clear/Delete Button

The **CLEAR** button is used to clear all the data in the selected pattern or song in Pattern or Song Mode. In Record Mode, it is used to delete individual parts, such as an incorrect or unwanted note in a pattern, or an unwanted part in a song.



23 Copy/Insert Button

The **COPY** button is used to copy the current song or pattern to another location. In Song Record Mode, it is used to insert new data into a song.

24 Audition Button



The **AUDITION** button allows you to listen to a voice without actually recording it when the RY20 is in Pattern Record Mode.

25 Section Button



The **SECTION** button is used with one of the lower row Drum Pads to select another section in a pattern.

26 Drum Pads

The RY20 has 12 velocity-sensitive drum pads that you play to record pattern data.

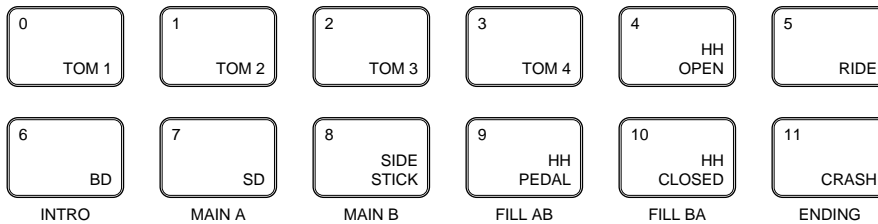

NOTE

*The voices of the RY20 are fully programmable and can be assigned to any pad. The drum pads are labeled **0** through **11** and also have a drum name printed on them. The voice assigned to the pad may not correspond to the name printed on the pad. See page 83 for further details.*

The lower row Drum Pads are used to select the pattern sections. Each pad has a section label printed below it.

■ Rear Panel

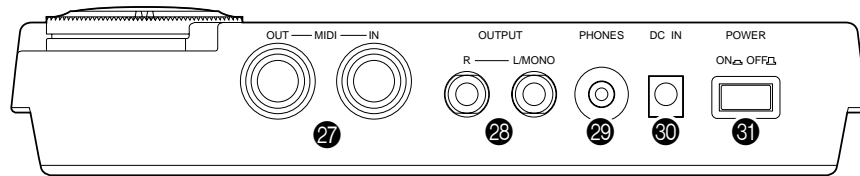

27 MIDI IN and OUT Connectors

The MIDI IN connector receives data from a sequencer or other MIDI device used to control the RY20.

The MIDI OUT connector transmits MIDI data to other MIDI devices. The RY20 can control other instruments with note and timing messages. It also uses MIDI to transmit the contents of its internal memory. See page 110 for further details.

28 OUTPUT L/MONO and R Jacks

These phone jacks are the main stereo outputs from the RY20. If a plug is inserted into the L/MONO jack only, the left and right-channel signals are combined and delivered via this jack (which can be used for connecting to a mono sound system).

The Volume control adjusts the level of the signal sent to these jacks.

29 PHONES Jack

Accepts a pair of stereo headphones with a miniature stereo phone plug for headphone monitoring of the RY20.

30 DC IN Jack

The DC output cable from the supplied AC Adaptor should be connected here.

CAUTION

Always use the supplied Yamaha AC Adaptor to power your RY20. The use of an incompatible adaptor may cause irreparable damage to the RY20, and might pose a serious shock hazard.

31 Power Switch

Press this switch to turn the RY20 power ON or OFF.

■ Making Connections

Using the Supplied Power Adaptor

When connecting the power supply, make sure the RY20 Power switch is in the OFF position (extended), then plug the AC Adaptor cable into the DC IN Jack, and finally the adaptor's AC plug into a convenient AC mains outlet.

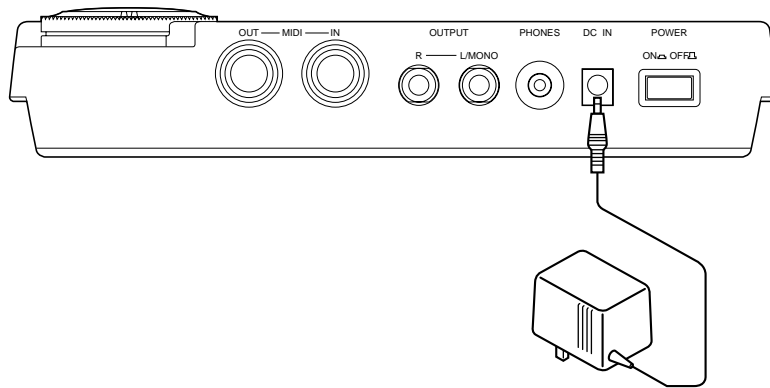

Audio Connections

The simplest way to monitor your RY20 is through a set of stereo headphones (miniature stereo phone plug type). Connect them to the PHONES jack on the rear panel of the instrument.

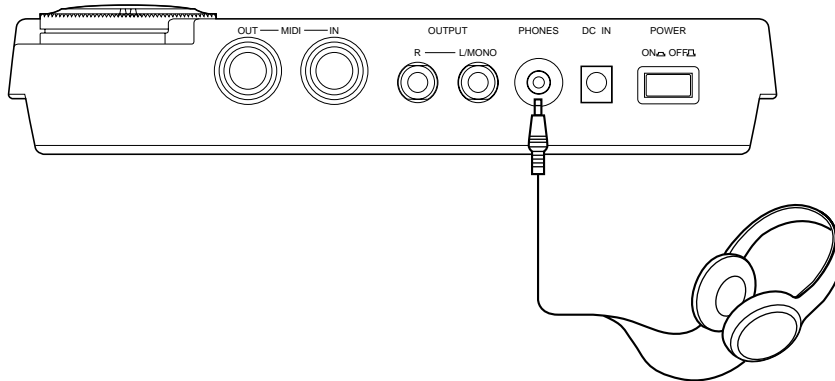

CAUTION

It is possible to produce sounds with the RY20 that are loud enough to cause hearing damage. Set the volume control to MIN when connecting the RY20 to headphones for the first time. Gradually raise the volume level until a comfortable listening level is reached.

Use the OUTPUT L/MONO and R jacks to connect the audio outputs of the RY20 to an external stereo sound system, as shown below.

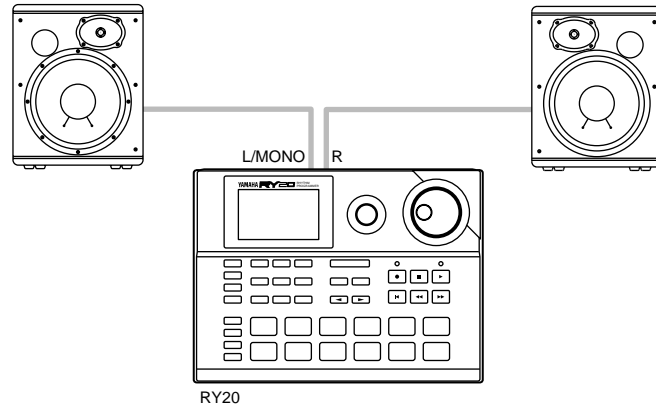

If your sound system is monophonic, connect only the L/MONO jack.

CAUTION

Make sure that both the RY20 and your sound system are turned OFF when making connections. Failure to do so may result in damage to the sound system.

MIDI Connections

If you intend to use other MIDI instruments with your RY20, you must connect them properly.

The following diagram shows a simple connection.

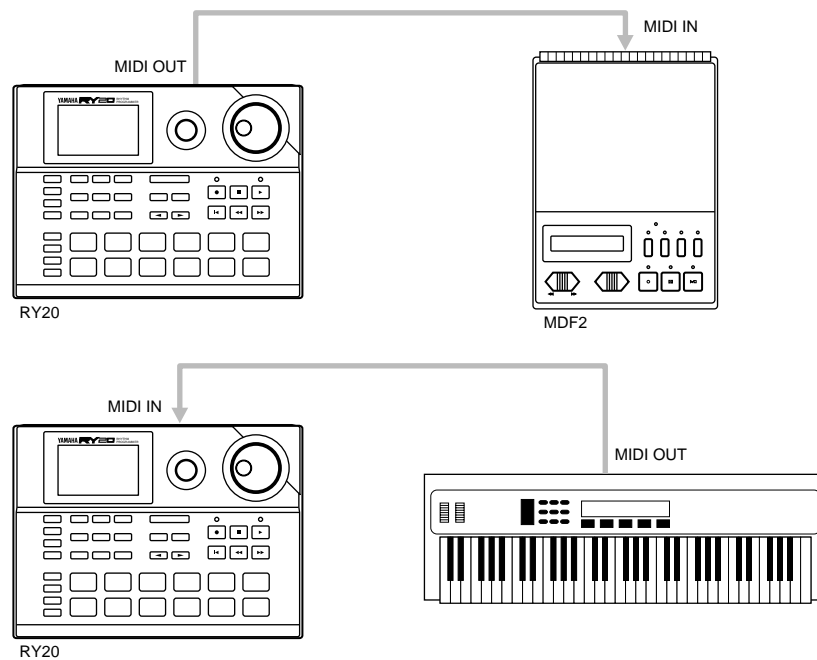

For further details on MIDI and MIDI connections, see page 110.

■ Turn on the RY20

To turn on the RY20, first make all the required connections. When connecting the power supply, make sure the RY20 Power switch is in the OFF position (extended), then plug the AC Adaptor cable into the DC IN Jack, and finally the adaptor's AC plug into a convenient AC mains outlet.

CAUTION

Always use the Yamaha PA-3 AC Adaptor to power your RY20. The use of an incompatible adaptor may cause irreparable damage to the RY20, and might pose a serious shock hazard.

Be sure to unplug the AC Adaptor from the AC mains outlet when the RY20 is not in use.

Once you have completed the connections, turn the RY20 on by pressing in the Power switch. The following display will momentarily appear:

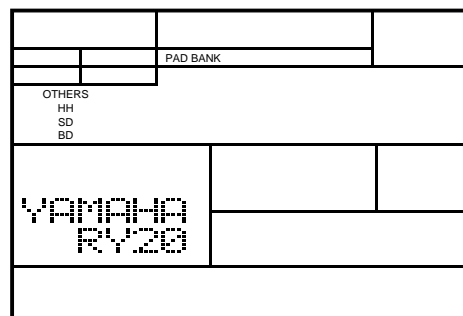

The RY20 will then switch to Pattern Mode.

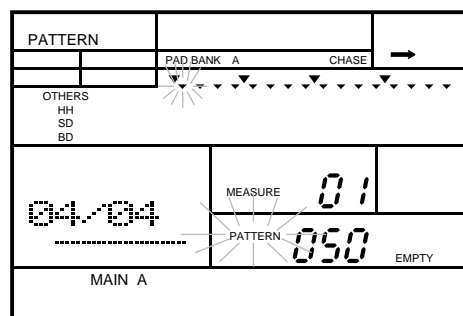

See page 14 for details of the RY20 patterns and instructions for playing the preset patterns.

NOTE

The pattern numbers "050" through "149" are user and combination patterns, and currently have no data. For information about recording and playing these patterns, read the information starting on page 28.

2

Playing the Demo Song

The RY20 is programmed with a demonstration song that will give you an example of the various capabilities of your Rhythm Programmer.

SONG

- 1 Press the **SONG** button to place the unit in Song Mode. Notice that the “SONG” indicator is flashing above the current Song Number.

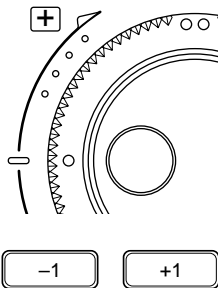
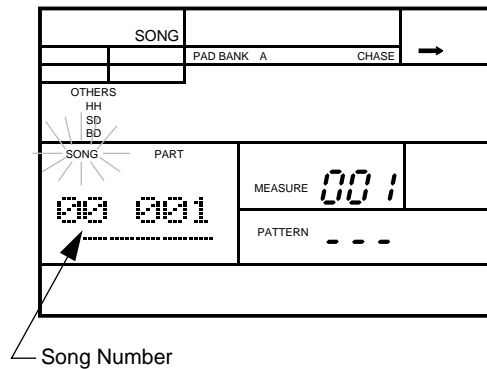

- 2 Select the demonstration song by rotating the Jog Dial or by using the **+1** and **-1** buttons.

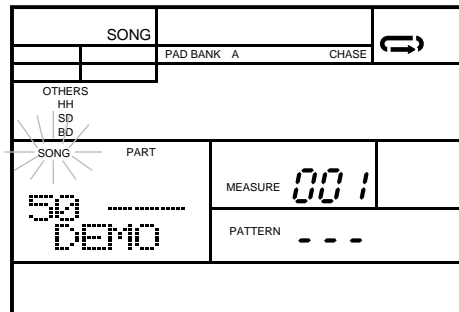

The demonstration song is number 50 - “DEMO”.

HINT

A quick way to select an item at either end of a range of settings is to use the Shuttle Dial.

For example, to select the demonstration song, rotate the Shuttle Dial clockwise. The Shuttle Dial increases the song number much more rapidly than the **+1** button or even the Jog Dial.

- 3** Press the **PLAY** button to start the demonstration song. The green Play LED will flash in time with the programmed tempo setting and the song will begin playback.

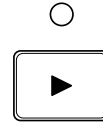

NOTE

As the song plays, the Voice Level Indicator for the active drum pad lights up on the LCD. The display behaviour is similar to that of a VU meter.

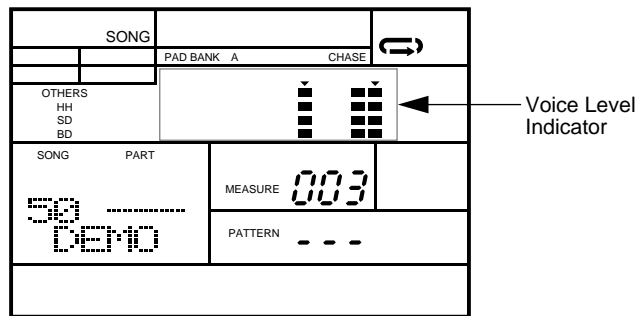

Adjust the volume of the playback by rotating the VOLUME control.

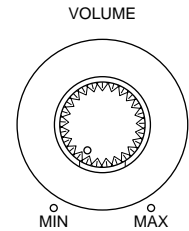

NOTE

You cannot adjust the tempo of the demonstration song. You also cannot copy, clear, or edit the demonstration song.

- 4** Press the **STOP** button to stop the demonstration song. The green Play LED stops flashing.



NOTE

The demonstration song sets the Repeat function. For further details see page 75.

The demonstration song repeats until you stop the RY20 by pressing the **STOP** button.

- 5** Press the **PLAY** button again to start the song from the point at which it was stopped.

3 Playing the Preset Patterns

The RY20 is programmed with 50 preset patterns covering a wide variety of musical styles which you can use to construct combination patterns or songs.



- 1 Press the **PATTERN** button to place the unit in Pattern Mode. Notice that the “PATTERN” indicator is flashing beside the current Pattern Number.

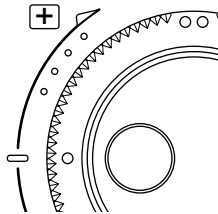
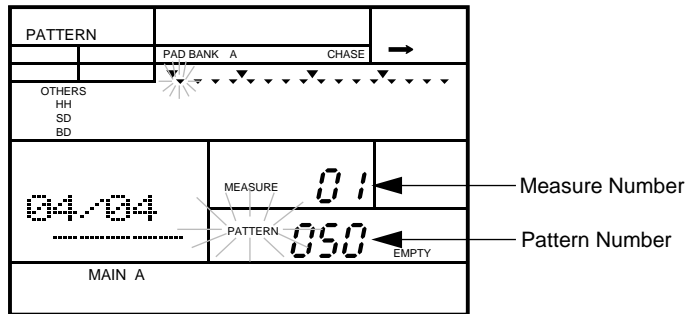

- 2 Select a pattern by rotating the Jog Dial or by using the **+1** and **-1** buttons.

The preset patterns are from number “000” to number “049”. Refer to the list of preset patterns provided on page 121.

NOTE

The RY20 is shipped with no data recorded in patterns “050” to “149”.

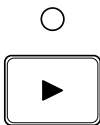

- 3 Press the **PLAY** button to start the pattern. The green Play LED will flash in time with the current tempo setting and the pattern will begin playback.

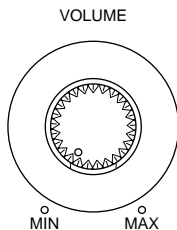

- 4 Adjust the volume of the playback by rotating the VOLUME control.

As the pattern plays, the Voice Level Indicator for the active drum pad lights up on the LCD.

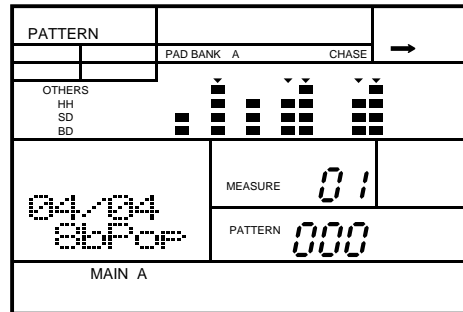

Voice Level Indicators

Each drum pad is associated with a Voice Level Indicator. As each voice sounds, the Voice Level Indicator lights up depending on how loud the voice was recorded.

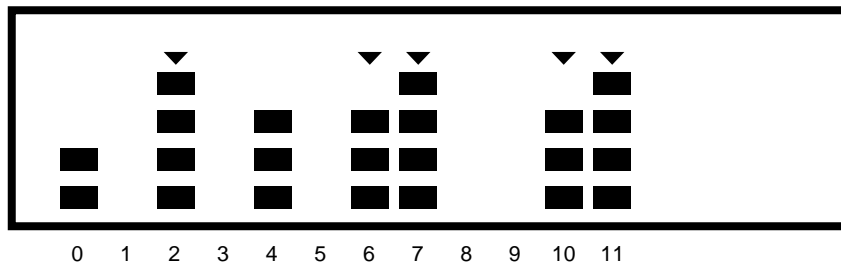

0 TOM 1	1 TOM 2	2 TOM 3	3 TOM 4	4 HH OPEN	5 RIDE
6 BD INTRO	7 SD MAIN A	8 SIDE STICK MAIN B	9 HH PEDAL FILL AB	10 HH CLOSED FILL BA	11 CRASH ENDING

5 Press the **STOP** button to stop playing the pattern. The green Play LED stops flashing.



6 Press the **PLAY** button again to start the pattern from the point at which it was stopped.

NOTE

If you want to play the pattern from the beginning again, press the **TOP** button to reset the position. Then press the **PLAY** button to play the pattern again.



■ Changing Pattern Numbers During Playback

A new pattern can be selected while another pattern is already playing on the RY20.

Select the next pattern by rotating the Jog Dial or by using the **+1** and **-1** buttons.

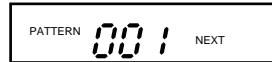

The “NEXT” indicator lights up until the current pattern has finished. The name then changes on the display and the new pattern starts to play.

If the pattern you have selected is empty, the “EMPTY” indicator will also light up.

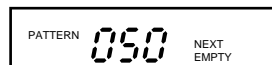

■ Selecting the Sections

A pattern on the RY20 consists of six sections. Each section can be programmed for a specific purpose. The preset patterns have all six sections programmed.

The sections are:

- **INTRO** - This section is used for the introduction to the pattern. When it has finished playing the introduction, the RY20 automatically switches to the “MAIN A” section.
- **MAIN A** - This is the default section. It can be used for the basic verse and chorus structure of a pattern.
- **MAIN B** - This the alternative section. It can be used for the bridge structure of a pattern.

There are two transition sections, both play immediately when selected:

- **FILL AB** - This section is used to make the transition between the verse/chorus section and the bridge section. When it is complete, the unit starts to play section “MAIN B”.

- **FILL BA** - This section is used to make the transition back to the verse/chorus section from the bridge section. When it has completed playing, it switches to “MAIN A”.

There is also a finale section:

- **ENDING** - As its name implies, this section ends the pattern play when it is complete.

NOTE

When the “ENDING” section has completed, it stops the playback and sets the RY20 back to “MAIN A” to prepare for playing the next pattern.

You can select a section before you start playing a pattern. For example, select the “INTRO” section of the pattern. After you have started the pattern playing, you can select other sections.

NOTE

When you select a section other than the two transition sections, the newly selected section will begin playing after the current section has finished playing.

- 1 Press and hold the **SECTION** button, then press the Drum Pad button for the section you want to play. The appropriate Section indicator lights up, for example, the “INTRO” indicator.

There are labels below the lower row of drum pads indicating the different sections.

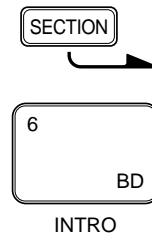
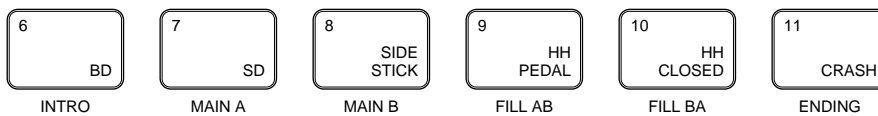

- 2 Start playing the pattern by pressing the **PLAY** button. The green Play LED will flash to the current tempo setting and the pattern will begin playback.

The “INTRO” section plays, automatically followed by the “MAIN A” section.

- 3 Select another section. For example, select the “MAIN B” section. Press and hold the **SECTION** button. Then press the **8 - SIDE STICK** drum pad button, which corresponds to the “MAIN B” section.

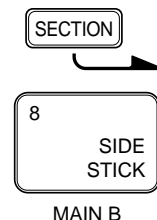

The “MAIN B” section indicator and the “NEXT” indicator both light.

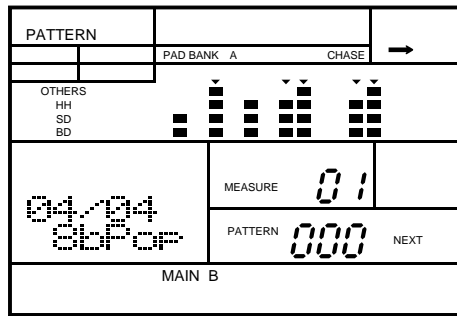

If the section is empty, the “EMPTY” indicator will also light up.

Selecting a Measure

Each section consists of one or more measures.

While the RY20 is stopped, you can select one of the measures of the current pattern.



The **FORWARD** button steps forwards through the measures of the pattern. Each time you press the button, the RY20 moves to the next measure.

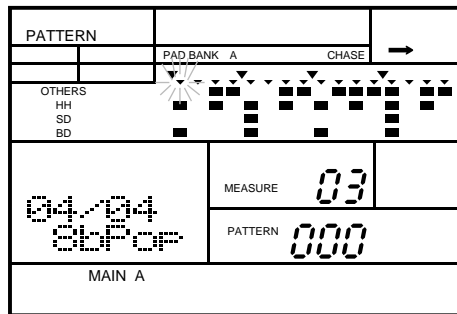

Press the **PLAY** button to start playback at the selected measure.



The **BACKWARD** button steps backwards through the measures of the pattern.



Alternatively, press the **←** cursor button to change the focus to the “MEASURE” prompt. The “MEASURE” prompt starts to flash. Select another measure by rotating the Jog Dial or by using the **+1** or **-1** buttons. Press the **→** cursor button to return to “PATTERN” selection.

■ Setting the Tempo

The preset patterns on the RY20 are programmed with an initial tempo. As long as the machine is stopped when you select a pattern, its initial tempo is loaded. If you select another pattern while the RY20 is playing, the new pattern will inherit the current tempo setting.

- 1 Modify the current tempo setting by pressing the **TEMPO** button to place the unit in Tempo Mode. Notice the “TEMPO” indicator flashing beside the current Tempo value.

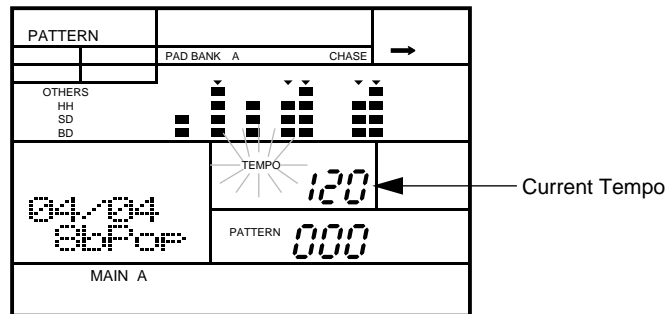

The tempo can be adjusted either when the RY20 is stopped or while it is playing a pattern or a song.

NOTE

You can also change the tempo while you are recording a pattern or a song.

- 2 Adjust the tempo by rotating the Jog Dial or by using the **+1** and **-1** buttons.

The playback tempo can be set to any value from 40 to 250 beats per minute.

NOTE

*Each pattern has been recorded with a specific tempo. Pressing the **+1** and **-1** buttons simultaneously resets the tempo to its default value.*

- 3 Press the **PATTERN** button to return to Pattern Mode.

NOTE

*Pressing the **TEMPO** button again is another method of switching the RY20 back to the previously selected main mode.*

■ Muting a Track

The RY20 records its patterns into four tracks. The tracks are Bass Drum, Snare Drum, High Hat, and Others.

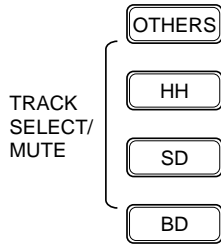

- 1 To mute a track, press the appropriate Track Select/Mute button. For example, to mute the percussion instruments or a bass part, press the **OTHERS** button.

The “MUTE” indicator lights up next to the word “OTHERS”.

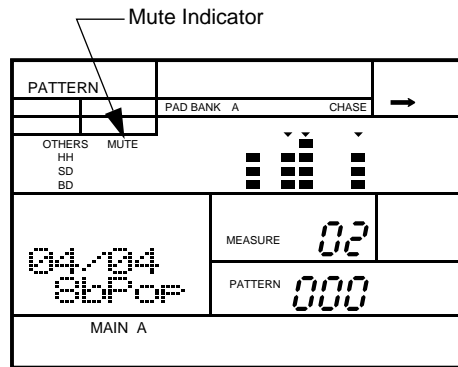

- 2 Press the key again to turn muting off.

4

Playing the Pads

The RY20 has 300 Advanced Wave Memory voices including standard drums and percussion, a range of electronic percussion sounds, and bass. You can assign its voices to individual drum kits. These kits can be selected and played using the 12 drum pads, or you can use a MIDI instrument connected to the MIDI IN connector.

Internal Layout

There are 20 preset drum kits and 20 user drum kits, each containing five drum banks and a bass bank.

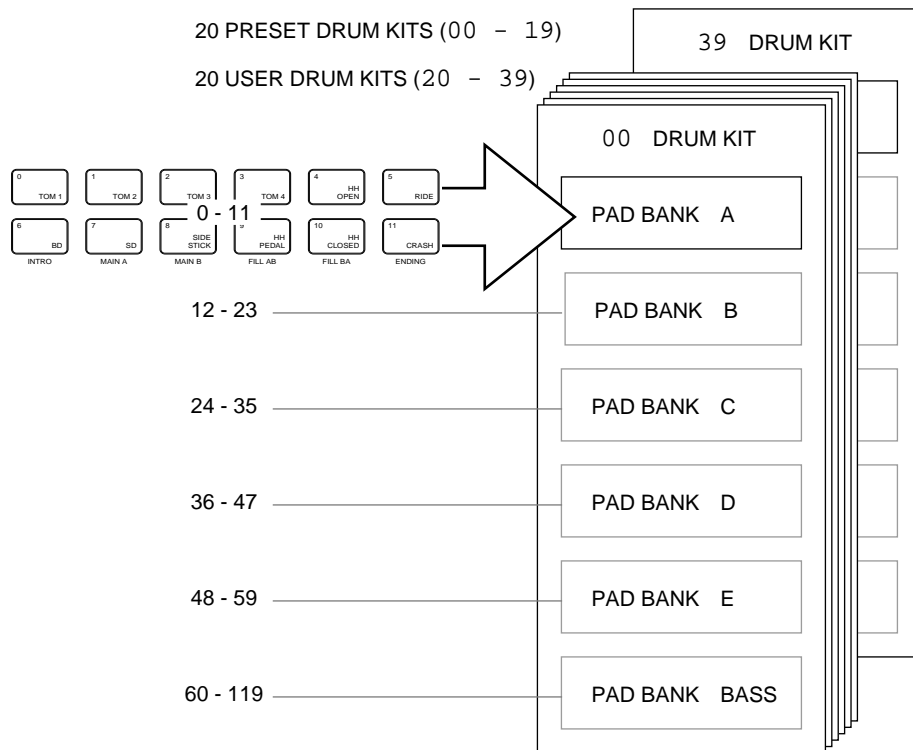

See page 24 for further details about the bass bank.

To play a voice, tap the appropriate drum pad.

The RY20 has 12 drum pads.

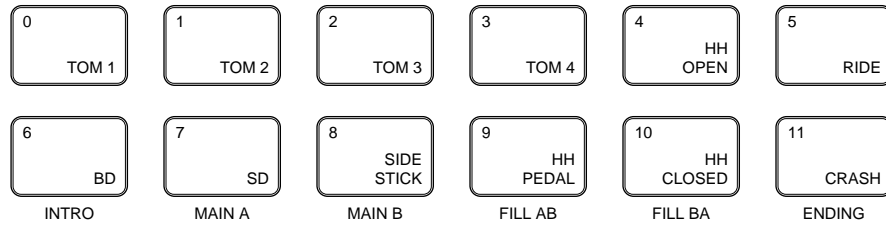

NOTE

The voices of the RY20 are fully programmable and can be assigned to any pad. The drum pads are labeled [0] through [11] and also have a drum name printed on each. The voice assigned to the pad may not correspond to the name printed on the pad. See page 83 for further details.

The drum pads are velocity sensitive. The harder you tap a pad, the louder the voice will play.

NOTE

The velocity sensitivity level (“SENS LVL”) and the pad sensitivity (“PADSNS”) settings determine the way in which the velocity sensitive feature works. See page 90 and page 98 for further details.

■ Selecting a Drum Kit



- 1 Place the unit in Drum Kit Mode by pressing the [DRUM KIT] button. The “DRUM KIT” indicator flashes beside the current drum kit number.

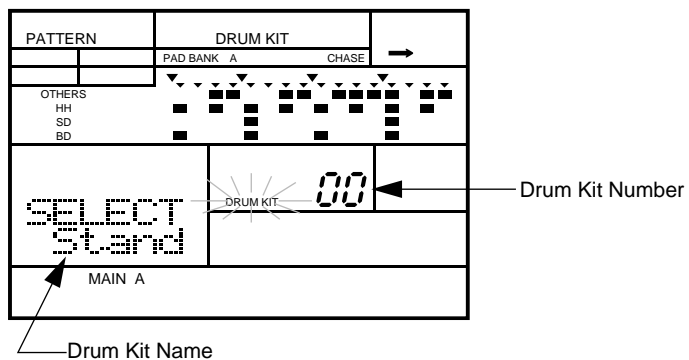

- 2 Select another drum kit by rotating the Jog Dial or by using the **[+1]** and **[-1]** buttons.

There are 20 preset drum kits, numbered “00” to “19”, and 20 user drum kits, numbered “20” to “39”, in the RY20. Refer to the Drum Kit list provided on page 124.

NOTE

Pressing the **DRUM KIT** button again will switch the RY20 back to the previously selected main mode, such as Pattern or Song Play mode.

■ Selecting a Pad Bank

- 1 Place the unit in Pad Bank Mode by pressing the **PAD BANK** button.

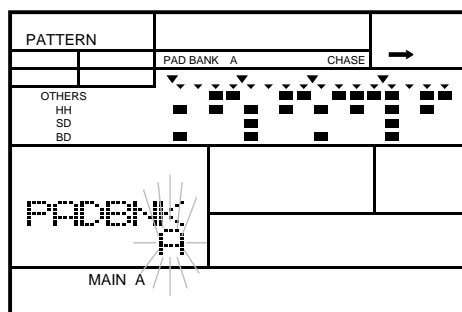

NOTE

Pressing the **PAD BANK** button again will switch the RY20 back to the previously selected main mode, such as Pattern or Song Play mode.

- 2 Select another pad bank by rotating the Jog Dial or by using the **[+1]** and **[-1]** buttons. Notice the change in the Pad Bank indicator.

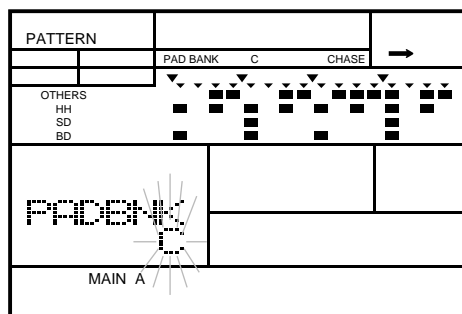

The RY20 has five pad banks labeled “A” to “E”. Each pad bank contains 12 drum pads. This indicates that a drum kit can accommodate 60 drum or percussion voices (pad numbers “00” to “59”). See page 83 for more information.

The Drum Kit list on page 124 shows the pad bank assignments for each voice in the preset drum kits.

NOTE

Changing the voice assignment of the drum kits will affect the voices of each pattern. This is because only the pad numbers are recorded in a pattern.

■ Playing the Bass Voices

When the RY20 is in bass mode, the drum pads function as a keyboard, with each key playing the bass voice at a different pitch.

The following diagram shows how the drum pads correspond to the layout of a standard keyboard.

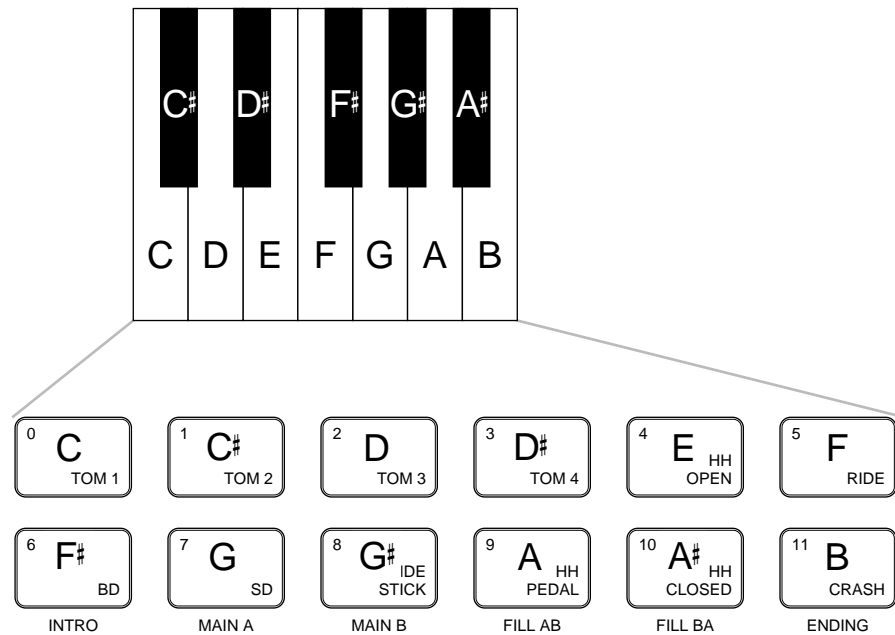

Bass Voice Layout

Each drum kit contains one bass bank. The bass bank is subdivided into five octaves (pad numbers “60” to “119”):

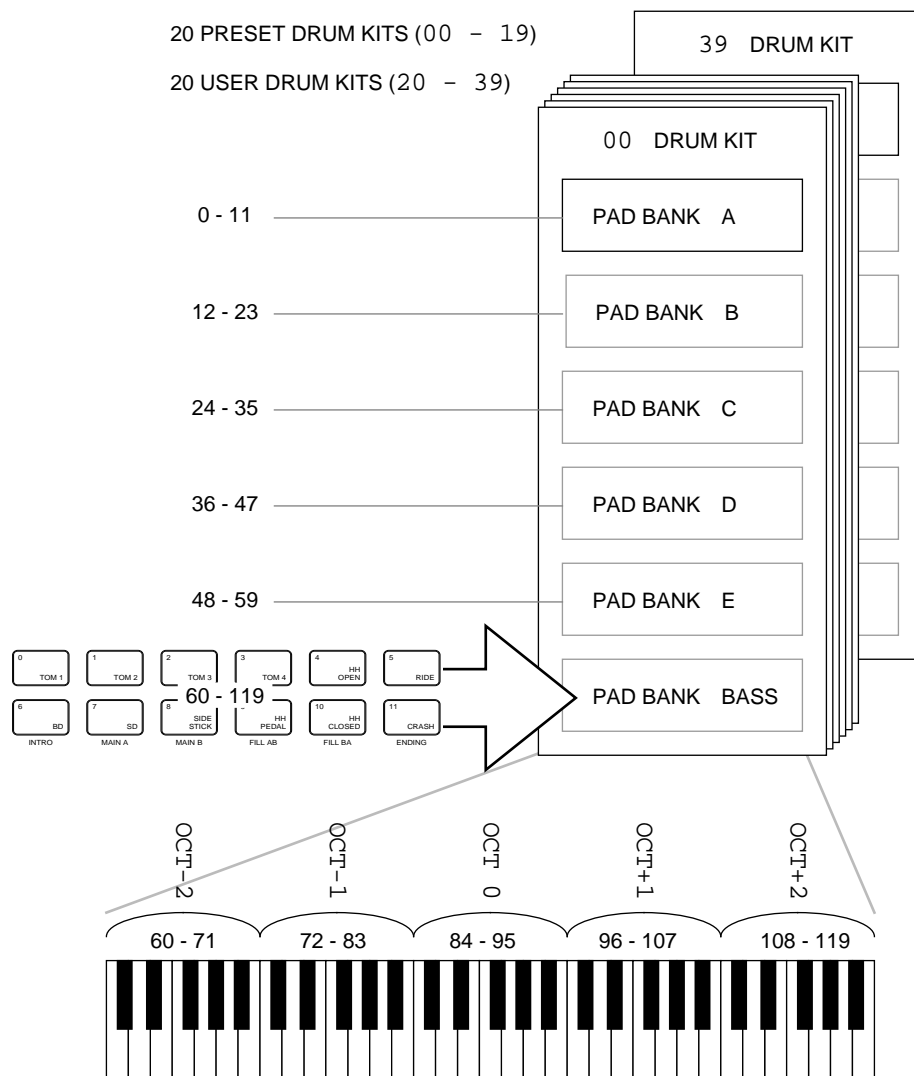



- 1 With the unit in Pad Bank Mode, press the **PAGE+** button to access the Type display page. This function allows you to switch between drum voices and bass voices.

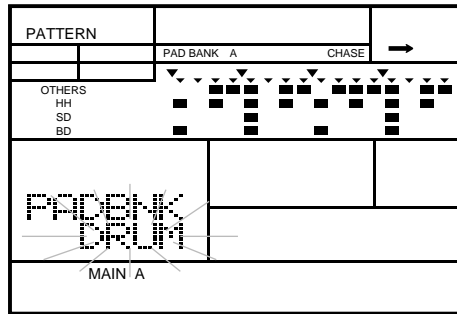

- 2 Change the type from “DRUM” to “BASS” by rotating the Jog Dial or by using the **+1** and **-1** buttons. Notice the Pad Bank indicator is now set to “BASS”.

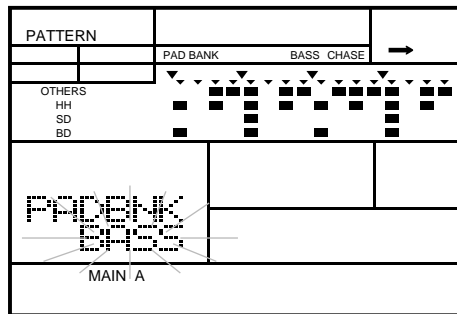

- 3 To return to Pad Bank Mode, press the **PAGE-** button. The display shows the current octave range.

When the RY20 is in bass mode, the five pad banks become five octave ranges from “OCT-2” to “OCT+2”.

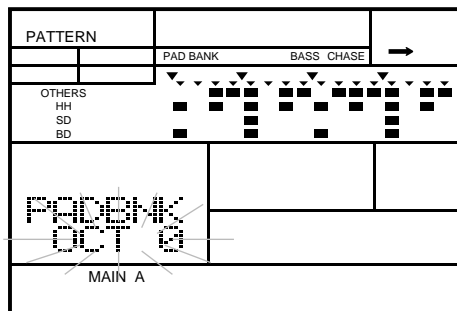

- 4** Select an octave range by rotating the Jog Dial or by using the **+1** and **-1** buttons.

You can assign any voice to the Bass pad bank. See page 83 for more information.

- 5** Place the unit in Drum Kit Mode by pressing the **DRUM KIT** button. The “DRUM KIT” indicator flashes beside the current kit number.

- 6** Select a kit by rotating the Jog Dial or by using the **+1** and **-1** buttons.

To play a voice, tap the appropriate drum pad.

5

Recording a User Pattern

The RY20 can record 50 original patterns in its internal memory. The internal memory saves your pattern data even if the power is shut off. There are two pattern record modes: Step Record Mode and Real-time Record Mode. You can also create a further 50 patterns by “combining” the preset and user patterns.

■ Recording Modes

Each method has its own advantages and uses. Step Record Mode is good for precision and for entering percussion sounds whose note placement has been determined, such as a bass drum that plays every beat of a measure. Real-time Record Mode is best for capturing the “feel” of a rhythm, because it allows you to actually play the pattern as you are creating it.

The method you choose depends partly on the type of rhythm you intend to create and partly on your own preference. You can even switch between the two while editing to create a single rhythm pattern using both methods. For example, you could program the basic beats of a rhythm with Step Record Mode, then use Real-time Record Mode to add percussion accents and embellishments.

IMPORTANT

If you attempt to record over or change the parameters of the preset patterns, numbered “000” to “049”, the message “PRESET” will momentarily appear on the display. You cannot record over a preset drum kit and there are also many parameters that you cannot change.

Step Record Mode

In this mode you enter one note at a time, rather than playing along with the click sounds. You can create very complex patterns that would be difficult to record using Real-time Record Mode.

- 1 Press the **PATTERN** button to place the unit in Pattern Mode. Notice that the “PATTERN” indicator is flashing beside the current Pattern Number. The current position “-” indicator is also flashing.

PATTERN

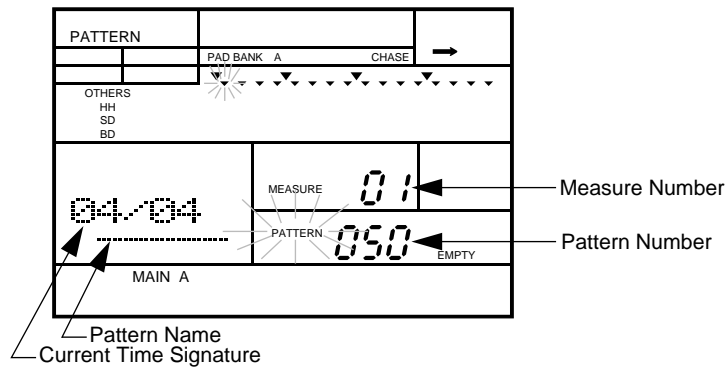

NOTE

See page 40 for a description of the indicators on the LCD.

- 2 Select a pattern from “050” to “099” to record into by rotating the Jog Dial or by using the **+1** and **-1** buttons. You should select an empty pattern to record into.

Patterns “000” to “049” are preset patterns and cannot be modified.

Patterns “100” to “149” are combination patterns and are recorded in a different manner. See page 38 for an explanation of how to record combination patterns.

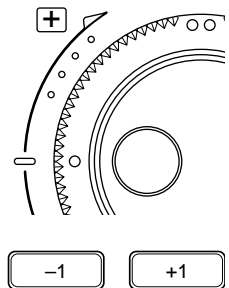

WARNING

Be careful not to overwrite a pattern accidentally. The “EMPTY” indicator will light for patterns that contain no data. If the pattern you have selected already contains data, you may want to clear it before you start to record a new pattern. See page 55 for further details.

- 3 Select a section of the pattern you want to create. Press and hold the **SECTION** button, then press the Drum Pad button for the section you want to record. The appropriate Section indicator lights up, for example, the “INTRO” indicator.

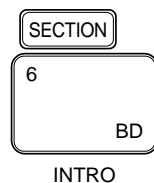

INTRO

HINT

You can select another section while you are recording. This allows you, for example, to record the intro of a pattern and then work on the verse /chorus section.

You can also change both the Drum Kit and the current Pad Bank as you record your pattern.

After you select a pattern, you should find and select a suitable Drum Kit. The Drum Kit should contain the drum and percussion voices you want to use to create your pattern.

Selecting a Drum Kit



Place the unit in Drum Kit Mode by pressing the **DRUM KIT** button. The “DRUM KIT” indicator flashes. Select another drum kit by rotating the Jog Dial or by using the **+1** and **-1** buttons.

If a suitable kit cannot be found, you should create one with one of the user drum kits. See page 83 for instructions.

Selecting a Pad Bank



Place the unit in Pad Bank Mode by pressing the **PAD BANK** button. Select another pad bank by rotating the Jog Dial or by using the **+1** and **-1** buttons.

These two steps are entirely optional.

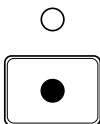

4 Start recording by pressing the **RECORD** button. The red Record LED lights, and the “QUANTIZE” indicator and the current position “v” indicator both flash.

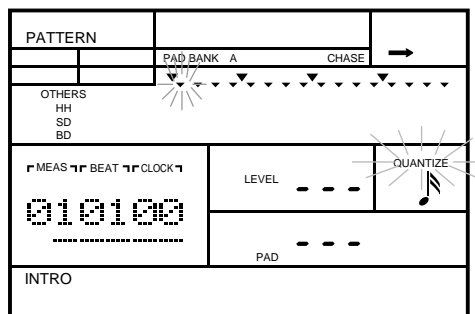

NOTE

The default quantization value is to resolve to 16th notes. You can change the quantization value at any time during the recording of a pattern. See page 44 for further details.

The default time signature is 4/4 and the default pattern length is two measures. Both of these values are easily changed, however you can only change them before you record anything into the pattern. Refer to page 46.

5 Use the drum pads to record your pattern.

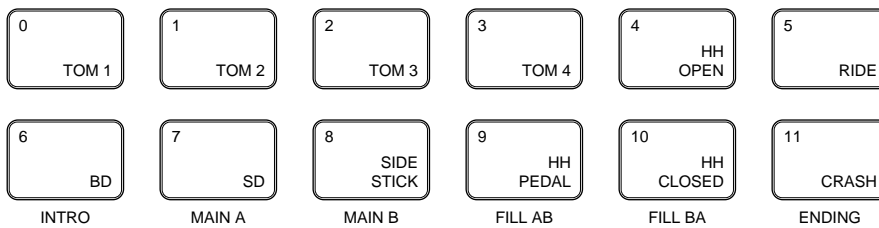
**NOTE**

Each pad has a voice associated with it. The voice depends on which Drum Kit and which Pad Bank you have selected. Each voice is associated with a track. For example, all the bass drum voices are associated with the “BD” track and the snare drum voices are all assigned to the “SD” track.

The tracks cannot be muted in Pattern Record Mode.

Each time you tap a pad, the voice is recorded, the note “ ■ ” indicator also lights up for the appropriate track, and the RY20 moves to the next beat. The measure, beat, and clock numbers are updated and the flashing current point “ · ” indicator moves as well, giving you a visual prompt to your present position in the pattern.

NOTE

Details about the items displayed on the LCD in Pattern Record Mode are explained starting on page 39.

The harder you tap a pad, the louder the associated voice will sound.

HINT



The RY20 provides the **AUDITION** button to allow you to play a drum pad while pattern record is active, without actually recording the voice associated with the pad.

Press and hold the **AUDITION** button, then tap any drum pad. The voice will sound, but will not be recorded.



To skip a beat, press the **FORWARD** button. The flashing current position “-” indicator will move to the next beat. Each time you press the **FORWARD** button, the RY20 moves forward to the next beat.

Through a combination of tapping the drum pads and pressing the **FORWARD** button, you will soon cover the two default measures.

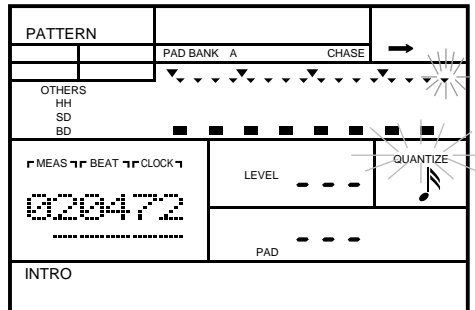

When you have completed the two measures, the RY20 loops back to the beginning of the pattern.

This feature allows you to layer your pattern. For example, start by recording the bass drum part. After you have recorded two measures of bass drum parts, record the snare drum part.



If you missed a beat, or accidentally skipped a beat, you can step back with the **BACKWARD** button.

NOTE

The behavior of the **FORWARD** and **BACKWARD** buttons is explained in more detail starting on page 41.

6 Stop recording by pressing the **RECORD** button again. The red Record LED turns off and the RY20 returns to Pattern Mode.

NOTE

If you have recorded a long and complex pattern, the RY20 may need a short time to arrange the data in its memory. In this case the prompt “PLEASE WAIT” may momentarily appear on the display,

IMPORTANT

Depending on the amount of data you have recorded, it may not be possible to fully record all the available user patterns. If you run out of memory during recording, the error message “MEMORY FULL” will appear on the display. If this happens, use the Clear Pattern function described on page 55 to clear unwanted pattern data.

You may also want to use a MIDI data storage device such as the Yamaha MDF2 MIDI Data Filer to save your important data to floppy disk for later loading and use.

WARNING

Turning the power off while Pattern Record Mode is active may cause irretrievable loss of ALL the user data.

Play the Pattern

You can review your pattern at any time.

- 1** Press the **PLAY** button to start the pattern. The green Play LED will flash in time with the current tempo setting and the pattern will begin playback.

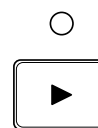
**NOTE**

You can change the tempo as the pattern plays. See page 19 for further details. Also see page 44 about recording an initial tempo into your pattern.

The RY20 always remembers the last tempo you entered for a user pattern.

- 2** Press the **STOP** button to stop playing the pattern. The green Play LED stops flashing.

**An Example Pattern**

Start the recording by pressing the **RECORD** button. The RY20 defaults to the first beat of the pattern.

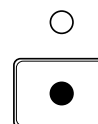

NOTE

This example will record a bass drum on every 1/4 note. These instructions assume the defaults: a “04/04” pattern and 16th note quantization.

See page 46 for information about changing the meter and page 44 for quantization details.

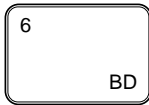

INTRO

Tap the **6 - BD** drum pad. The note is recorded, the clock is updated to “24”, and the note indicator lights up.

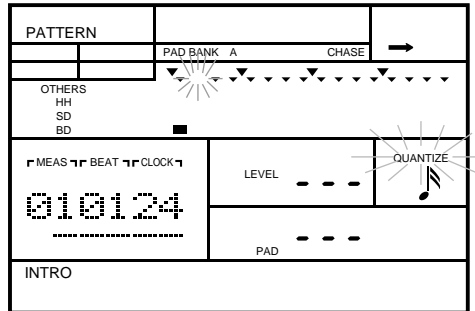

Skip the next three beats by pressing the **FORWARD** button three times. Then tap the **6 - BD** drum pad again to enter the second bass drum beat.

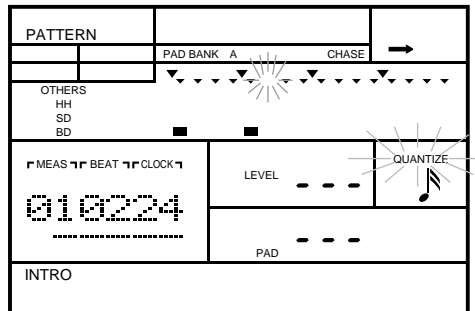

Repeat for the remaining two bass drum beats of the measure.

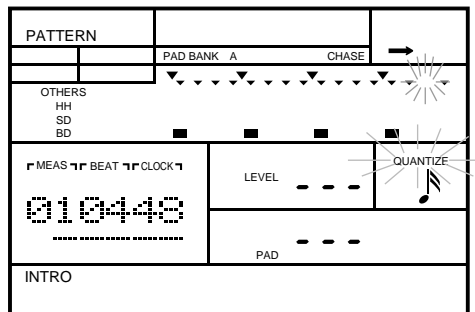

Complete the second measure by repeating the above procedure. Once the RY20 has looped back to the beginning of the first measure, you can record the snare drum, hi-hat, or other parts.

If you make a mistake, you can delete the unwanted note very easily. The procedure is shown starting on page 42.

HINT

The *pattern Copy* function described on page 57 can make the process of creating patterns faster and more efficient.

Real-time Record Mode

Real-time recording allows you to record a pattern as you play the drum pads in real time. You can switch to and from real-time mode at anytime during the recording of your pattern.

- 1 Select a pattern and start the recording by pressing the **RECORD** button.

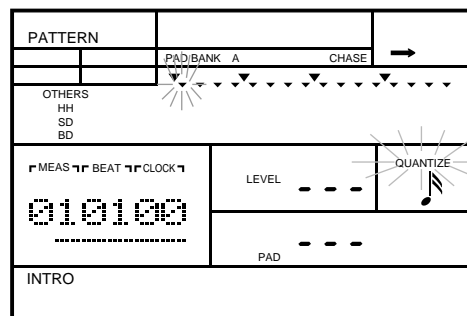

- 2 Press the **PLAY** button to start recording in real-time. The green Play LED will flash in time with the current tempo setting, you will hear the click sound, and the RY20 will countdown two measures before you begin.

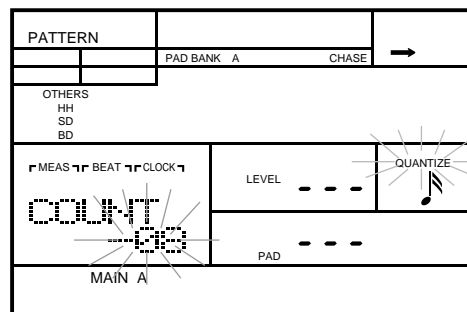

NOTE

You can adjust both the volume level and the quantization of the click sound. Refer to page 47.

3 Play the drum pads to record your pattern.

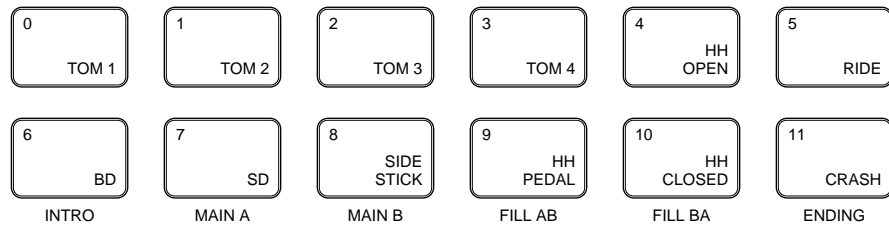

When you tap a pad, the appropriate Voice Level indicator lights up on the LCD. As on a VU meter, more indicators light up the harder you tap the pad.

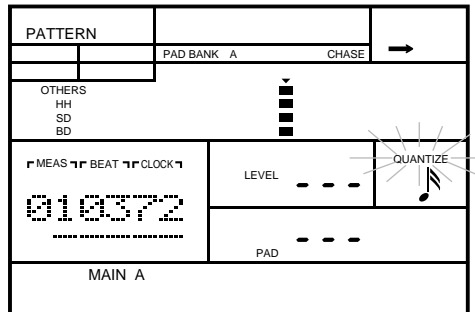

Voice Level Indicators

Each drum pad is associated with a Voice Level indicator. In this example, the **6 - BD** pad is being tapped.

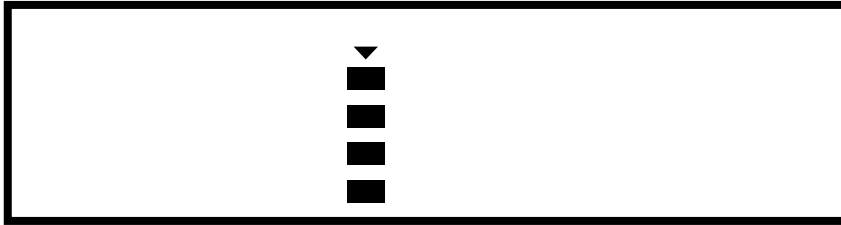

0	1	2	3	4	5	6	7	8	9	10	11	Drum Pad Bank A
12	13	14	15	16	17	18	19	20	21	22	23	Drum Pad Bank B
24	25	26	27	28	29	30	31	32	33	34	35	Drum Pad Bank C
36	37	38	39	40	41	42	43	44	45	46	47	Drum Pad Bank D
48	49	50	51	52	53	54	55	56	57	58	59	Drum Pad Bank E
60	61	62	63	64	65	66	67	68	69	70	71	Bass Pad Bank Oct -2
72	73	74	75	76	77	78	79	80	81	82	83	Bass Pad Bank Oct -1
84	85	86	87	88	89	90	91	92	93	94	95	Bass Pad Bank Oct 0
96	97	98	99	100	101	102	103	104	105	106	107	Bass Pad Bank Oct +1
108	109	110	111	112	113	114	115	116	117	118	119	Bass Pad Bank Oct +2

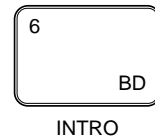
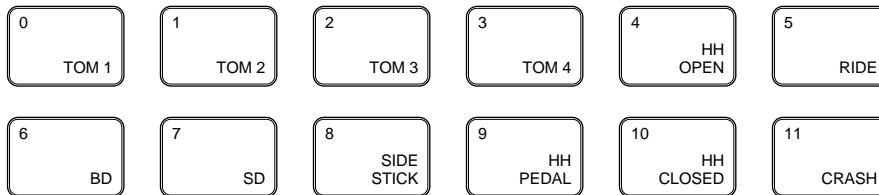

As the RY20 loops through your pattern, you will also hear the previously recorded instruments. They will also cause the Voice Level indicators to light up.

- 4** Press the **STOP** button to stop the real-time record. The green Play LED stops flashing. However, the RY20 is still in record mode, allowing you to continue adding to your pattern.



■ Combination Patterns

A unique feature of the RY20 is its ability to create “combination” patterns. A combination pattern is constructed by selecting tracks from the preset and user patterns.

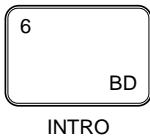

- 1 Select a section of the pattern. Press and hold the **SECTION** button, then press the Drum Pad button for the section you want to record. The appropriate Section indicator lights up, for example, the “INTRO” indicator.

NOTE

As you record your combination pattern, you can select other sections as you need.

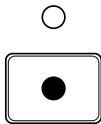

- 2 Select a pattern from “100” to “149” to record into by rotating the Jog Dial or by using the **+1** and **-1** buttons. Start recording by pressing the **RECORD** button.

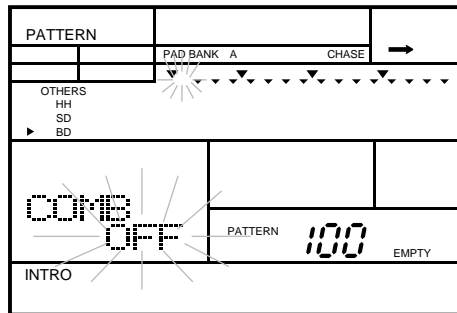

The initial track selected is the “BD” - bass drum - track. Notice the track “▶” indicator is lit. You can change tracks by pressing the appropriate Track Select/Mute button.

NOTE

Although you are using other patterns, the combination pattern controls the time signature and the number of measures. You can use patterns with different time signatures (“METER”) and/or measure numbers. A shorter pattern will be padded out by a number of repetitions of itself and a longer pattern will be truncated. This will not change the data in the original pattern.

You can also apply swing and groove to the combination pattern without affecting the data in the original pattern. See page 46 for further details.

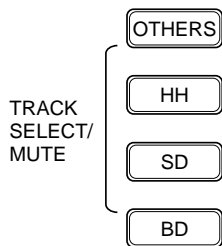

- 3 Select the bass drum track of another pattern by rotating the Jog Dial or by using the **+1** and **-1** buttons. Notice that the pattern number changes under the “COMB” prompt.

The range of patterns available is “000” to “099” or “OFF”. “000” to “049” are the preset patterns, “050” to “099” are the user patterns.

- 4** Select another track to record by pressing the appropriate Track Select/Mute button. For example, select the snare drum track by pressing the **[SD]** button. Then select the snare drum track of another pattern by rotating the Jog Dial or by using the **[+1]** and **[-1]** buttons.
- 5** Continue selecting tracks and locating the desired patterns until you are satisfied with your pattern.
- 6** Stop the recording by pressing the **[RECORD]** button again.

A Note on Instrument Polyphony

The RY20 has 28-note polyphony. This simply means it can reproduce a maximum of 28 individual sounds at the same time. You can easily record notes in excess of the maximum polyphony. The RY20 will record these notes without difficulty. However on playback, some of the notes will be truncated and will therefore not sound.

Some of the voices use more than one element. Each element uses one note of the instrument’s polyphony. When notes with multiple elements are recorded in your pattern, the maximum polyphony actually becomes less than 28 notes. Please refer to the number of elements listed in the table on page 124.

Back-up Your Data

The RY20 is a powerful and reliable instrument. Its internal memory saves your pattern data even if the power is shut off. However, accidents are possible. To protect yourself against loss, you should use a MIDI data storage device such as the Yamaha MDF2 MIDI Data Filer to save your valuable data to floppy disk.

The procedure for MIDI back-up is shown starting on page 118.

■ Editing Patterns

The RY20 has extensive features to support the creation and editing of pattern data.



1 Press the **PATTERN** button to place the unit in Pattern Mode.

Select a pattern by rotating the Jog Dial or by using the **+1** and **-1** buttons.

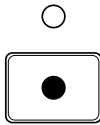

2 Start recording by pressing the **RECORD** button. The red Record LED lights and the “QUANTIZE” indicator and the current position “-” indicator both flash.

LCD Panel

The following illustration points out some key indicators on the LCD panel when the RY20 is in Pattern Record Mode.

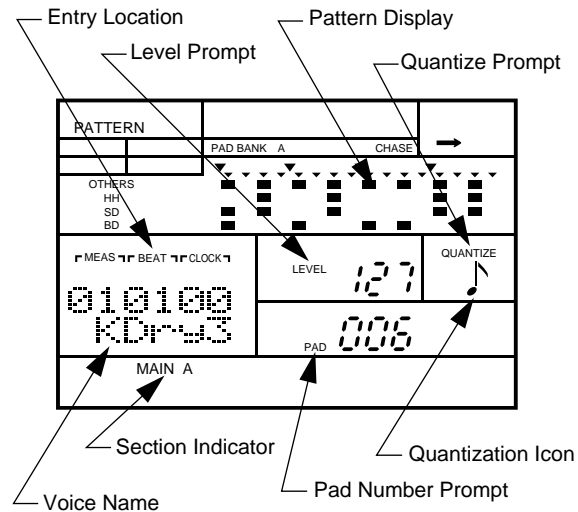

The **Entry Location** shows, from left to right, the measure, beat, and clock number of the pattern section. These parameters show you which location you are currently at.

In real-time record, this is the only visual indication you have of the location of the current position.

The **Level Prompt** shows the recorded level of the pad at the current insert location. If there is no event recorded at this location, the display shows “---”. You can edit the level of each recorded note at any time during Pattern Record Mode.

The **Pattern Display** is the section of the LCD panel that shows the pattern data and status. See below.

The **Quantize Prompt** and **Quantization Icon** show the current quantization level. See page 44 for further details.

The **Voice Name** is the preset five character name for the voice assigned to the current pad. If there is no voice recorded at this location, the display shows “-----”.

The **Section Indicator** shows which pattern section you are working on.

The **Pad Number Prompt** shows which pad was recorded at the current insert location. If there is no event recorded at this location, the display shows “---”. You can select another pad for each recorded note at any time during Pattern Record Mode.

Pattern Display

A more detailed view of the portion of the LCD panel that shows the pattern data and status.

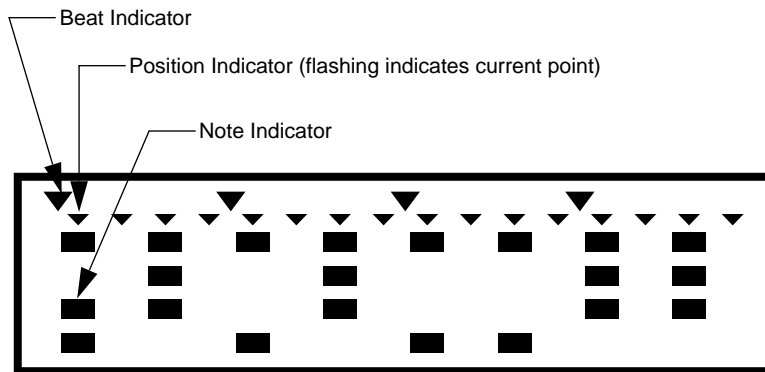

The **Beat ▾ Indicator** shows the quarter note divisions of the measure and changes depending on the quantization.

The **Position ▾ Indicator** shows the possible note locations for the current quantization level. The flashing position indicator shows the current point in the pattern.

The **Note ■ Indicator** shows that an instrument has been recorded on one of the four tracks at this position.

Editing Buttons

The **FORWARD**, **BACKWARD**, and **TOP** buttons are designed to allow you to move quickly through the pattern and efficiently edit your pattern data.

Use the **FORWARD** button to move forward through your pattern. It stops at each available note position. The maximum number of note positions to a beat is 96. The number of available positions in a beat is determined by the quantization setting. See page 44 for details about quantization.



If an instrument event has been recorded, the display is updated as follows:

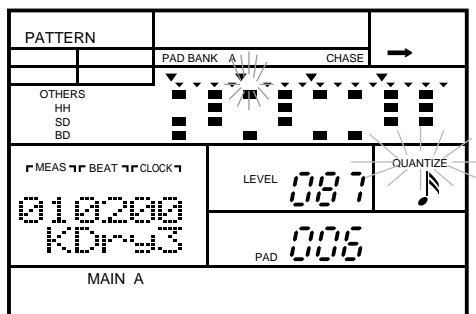

If there is more than one note recorded at a position, the RY20 steps through each event, in the recorded order, as you press the **FORWARD** button.



Use the **BACKWARD** button to go back to a previous note. It functions in a similar fashion to the **FORWARD** button.

NOTE

Instead of the **FORWARD** or **BACKWARD** buttons, you can use the Jog Dial or the **+1** and **-1** buttons to easily change the current location.



Use the **◀** or **▶** cursor buttons to change the focus to the “MEAS | BEAT | CLOCK” indicators. Select another location within the pattern by rotating the Jog Dial or pressing the **+1** and **-1** buttons.



Use the **TOP** button to return to the beginning of the pattern.

Deleting Voices

A single note can be deleted from your pattern.



Use the **FORWARD** and **BACKWARD** buttons to move the position pointer to the event you want to delete. Press and hold the **DELETE CLEAR** button. The “DEL” indicator lights up.

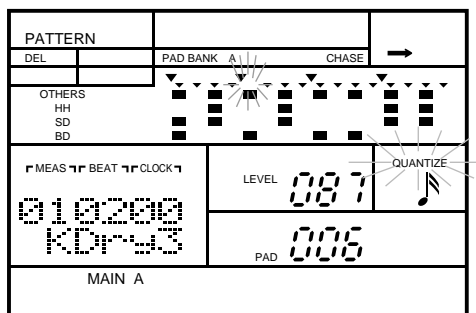

Press the appropriate drum pad, for example, the **6 - BD** pad. The note indicator for the event turns off.



INTRO

IMPORTANT

If you decide that you **DO NOT** want to delete a note from the pattern, you can cancel this operation by simply releasing the DELETE **CLEAR** button.

NOTE

An alternate method is to press and hold the DELETE **CLEAR** button and then press the **ENTER** button while the position pointer is at the note you want to delete. In this case, only the selected note will be deleted.



Modifying the Level or Pad

You can change the level or pad of an event.

Use the **FORWARD** and **BACKWARD** buttons to locate the note event. Press the **◀** cursor button to change the focus to the “LEVEL” prompt.

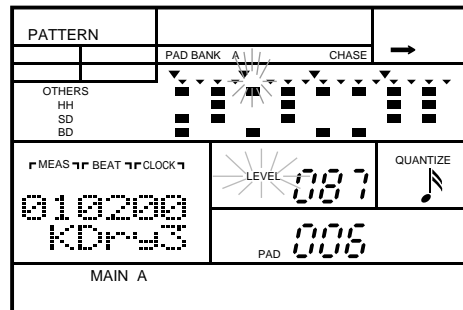

Change the level by rotating the Jog Dial or by using the **+1** and **-1** buttons.

NOTE

The level value changes in increments of 4. For example, increasing the level “087” (shown above) by one step changes it to “091”.

Press the **◀** cursor button again to change the focus to the “PAD” prompt. Select another pad by rotating the Jog Dial or by using the **+1** and **-1** buttons.

NOTE

As you change the pad number, notice that the Note indicator changes from track to track. Also, see the note on page 42 for an alternative way of accessing a note event.

Setting the Tempo

Set the tempo for your new pattern.



- 1 Press the **TEMPO** button to place the unit in Tempo Mode. Adjust the tempo by rotating the Jog Dial or by using the **+1** and **-1** buttons.

The tempo can be set to any value from 40 to 250 beats per minute.

NOTE

Pressing the **+1** and **-1** buttons simultaneously resets the tempo of the user pattern to 120 beats per minute.

- 2 Press the **PATTERN** button to return back to Pattern Record Mode.

NOTE

Pressing the **TEMPO** button again is another method of switching the RY20 back to Pattern Record Mode.

■ Quantization

Quantization helps to produce a “tight” recording by automatically aligning notes to the nearest specified beat as you record. You can change the quantization value at any time during the recording of a pattern.



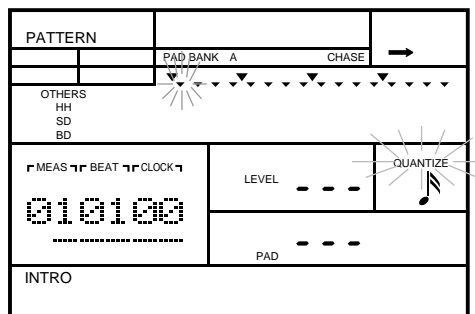



- 1 When you press the Record button, the “QUANTIZE” indicator flashes, indicating that this is the current focus of the display (the current position “-” indicator also flashes)



- 2** Set a new quantization value by rotating the Jog Dial or by using the **[+1]** and **[-1]** buttons.

The RY20 has seven levels of quantization. The coarsest level of quantization is resolution to eighth notes and the finest level is no quantization, “OFF”, which resolves to a 96th note.

The quantization values are:

-  = eighth note.
-  = eighth note triplet.
-  = 16th note.
-  = 16th note triplet.
-  = 32nd note.
-  = 32nd note triplet.
- “OFF” = 96th note.

A recommended approach is to use eighth note or eighth note triplet quantization to record the basic portions of your pattern, such as the bass drum. As you add to your pattern you can use a finer quantization value to increase its complexity.

■ Gate Time

Gate time is used to adjust the duration of a note. It is most effective when used with Note Driven voices (see page 97).

- 1** Select the Gate display page by pressing the **[PAGE+]** button. The display indicates “GATE” and the current value flashes.

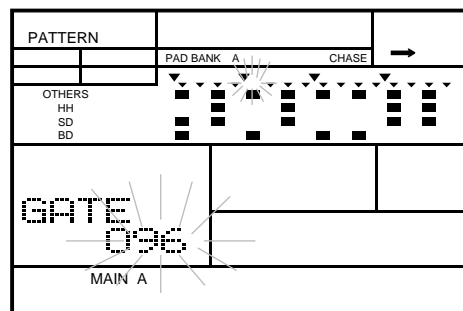

- 2 Change the value by rotating the Jog Dial or using the **[+1]** and **[-1]** buttons.

The range is from “004” to “508”.

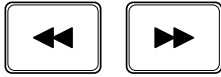

The gate value applies only to the current position within the pattern. Select another position in the pattern. Press the **[PAGE-]** button to return to Pattern Record Mode. Use the **[FORWARD]** or **[BACKWARD]** button to select a new position. Then repeat the preceding two steps.

NOTE

You can only change the gate value for a pattern position that has data in it. If there is no data at a position in the pattern, the gate value is “---”.

■ Changing the Meter

Before you record data into a pattern, you can adjust the time signature and the number of measures.



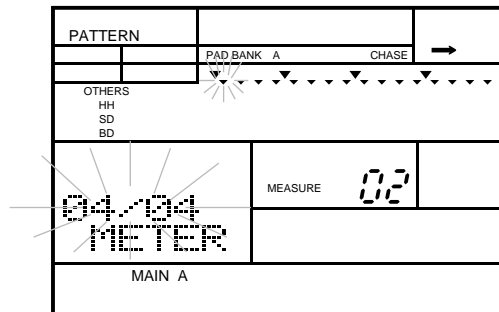

- 1 Select the Meter display page by pressing the **[PAGE+]** button. The display indicates “METER” and the current time signature flashes.



- 2 Set the time signature by rotating the Jog Dial or using the **[+1]** and **[-1]** buttons.

The default time signature is “4/4”. The range of time signatures is from “1/4” to “8/4”, “1/8” to “16/8”, and “1/16” to “32/16”.

- 3** Set the number of measures by using the  cursor button to change the focus to the “MEASURE” prompt. Change the number of measures by rotating the Jog Dial or using the  and  buttons.



The default length is “02” measures. The range is “01” measure to “16” measures.

NOTE

The meter and number of measures in a pattern that contains data cannot be changed. If you try to change these values, the message “NOT EMPTY” will momentarily appear on the display.

■ Adjusting the Click

The RY20 has a built-in click sound which sounds on each beat of the measure to serve as a rhythmic guide when you record in Real-time Mode. You can change both the volume and the quantization of the click sound.

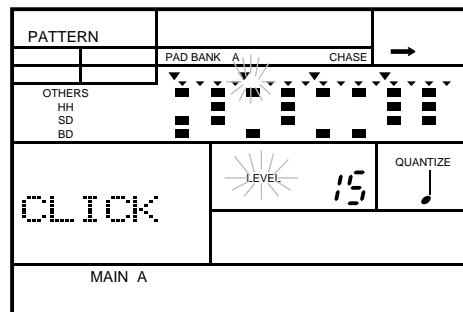

- 1** Select the Click display page by pressing the  button until the display indicates “CLICK”.





- 2** Set the volume by rotating the Jog Dial or using the  and  buttons.

The default volume level is “15”. The range is from “00” to “15”.





NOTE

Pressing the  and  buttons simultaneously resets the level to “00”.



- 3** Set the quantization by using the  cursor button to change the focus to the “QUANTIZE” prompt. Change the value by rotating the Jog Dial or using the  and  buttons.

The default quantization is quarter note. The quantization values are:

-  = quarter note.
-  = eighth note.
-  = eighth note triplet.
-  = 16th note.
-  = 16th note triplet.

NOTE

Changing the click level or quantization in Pattern Record Mode also changes it in Song Record Mode.

6

Other Pattern Functions

There are additional functions in Pattern Play Mode, helping you to precisely complete your own patterns.

Swing

Swing gives your patterns a looser, “swing” feel by slightly delaying the even-numbered eighth or 16th notes. Each pattern can be programmed with a different swing setting. You can modify the swing at anytime, while the RY20 is stopped or during playback.

- 1 Press the **PATTERN** button to put the RY20 into Pattern Mode. Select a pattern by rotating the Jog Dial or using the **+1** and **-1** buttons.



- 2 Select the Swing display page by pressing the **PAGE+** button. The display indicates “SWING” and the current value (“OFF”) flashes.

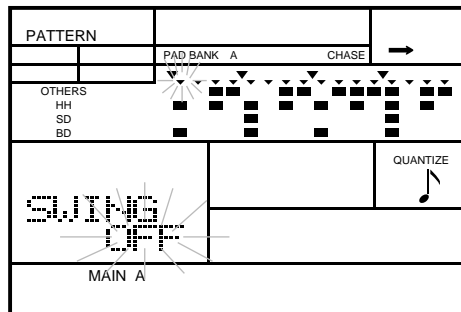

- 3 Set the swing by rotating the Jog Dial or using the **+1** and **-1** buttons.



NOTE

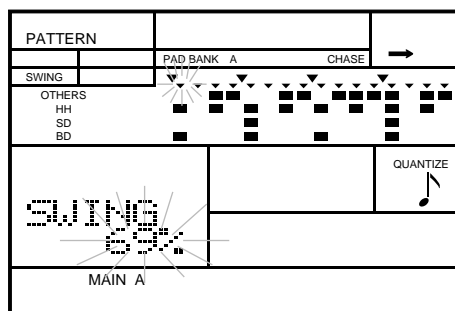

The “SWING” indicator will appear on the top of the LCD when any swing parameter other than “OFF” is selected. It will remain lit for the selected pattern as long as a swing function is active.





The range is from “51%” to “99%” or “OFF”.



- 4** The default quantization is eighth notes. To change the quantization press the  cursor button to change the focus to the “QUANTIZE” prompt. Change the value by rotating the Jog Dial or using the  and  buttons.



The values are  = eighth notes or  = 16th notes.

NOTE

Pressing the  and  buttons simultaneously resets both the Swing and Quantize values to their default.

■ Groove

Groove adds a human rhythm feel by changing the velocity, timing, or quantization values of a pattern. Each pattern can be programmed with a different groove setting. You can modify the groove at anytime, while the RY20 is stopped or during playback.

- 1** Press the  button to put the RY20 into Pattern Mode. Select a pattern by rotating the Jog Dial or using the  and  buttons.

- 2** Select the Groove display page by pressing the **PAGE+** button until the display indicates “GROOVE” and the current value (“OFF”) flashes.

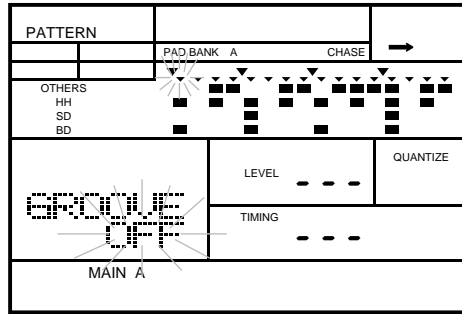

- 3** Select the groove by rotating the Jog Dial or using the **+1** and **-1** buttons.

NOTE

The “GROOVE” indicator will appear on the top of the LCD when any groove parameter other than “OFF” is selected. It will remain lit for the current pattern as long as a groove function is active.

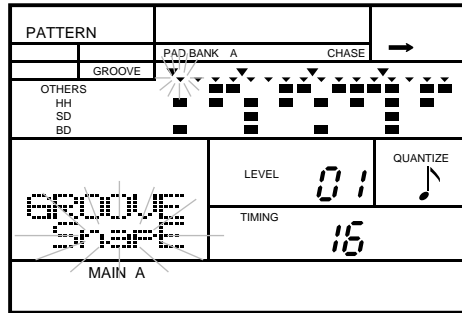

The default is “OFF”. There are 14 groove types, each modifies your pattern in different ways:

- HevyE
Heavy Even

Increase the velocity of notes that fall on the beat and decrease the velocity of all other notes. Delay the even-numbered beats.
- Hevy2
Heavy 2nd



Increase the velocity of notes that fall on the beat and decrease the velocity of all other notes. Delay the second beat of each measure.
- Hevy4
Heavy 4th

Increase the velocity of notes that fall on the beat and decrease the velocity of all other notes. Delay the fourth beat of each measure.
- SnapE
Snap Even

If there is a snare on the even-numbered beats, repeat it after a delay of an eighth note, a dotted eighth note, or a sixteenth note. Any note on an even-numbered beat is shifted forward in time.



<p>Snap2 Snap 2nd</p>	<p>If there is a snare on the second beat of the measure, repeat it after a delay of an eighth note, a dotted eighth note, or a sixth note. Any note on the second beat of each measure is shifted forward in time.</p>
<p>Snap4 Snap 4th</p>	<p>If there is a snare on the fourth beat of the measure, repeat it after a delay of an eighth note, a dotted eighth note, or a sixth note. Any note on the fourth beat of each measure is shifted forward in time.</p>
<p>Snp2V Snap 2nd and Velocity Change</p>	<p>Increase the velocity of the first note of a group of eighth note, eighth note triplet, or 16th note hi-hat, ride, cup, and percussion beats. Decrease the velocity of the last note of the group. If there is a snare on the second beat, repeat it after a delay of an eighth note, a dotted eighth note, or a sixth note.</p>
<p>OfBtE Off Beat and Even Delay</p>	<p>Decrease the velocity of the first note of a group of eighth note, eighth note triplet, or 16th note hi-hat, ride, cup, and percussion beats. Increase the velocity of the last note of the group. Delay the even-numbered beats.</p>
<p>OfBt2 Off Beat and 2nd Delay</p>	<p>Decrease the velocity of the first note of a group of eighth note, eighth note triplet, or 16th note hi-hat, ride, cup, and percussion beats. Increase the velocity of the last note of the group. Delay the second beat of each measure.</p>
<p>OfBt4 Off Beat and 4th Delay</p>	<p>Decrease the velocity of the first note of a group of eighth note, eighth note triplet, or 16th note hi-hat, ride, cup, and percussion beats. Increase the velocity of the last note of the group. Delay the fourth beat of each measure.</p>
<p>TrplD Triplet Delay</p>	<p>Increase the velocity of the first note of a eighth note triplet hi-hat, ride, cup, and percussion beat and decrease the velocity of the last. Delay the last note of the triplet.</p>
<p>TrplA Triplet Advance</p>	<p>Increase the velocity of the first note of a eighth note triplet hi-hat, ride, cup, and percussion beat and decrease the velocity of the last. Shift the last note of the triplet forward.</p>
<p>Loose Loose</p>	<p>If there is more than one note being played on a beat, delay each note by an equal amount, causing a smear of the rhythm.</p>
<p>Squeez Squeeze</p>	<p>Advance the timing of the notes in the first half of the quarter note and delay the notes in the last half.</p>

Groove has “LEVEL”, “TIMING”, and “QUANTIZE” settings. Available settings for each groove are shown on the display.

All three settings can be reset to their default values by pressing the  and  buttons simultaneously.

4 Change the focus to the “LEVEL” prompt using the  cursor button.





5 Modify the value by rotating the Jog Dial or using the  and  buttons.

The range is from “01” to “16” (full effect).

NOTE

If the “LEVEL” setting is inactive, it is indicated with a value of “---” on the display. Press the  cursor button again to skip the inactive setting.

6 Change the focus to the “TIMING” prompt using the  cursor button.

7 Modify the value by rotating the Jog Dial or using the  and  buttons.

The range is from “01” (slight delay) to “16” (extreme delay).



NOTE

If the “TIMING” setting is inactive, it is indicated with a value of “---” on the display.

8 Change the focus to the “QUANTIZE” prompt using the  cursor button.

9 Modify the value by rotating the Jog Dial or using the  and  buttons.

The repeat values are:

-  eighth note.
-  eighth note triplet.
-  16th note.

NOTE

If the “QUANTIZE” setting is inactive, the note icon at the right-center of the display will be off.

■ Velocity Modify

You can modify the velocity settings for an entire track. This function allows you to change the rate of velocity and the offset from the recorded values.

- 1 Press the **[PATTERN]** button to put the RY20 into Pattern Mode. Select a pattern by rotating the Jog Dial or using the **[+1]** and **[-1]** buttons.



- 2 Select Velocity display page by pressing the **[PAGE+]** button until the display indicates “VELCTY” and the current rate flashes. Also notice that one of the track “▶” indicators is lit.

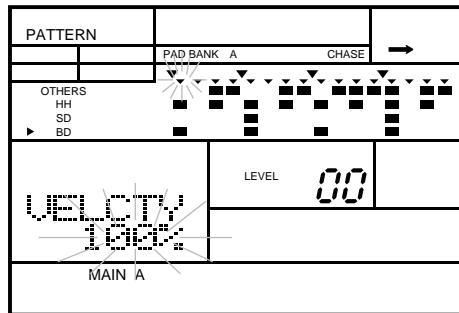

- 3 Select the track you wish to modify with the Track Select/Mute buttons. When you press a button, the track “▶” indicator for the current track switches off as the indicator corresponding to the selected track lights up.

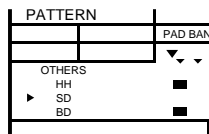
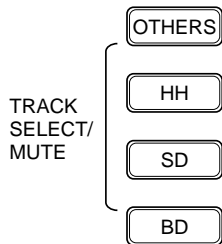

- 4 Alter the velocity rate by rotating the Jog Dial or using the **[+1]** and **[-1]** buttons.

The default rate is “100%” which is the normal setting. The range is from “000%” to “200%”. As you lower the rate below “100%”, all of the velocity settings are correspondingly reduced. When you raise the rate above “100%”, the velocity settings are correspondingly increased.

- 5 Change the focus to the “LEVEL” prompt using the **[▶]** cursor button.

- 6 Modify the value by rotating the Jog Dial or using the **+1** and **-1** buttons.

The default level is “00”. The range is from “-99” to “99”. The level value controls how much the volume will be changed from its recorded value. As the level is reduced, the volume of all the notes on the track is correspondingly lowered. When you raise the level, the volumes are correspondingly increased.

- 7 Select the next track you wish to modify with the Track Select/Mute buttons.

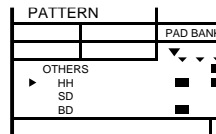

Repeat the above steps.

NOTE

You can reset each parameter to its default setting by pressing the **+1** and **-1** buttons simultaneously.

■ Clearing a Pattern

Clearing data from a user/combination pattern is a flexible operation. You can clear individual tracks or an entire section.

- 1 Press the **PATTERN** button to put the RY20 into Pattern Mode. Select a pattern by rotating the Jog Dial or using the **+1** and **-1** buttons.
- 2 Select the Clear display page by pressing the DELETE **CLEAR** button. The display indicates “CLEAR SURE?”.

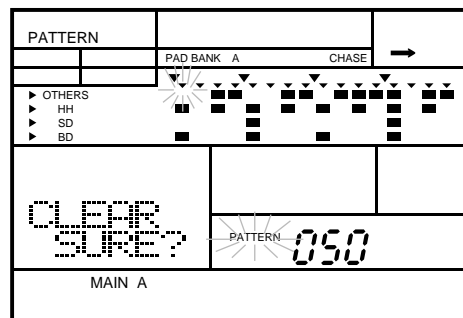



NOTE

You can also select the Clear display page by pressing the **PAGE+** or **PAGE-** buttons.

3 Select the section of the pattern you want to clear. Press and hold the **SECTION** button, then press the appropriate Drum Pad button. The appropriate Section indicator lights up, for example, the “INTRO” indicator.

4 Select the tracks you wish to clear with the Track Select/Mute buttons. Notice as you press a button, the track “▶” indicator for the corresponding track lights up.

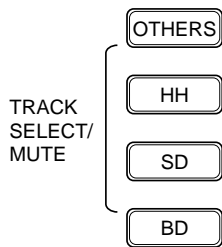

PATTERN		PAD BANK
OTHERS		▼
▶ HH		■
▶ SD		■
▶ BD		■

If you select a track by accident, just press the button again to switch it off.

IMPORTANT

If you decide that you **DO NOT** want to clear the pattern, you can cancel this operation by simply selecting another function. There are several ways to do this:

Press the **PATTERN** button to return to Pattern Mode.

Press the **PAGE+** or **PAGE-** buttons to select another display page.



5 Clear the selected tracks in the current section by pressing the **ENTER** button. The “END” prompt will momentarily appear on the LCD.

NOTE

If the selected pattern contains a lot of data, you may see the prompt “PLEASE WAIT” as the RY20 clears the data from the pattern.

When you see the “END” prompt, the RY20 has finished clearing the selected tracks.

WARNING

When you press the **ENTER** button the clear operation will be performed. It is not possible to recover data that you have lost by clearing the pattern.

PLEASE BE CERTAIN THAT THIS IS WHAT YOU INTEND TO DO.

NOTE

If you forget to select any tracks, the RY20 will prompt you with the error message "SELECT TRACK".

- 6** Select another section to clear by pressing the appropriate Drum Pad button while holding the **SECTION** button.

NOTE

The preset patterns "000" to "049" cannot be cleared. Also note that the pad bank selection and the tempo, swing, groove, and velocity settings of a user pattern cannot be cleared.

WARNING

Turning the power off during the execution of the clear function may cause the irretrievable loss of ALL user data.

■ Copying a Pattern

You can copy the data of any pattern to a user pattern numbered "050" to "099". This allows you, for example, to copy a preset pattern into a user pattern where you can then modify it.

- 1** Press the **PATTERN** button to put the RY20 into Pattern Mode. Select a pattern to copy from by rotating the Jog Dial or using the **+1** and **-1** buttons.

You can select any pattern from "000" to "149". The pattern you just selected is the Source Pattern.



2 Select the Copy display page by pressing the INSERT **COPY** button. The display reads “COPY SURE?”.

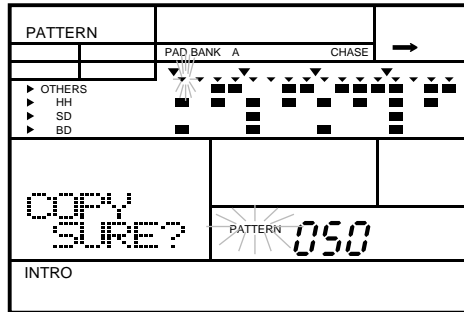

NOTE

You can also select the Copy display page by pressing the **PAGE+** or **PAGE-** buttons.

3 Select the pattern to copy to by rotating the Jog Dial or using the **+1** and **-1** buttons.

The pattern you just selected is the Destination Pattern. You must select a pattern from “050” to “099” as your destination pattern.



4 Select the section of the pattern you want to copy by pressing the appropriate Drum Pad button while holding the **SECTION** button.

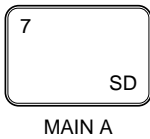

WARNING

Be careful not to overwrite a pattern accidentally. The “EMPTY” indicator will light for pattern sections that have no data. If the destination pattern you have selected already contains data, the copy function will overwrite that data on the selected tracks.

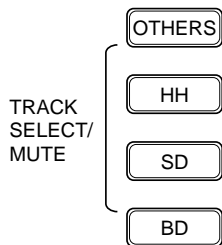

5 Select the tracks you wish to copy with the Track Select/Mute buttons. Notice as you press a button, the track “▶” indicator for the corresponding track lights up.

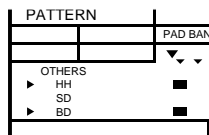

If you select a track by accident, just press the button again to switch it off.

- 6** Copy the selected tracks of the current section by pressing the **ENTER** button. The prompt “END” will momentarily appear on the LCD.

NOTE

If the source pattern contains a lot of data, you may see the prompt “PLEASE WAIT” as the RY20 copies the data to the destination pattern.

When you see the “END” prompt, the RY20 has completed copying the selected tracks from the source pattern to the destination pattern.

IMPORTANT

If you decide that you DO NOT want to copy a pattern, you can cancel this operation by simply selecting another function. There are several ways to do this:

*Press the **PATTERN** button to return to Pattern Mode.*

*Press the **PAGE+** or **PAGE-** buttons to select another display page.*

WARNING

*When you press the **ENTER** button, the copy operation will be performed. It is not possible to recover data that you have lost by overwriting the pattern.*

PLEASE BE CERTAIN THAT THIS IS WHAT YOU INTEND TO DO.

NOTE

If you forget to select any tracks, the RY20 will prompt you with the error message “SELECT TRACK”.

- 7** Select another section to copy by pressing the appropriate Drum Pad button while holding the **SECTION** button.

The pad bank selection and the tempo, swing, groove, and velocity settings of the source pattern are copied to the destination pattern.

NOTE

If you attempt to copy a track from the source pattern to a destination pattern that already contains data and the destination pattern has a different time signature from the source pattern, the message “TS NOT MATCH” will momentarily appear on the display. This means the time signatures do not match. Select an empty destination pattern or one with the same time signature as the source pattern.

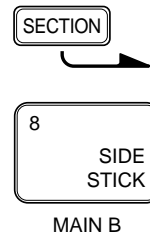

IMPORTANT

The error message “MEMORY FULL” may appear. See the important message on page 33 for details.

WARNING

Turning the power off during the execution of the copy function may cause the irretrievable loss of ALL user data.

■ **Setting the Pattern Name**

This mode allows you to assign a name of up to five characters to a user/combination pattern.

- 1 Press the **[PATTERN]** button to put the RY20 into Pattern Mode. Select a pattern by rotating the Jog Dial or using the **[+1]** and **[-1]** buttons.
- 2 Select Name display page by pressing the **[PAGE+]** button until the display indicates “NAME” and the name of the current pattern. Notice that the first character is flashing.

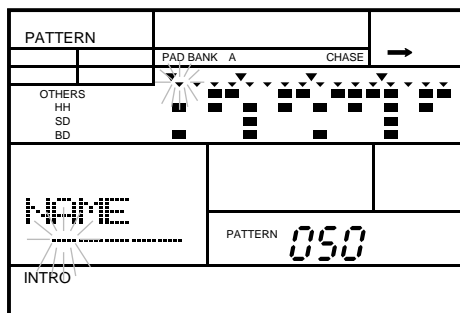



The default name for all user patterns is “-----”.

- 3 Select the first character of the name by rotating the Jog Dial or by using the **[+1]** and **[-1]** buttons.

NOTE

The RY20 contains the following character set, allowing you to use numbers, upper and lower case letters and symbols for your name.

(Space)
 □ ! " # \$ % & ' () * + , - . / 0 1 2 3 4 5 6 7 8 9 : ; < = > ? @ A B C D E F G H I J K L M N O P Q R S T U V W X
 Y Z [\] ^ _ ` a b c d e f g h i j k l m n o p q r s t u v w x y z { | } → ←

- 4** To move to the next character, press the  button. The second character will flash. Change that character by rotating the Jog Dial or by using the  and  buttons.

- 5** Repeat the previous step until you have finished creating the name for your pattern.

7

Recording a Song

The RY20 can record 50 original songs, each consisting of as many patterns as you want, in its internal memory. The internal memory saves your pattern and song data even if the power is shut off. There are two song record modes: Step Record Mode and Real-time Record Mode.

■ Step Record Mode

In this mode you select patterns one at a time to create your song.



- 1 Press the **SONG** button to put the unit in Song Mode. Notice that the “SONG” indicator is flashing above the current Song Number.

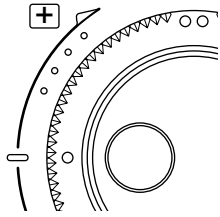
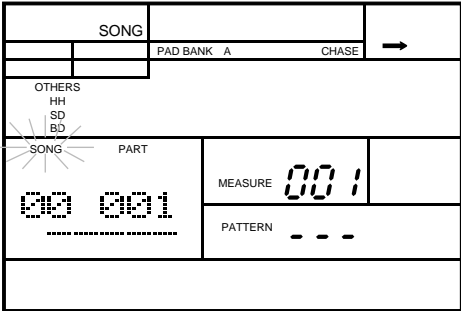

- 2 Select a song from “00” to “49” to record into by rotating the Jog Dial or by using the **+1** and **-1** buttons.

Song “50” is the demonstration song and cannot be edited. See page 12 for demonstration song playback.

WARNING

Be careful not to overwrite a song accidentally. If a song is empty, the “PATTERN” number is marked “---” indicating that there is no pattern data recorded. If the song position you want to use already has pattern data in it, you may want to clear the existing data before you start to record your new song. See page 77.

- 3** Start recording by pressing the **RECORD** button. The red Record LED lights and the “PATTERN” indicator flashes.

NOTE

The current Pattern is shown beside the flashing “PATTERN” indicator.

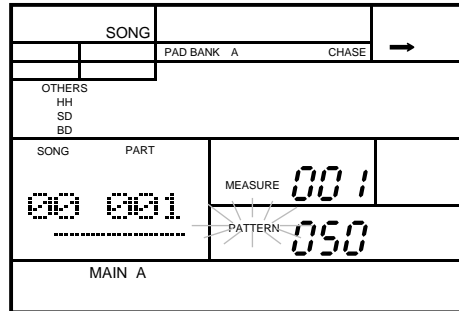
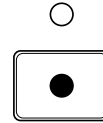

The following illustration points out some key indicators on the display when the RY20 is in Song Record Mode.

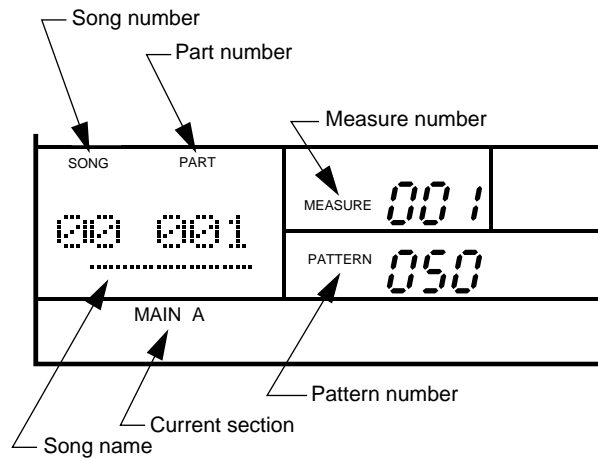

- 4** Select your first pattern by rotating the dial Jog Dial or by using the **+1** or **-1** buttons.

You can select any pattern from “000” to “149” to record into your song.

- 5** Select one of the six pattern sections. The default section is the last one selected in Pattern Mode, for example “MAIN A”.

Press and hold the **SECTION** button. Then press the Drum Pad button for the section you want to record, for example “INTRO”.

The selected section of the pattern is automatically recorded at the current part.

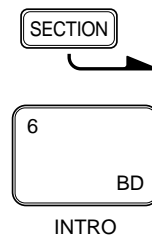



- 6** Press the **FORWARD** button to select the next part to record.

NOTE

The “PART” number and “MEASURE” number prompts both get updated.

SONG		PAD BANK A CHASE →	
OTHERS HH SD BD			
SONG	PART	MEASURE	
00	002	005	
PATTERN			
		050	
MAIN A			

Part numbers that exceed “999” will be displayed without the fourth digit, for example, part number 1001 will be displayed as “001”.

A measure number that exceeds “999” will also be displayed without the fourth digit. For example, measure number 1001 will be displayed as “001”.

- 7** Repeat the previous three steps to record the next part.

HINT

Most songs consist of an intro, a number of measures of verse and chorus, optionally a bridge, and an ending. The patterns of the RY20 follow this design.

For example, start your song off with an “INTRO” section. Then select the “MAIN A” section and record four parts. Record a single part of “FILL AB” and follow it with two parts of “MAIN B”, a single part of “FILL BA” to make the transition back. Record another four parts of “MAIN A”, then select “ENDING”.

- 8** Press the **FORWARD** button again.

NOTE

Again the “PART” number and “MEASURE” number prompts both get updated to reflect the length of the latest pattern.

- 9** Repeat steps 7 and 8 until you have completed your song.

NOTE

The **TOP**, **FORWARD**, and **BACKWARD** buttons can be used to move around the song so that you can edit the parts you have recorded.

You can also record the selected section of the current pattern by pressing the **ENTER** button. To record more than one part of a section, press the **ENTER** button repeatedly until you have recorded the number of parts desired.

Entering Fills

You can select the precise point at which to insert one of the transition sections, “FILL AB” or “FILL BA”.

- 1 Using the **FORWARD** or **BACKWARD** buttons, select the part (main section) that you want the transition to appear in.
- 2 While holding down the **SECTION** button, press the Drum Pad button for the transition section you want to play, for example the **9 - HH PEDAL** button to select “FILL AB”. The display changes as shown:

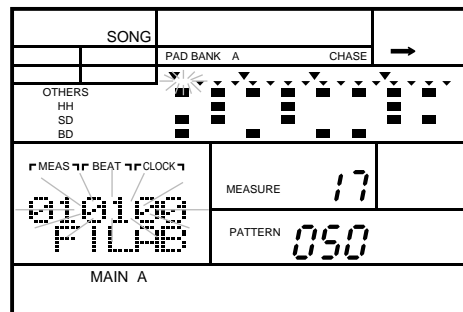

- 3 While still holding the **SECTION** button, rotate the Jog Dial or use the **+1** and **-1** buttons to select the precise point at which you want the transition or fill to replace the currently selected (main) section.

The “MEAS | BEAT | CLOCK” indicators initially show the top of the selected part. As you select the insert point, the indicators are updated to show the exact timing of the beginning of the fill. If you select an insert point which exceeds the number of measures of the selected part, the operation will be ignored.

Before you attempt to perform this operation, there must be a “MAIN A”, “MAIN B”, “INTRO”, or “ENDING” recorded in your song. If the current section is empty, this operation is not possible.

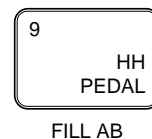

- 10 Stop recording by pressing the **RECORD** button again. The red Record LED turns off and the RY20 returns to Song Mode.

NOTE

If you have recorded a long and complex song, the RY20 may need a short time to arrange the data in its memory. In this case, the prompt "PLEASE WAIT" may momentarily appear on the display,

IMPORTANT

Depending on the amount of data you have recorded, it may not be possible to fully record all the available songs. If you run out of memory during recording, the error message "MEMORY FULL" will appear on the display. If this happens, use the Song Clear function described on page 77 to clear unwanted song data. The maximum memory capacity is approximately 4,000 parts.

You may also want to use a MIDI data storage device such as the Yamaha MDF2 MIDI Data Filer to save your important data to floppy disk.

WARNING

Turning the power off while Song Record Mode is active may cause the irretrievable loss of ALL user data.

Playing the Song

After you have recorded a song, you may want to check your work:

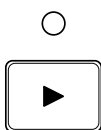

- 1 Press the **PLAY** button to start the song. The green Play LED will flash in time with the current tempo setting and the song will begin playback.

NOTE

You can change the tempo as the song plays. The RY20 always remembers the last tempo you entered for a song.

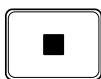

- 2 Press the **STOP** button to stop playing the song. The green Play LED stops flashing.

See page 73 for more details about playing a song.

Real-Time Record Mode

Recording a song in real-time mode allows you to listen to the patterns as you record them.

- 1 Select a song and start recording by pressing the **RECORD** button. The red Record LED lights and the “PATTERN” indicator flashes.

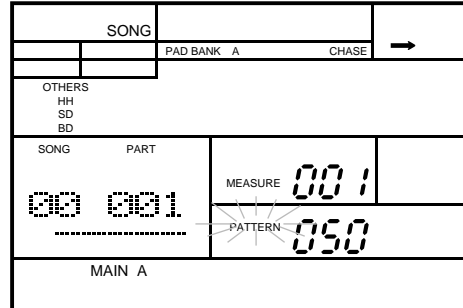

- 2 Select the first section for your song by holding down the **SECTION** button and pressing the Drum Pad button for the section you want to record.

Then select the first pattern by rotating the Jog Dial or by using the **+1** and **-1** buttons.

- 3 Press the **PLAY** button to start real-time recording. The green Play LED will flash in time with the current tempo setting, you will hear the click sounds, and the RY20 will count down two measures.

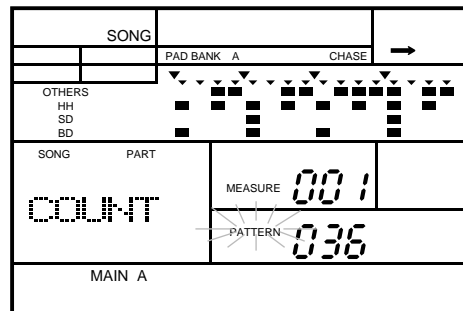

When the countdown has completed, the RY20 will start playing the first pattern. This pattern is recorded into the song.

NOTE

You can adjust both the volume level and the quantization of the click sound. Refer to page 72.

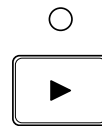
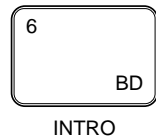
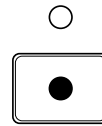

- 4** Select the next pattern by rotating the Jog Dial or by using the **[+1]** and **[-1]** buttons.

Alternatively, you can select another section. Press and hold the **[SECTION]** button. Then press the drum pad button for the next section you want to record.

The “NEXT” indicator lights up until the current pattern or section has finished playing.

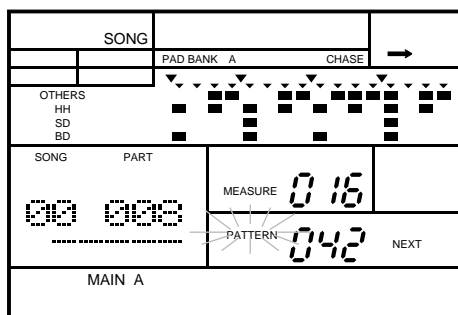

If the pattern or section you select is empty, the “EMPTY” indicator will also light up.

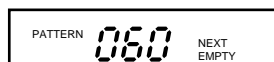

NOTE

If you selected the “INTRO” section, it will be recorded and automatically followed by “MAIN A”.

If you select one of the two transition sections, “FILL AB” or “FILL BA”, they will play (and be recorded) immediately. If the fill you select is “FILL AB”, it will be followed by “MAIN B”. If the fill you select is “FILL BA”, it will be followed by “MAIN A”. The fills behave the same as during pattern play. See page 16 for further details.

If you select the “ENDING” section, the RY20 will play (and record) it and stop real-time recording at the end of the section.

- 5** Repeat step 4 until you have recorded all the patterns and sections you want.



- 6** Press the **[STOP]** button to stop real-time recording. The green Play LED stops flashing. However, the RY20 is still in record mode, allowing you to continue adding to your song.

■ Setting the Tempo

Set the tempo for your new song.

- 1 Press the **TEMPO** button to place the unit in Tempo Mode. Adjust the tempo by rotating the Jog Dial or by using the **+1** and **-1** buttons.



The tempo can be set to any value from 40 to 250 beats per minute.

- 2 Press the **SONG** button to return back to Song Record Mode.

NOTE

Pressing the **TEMPO** button again is another method of switching the RY20 back to Song Record Mode.

■ Deleting a Part

- 1 In Song Record Mode, you can delete a part from the current song.

Select the Delete Part display page by pressing the **DELETE** **CLEAR** button. The “DEL” indicator is lit and the prompt “SURE?” is displayed.

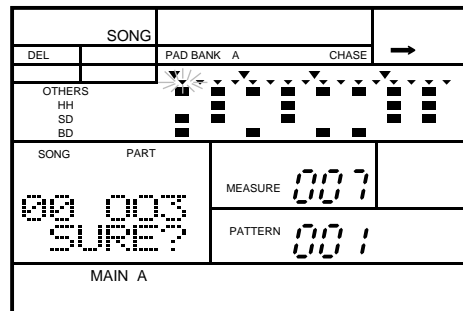

NOTE

You can also select this display page by pressing the **PAGE+** button.



- 2 Select the part to be removed by stepping through the parts with the **FORWARD** or **BACKWARD** button.





3 Press the **ENTER** button to delete the part.

WARNING

*BE CERTAIN THAT THIS IS WHAT YOU INTEND BEFORE YOU PRESS THE **ENTER** BUTTON.*

IMPORTANT

*If you decide that you **DO NOT** want to delete a part from the song, you can cancel this operation by simply selecting another function.*

Press the **SONG** button to return to Song Record Mode.

Press the **PAGE+** or **PAGE-** buttons to select another display page.

Cancel the recording by pressing the **RECORD** button.

4 Press the **PAGE-** button to return to Song Record Mode.

NOTE

If the selected part has no data, the message “PART EMPTY” will momentarily appear.

■ Inserting a Part

1 In Song Record Mode, you can insert a part into the current song.



Select the Insert Part display page by pressing the **INSERT COPY** button. The “INS” indicator is lit and the prompt “SURE?” is displayed.

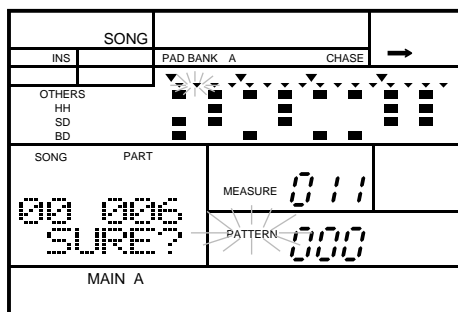

NOTE

You can also select this display page by pressing the **PAGE+** buttons.



- 2** Select the insert location by stepping through the parts with the **FORWARD** or **BACKWARD** button.



- 3** Select a pattern to insert by rotating the Jog Dial or by using the **+1** and **-1** buttons.

Alternatively, select another section to insert. Press and hold the **SECTION** button. Then press the drum pad button for the section you want to record.

- 4** Press the **ENTER** button to insert the part.

**NOTE**

The new part is inserted **BEFORE** the current part.

IMPORTANT

If you decide that you **DO NOT** want to insert a part into the song, you can cancel this operation by simply selecting another function.

Press the **SONG** button to return to Song Record Mode.

Press the **PAGE+** or **PAGE-** buttons to select another display page.

Cancel the recording by pressing the **RECORD** button.

NOTE

The error message “MEMORY FULL” may appear. For further details, refer to page 66.

- 5** Press the **PAGE-** button to return to Song Record Mode.

■ Adjusting the Click

The RY20 has a built-in click which you can use as a “count-in” in Real-time Record Mode. You can change both the volume and the quantization of the click sounds.



- 1 Select the Click display page by pressing the **PAGE+** button until the display indicates “CLICK”. Notice the current volume level flashing.

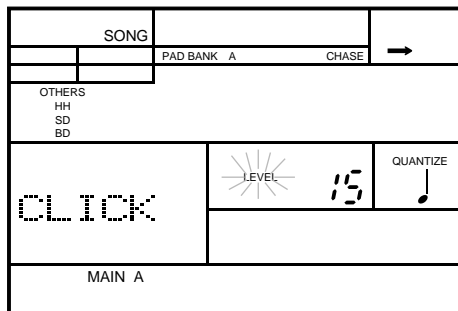

- 2 Set the volume by rotating the Jog Dial or using the **+1** and **-1** buttons.





The default volume is “15”. The range is from “00” to “15”.

NOTE

Pressing the **+1** and **-1** buttons simultaneously resets the level to “00”.

- 3 Set the quantization by using the **▶** cursor button to change the focus to the “QUANTIZE” prompt. Change the value by rotating the Jog Dial or using the **+1** and **-1** buttons.

The default quantization is quarter note. The quantization values are:

-  = quarter note.
-  = eighth note.
-  = eighth note triplet.
-  = 16th note.
-  = 16th note triplet.

NOTE

Changing the volume level or quantization in Song Record Mode also changes it in Pattern Record Mode.

8

Playing the Songs

■ Playing a Song

- 1** Press the **SONG** button to put the RY20 into Song Mode. Select the song you want to play by rotating the Jog Dial or using the **+1** and **-1** buttons.

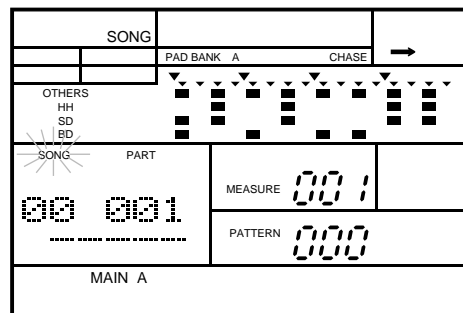

- 2** Press the **PLAY** button to start the song. The green Play LED will flash in time with the current tempo setting and the song will begin playback.

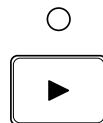

NOTE

You can change the tempo as the song plays. See page 19 for further details. Also see page 69 for recording an initial tempo for your song.

The RY20 always remembers the last tempo you entered for a song.

- 3** Press the **STOP** button to stop playing the song. The green Play LED stops flashing.



- 4** Press the **PLAY** button again to start the song from the point at which it was stopped.

NOTE

If you want to play the song from the beginning again, press the **TOP** button to reset the position. Then press the **PLAY** button to play the song again.



Selecting a Part

While the RY20 is stopped, you can select one of the parts of your song.



The **FORWARD** button steps forwards through the parts of the song. Each time you press the button, the RY20 moves to the next part.

Press the **PLAY** button to start playback from the selected part.

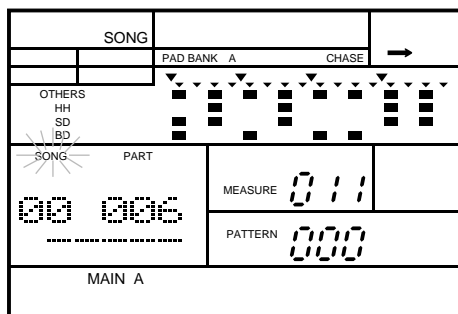

NOTE

The **BACKWARD** button steps backwards through the parts of the song.



Other Song Play Functions



You can use the **◀** and **▶** cursor buttons to select other focus areas in the Song Mode display page.

- 1 Select the “PART” prompt. This allows you to use the Jog Dial or the **+1** and **-1** buttons to change the part number. Then press the **PLAY** button to start playback from the selected part.

NOTE

This is an alternative method to using the **FORWARD** and **BACKWARD** buttons as shown above.

- 2 Select the “MEASURE” prompt. This allows you to select a measure within a song by rotating the Jog Dial or by using the **+1** and **-1** buttons.

Now you can start playback from the selected measure by pressing the **PLAY** button.

- 3 Select the “PATTERN” prompt. Change the current pattern by rotating the Jog Dial or by using the **+1** and **-1** buttons.

This allows you to temporarily change the pattern that is played by the current song.

NOTE

This pattern change is not recorded in memory.

■ Chain and Repeat

The RY20 has two convenient functions for playing songs: Chain and Repeat.

Repeat

Repeat causes the currently selected song to be played continuously.

1 Press the **SONG** button to put the RY20 into Song Mode.

2 Select the song you want to play by rotating the Jog Dial or using the **+1** and **-1** buttons.

3 Select the Repeat display page by pressing the **PAGE+** or **PAGE-** buttons. The display indicates "REPEAT".

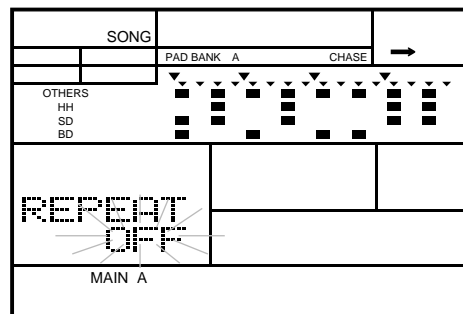

4 Change the value from "OFF" to "ON" by rotating the Jog Dial or using the **+1** and **-1** buttons.

Notice that the icon changes in the top right corner of the LCD panel.

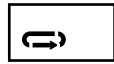

This indicates that the Repeat function is active.

NOTE

When Repeat is turned on, it applies to all the songs.

- 5** Cancel this mode by rotating the Jog Dial or using the **+1** and **-1** buttons.

Chain

Chain allows you to play all the songs in order. If the next song is empty, song play stops.

- 1** Press the **SONG** button to put the RY20 into Song Mode.
- 2** Select the song with which to start the chain playback by rotating the Jog Dial or using the **+1** and **-1** buttons.
- 3** Select the Chain display page by pressing the **PAGE+** or **PAGE-** buttons. The display indicates “CHAIN”.

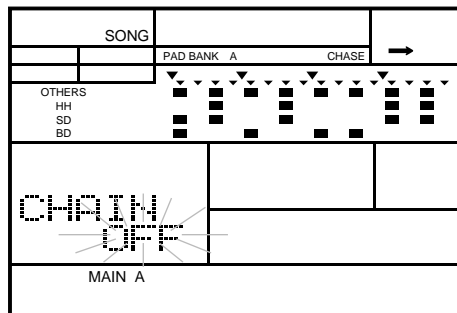

- 4** Change the value from “OFF” to “ON” by rotating the Jog Dial or using the **+1** and **-1** buttons.

Notice that the icon changes in the top right corner of the LCD panel.

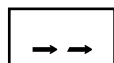

This indicates that the Chain function is active.

NOTE

When Chain is turned on, it applies to all the songs.

When you play the songs using the Chain function, the RY20 plays each song in order until it encounters a song with no data or until it finishes playing the last song.

- 5 Cancel this mode by rotating the Jog Dial or using the **+1** and **-1** buttons.

Repeat and Chain

You can combine the Repeat and Chain functions. This allows continuous playback of all the songs in order.

The icon in the top right corner of the LCD panel changes again.

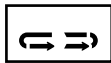

This indicates that both the repeat and chain functions are selected and active.

■ **Clearing a Song**

This function is used to remove all the song data from a song.

- 1 Press the **SONG** button to put the RY20 into Song Mode.
- 2 Select the Clear display page by pressing the **DELETE CLEAR** button. The display reads “CLEAR SURE?”. Notice that the “SONG” prompt is flashing beside the currently selected song number.

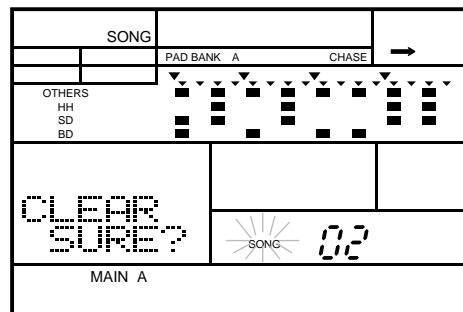

NOTE

You can also get to this display page by pressing the **PAGE+** or **PAGE-** buttons.

- 3** Select a song to clear by rotating the Jog Dial or using the **+1** and **-1** buttons.



- 4** Clear the song by pressing the **ENTER** button. The “END” prompt will momentarily appear on the LCD.

IMPORTANT

If you decide that you **DO NOT** want to clear the song, you can cancel this operation by simply selecting another function. There are several ways to do this:

Press the **SONG** button to return to Song Mode.

Press the **PAGE+** or **PAGE-** buttons to select another display page.

NOTE

If the selected song contains a lot of data, you may see the prompt “PLEASE WAIT” as the RY20 clears the data.

WARNING

When you press the **ENTER** button the clear operation will be performed. It is not possible to recover data that you have lost by clearing or overwriting the song.

BE CERTAIN THAT THIS IS WHAT YOU INTEND TO DO.

NOTE

Clearing a song **DOES NOT** clear the pattern data from the patterns that were included in the song. To clear the pattern data, refer to page 55.

WARNING

Turning the power off while clearing a song may cause the irretrievable loss of **ALL** user data.

■ Copying a Song

You can copy the data from any song to another song number.

- 1 Press the **SONG** button to put the RY20 into Song Mode. Select a song to copy from by rotating the Jog Dial or using the **+1** and **-1** buttons.

The song you just selected is the Source Song.

- 2 Select the Copy display page by pressing the INSERT **COPY** button. The display reads “COPY SURE?”.

INSERT **COPY**

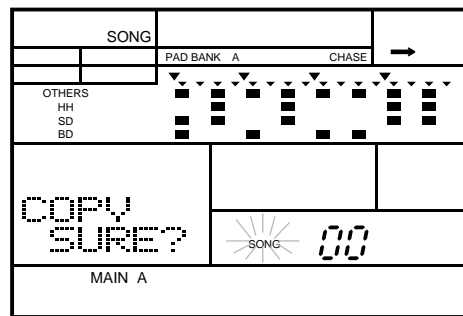

NOTE

You can also get to this display page by pressing the **PAGE+** or **PAGE-** buttons.

- 3 Select the song to copy to by rotating the Jog Dial or using the **+1** and **-1** buttons.

The song you just selected is the Destination Song. You must select a song from “00” to “49” as your destination song.

WARNING

Be careful not to overwrite a song accidentally. The “EMPTY” indicator will light for songs that contain no data. If the destination pattern you have selected already contains data, the copy function will replace that data.

- 4 Copy the song by pressing the **ENTER** button. The “END” prompt will momentarily appear on the LCD.

IMPORTANT

If you decide that you DO NOT want to copy a song, you can cancel this operation by simply selecting another function. There are several ways to do this:

*Press the **SONG** button to return to Song Mode.*

*Press the **PAGE+** or **PAGE-** buttons to select another display page.*

NOTE

If the source song contains a lot of data, you may see the prompt “PLEASE WAIT” as the RY20 copies the data to the destination song.

NOTE

The message “MEMORY FULL” may appear on the display. See the important message on page 66 for further details.

WARNING

*When you press the **ENTER** button the copy operation will be performed. It is not possible to recover data that you have lost by overwriting the song.*

BE CERTAIN THAT THIS IS WHAT YOU INTEND TO DO.

WARNING

Turning the power off during execution of the copy function may cause the irretrievable loss of ALL user data.

■ Name that Song

This mode allows you to assign a name of up to five characters to a song.

- 1 Press the **[SONG]** button to put the RY20 into Song Mode. Select a song by rotating the Jog Dial or using the **[+1]** and **[-1]** buttons.
- 2 Select the Name display page by pressing the **[PAGE+]** button until the display reads “NAME” and shows the name of the current song. Notice that the first character is flashing.

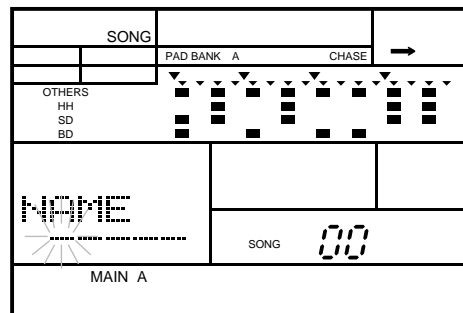

The default name for all songs is “-----”.

- 3 Select the first character of the name by rotating the Jog Dial or by using the **[+1]** and **[-1]** buttons.

NOTE

The RY20 contains the following character set, allowing you to use numbers, upper and lower case letters and symbols for your name.

(Space)

!"#%&'()*+,-./0123456789:;<=>?@ABCDEFGHIJKLMNPOQRSTUVWXYZ[\]^_`abcdefghijklmnopqrstuvwxyz{|}~<->

- 4 To move to the next character, press the **[▶]** button. The second character will flash. Change that character by rotating the Jog Dial or by using the **[+1]** and **[-1]** buttons.
- 5 Repeat the previous step until you have finished creating the name for your song.

9

Modifying the Drum Kits

The RY20 contains 300 realistic tunable voices including drums, effected drums, percussion of all kinds, and basses.

You will find a detailed description of the layout of the drum kits on the RY20 in the section “Playing the Pads” starting on page 21.

The RY20 has 20 preset drum kits and 20 user drum kits. Each drum kit has five drum pad banks and a bass pad bank. Each drum pad bank has a set of 12 pads, which means each drum kit has 60 drum voice locations. The bass pad bank has a five-octave range bass or pitched voice. This means that each kit has a 60-key keyboard.

The user drum kits “20” to “39” initially contain the same data as the preset drum kits “00” to “20” respectively.

IMPORTANT

When you attempt to change the voice assignment or any of the parameters of the preset drum kits, numbered “00” to “19”, the message “PRESET” will momentarily appear on the display. You cannot modify any of the parameters or voice assignments for a preset drum kit.

However, the Pad Sensitivity and Chase functions affect the entire system. You can also copy one of the kits to a user kit. You can then modify all the settings in the user location.

IMPORTANT

Please be aware that the parameter changes you make for Volume Level, Stereo Pan, Pitch, Decay, the Sensitivity modes, Voice Polyphony, and Alternate Group are assigned to each pad, NOT to each voice. Therefore, when you change the voice assignment to a pad, the current parameter settings are still active for the newly selected voice.

■ Assigning Voices to Each Pad

The first step in defining a drum kit is to assign voices to the drum pads.

Select a User Drum Kit

- 1 Place the RY20 in Drum Kit Mode by pressing the **DRUM KIT** button. Note that the “DRUM KIT” indicator at the top of the display is lit.

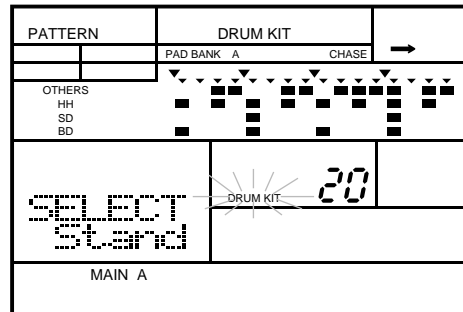

NOTE

From the initial display page of Drum Kit Mode, pressing the **DRUM KIT** button will switch the RY20 back to the previously selected main mode, such as Pattern or Song Play Mode or one of the recording modes.

From the other display pages of Drum Kit Mode, pressing the **DRUM KIT** button will switch to the mode's initial display page.

- 2 Select a user drum kit from “20” to “39” by rotating the Jog Dial or by using the **+1** and **-1** buttons.

NOTE

Use one of the user locations from “20” to “39” to create your own customized drum kit. As shipped from the factory, the user drum kits contain the same data as the drum kits “00” to “19”.

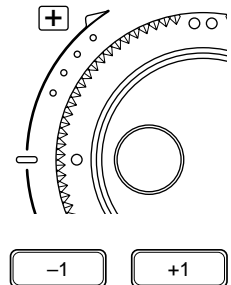

Select a Pad Bank



- 1 Press the **PAD BANK** button to switch the RY20 to Pad Bank Mode.

NOTE

From the initial display page of Pad Bank Mode, pressing the **PAD BANK** button will switch the RY20 back to the previously selected main mode, such as Pattern or Song Play Mode or one of the recording modes.

- 2 Select a Pad Bank from “A” to “E” by rotating the Jog Dial or by using the **+1** and **-1** buttons.

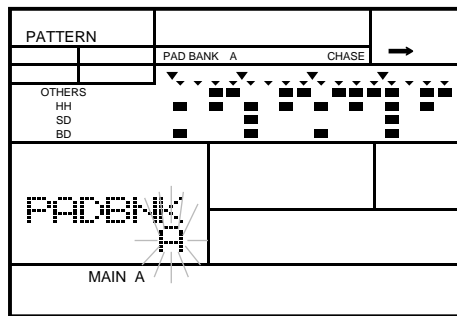

NOTE

The selected Pad Bank indicator will be shown at the top of the display.

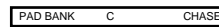

You can also select the Bass Pad Bank. With the RY20 in Pad Bank Mode, press the **PAGE+** button to access the Type display page. Change the type from “DRUM” to “BASS” by rotating the Jog Dial or by using the **+1** and **-1** buttons.

NOTE

When you switch the RY20 to “BASS”, the Pad Bank indicator also changes.



Press the **PAGE-** button to select the octave. The display shows the current octave range. Select an octave range from “OCT-2” to “OCT+2” by rotating the Jog Dial or by using the **+1** and **-1** buttons.

IMPORTANT

If you change any of the following drum kit parameters on a drum pad, it is changed for all the pads in the Bass Pad Bank.

Assigning Voices

- 1** Press the **DRUM KIT** button to return to Drum Kit Mode.



- 2** Select the Assign display page by pressing the **PAGE+** or **PAGE-** buttons. Notice that the voice assignment for the current drum pad is flashing.

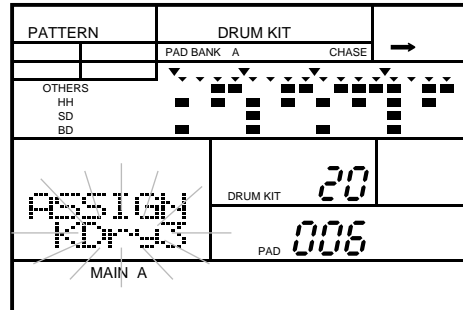

- 3** Press the drum pad you want to modify. The pad number on the display changes to the new drum pad. The voice assignment for that pad is also shown on the display.

- 4** Select a voice from the 300 available to assign to the current pad by rotating the Jog Dial or by using the **+1** and **-1** buttons.

HINT

You can also select a drum pad by changing the focus area.

Press the **▶** cursor button until the “PAD” indicator starts flashing, select another pad with the Jog Dial or by using the **+1** and **-1** buttons, then press the **◀** cursor button until the focus has returned to the voice assignment.



- 5** Complete your drum kit by repeating the steps shown above with the other drum pads. When you have finished assigning voices to the current Pad Bank of your Drum Kit, select another Pad Bank and continue assigning voices.

NOTE

You can assign any of the 300 voices of the RY20 to any drum pad. If you have selected the Bass Pad Bank, the voice will act as a “pitched” voice. However, some of the voices may not produce a distinguishable effect. You can only select ONE voice for all the drum pads in the Bass Pad Bank.

- 6** Press the **PAGE-** button to return to Drum Kit Mode.

HINT

A quick way to return to the main level in any mode is to simply press its function button again. For example, to return to Drum Kit Mode from one of its display pages, just press the **DRUM KIT** button.

■ **Volume Level**

Set the volume level for a drum pad.



- 1 Select the Level display page by pressing the **PAGE+** or **PAGE-** button. The display reads “LEVEL” and the current level flashes.

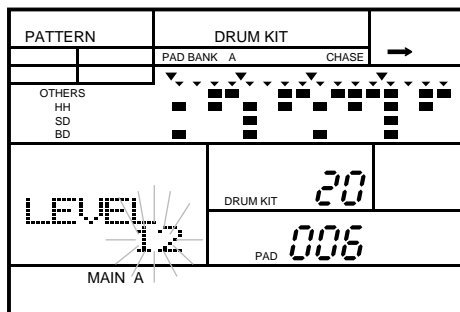

- 2 Press the pad you want to modify after selecting the Pad Bank.
- 3 Adjust the level of the pad by rotating the Jog Dial or by using the **+1** and **-1** buttons.

The volume level setting ranges from “00” to “15”. As you adjust the level, tap the pad to listen to the level changes.

Pressing the **+1** and **-1** buttons simultaneously resets the level to “15”.

NOTE

Each pad in your drum kit can be set with a different level setting unless you have selected the Bass Pad Bank. The bass or pitched voice is assigned one level for the entire bank.



You can use the **◀** and **▶** cursor buttons to access the “LEVEL”, “DRUM KIT” and “PAD” settings.

■ Stereo Pan

Define the stereo pan for a drum pad.

- 1 Select the Pan display page by pressing the **PAGE+** or **PAGE-** buttons . The display reads “PAN” and the current pan setting flashes.

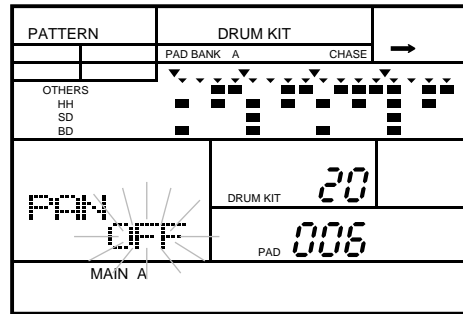

- 2 Press the pad you want to modify after selecting the Pad Bank.
- 3 Set the pan for the selected pad by rotating the Jog Dial or by using the **+1** and **-1** buttons.

The pan setting can be “OFF” or range from “-7” (extreme left) to “+7” (extreme right). A setting of “+7” results in the output of the selected voice coming from the right channel only, while a setting of “-7” pans fully left. A setting of “0” is stereo centre.

NOTE

Even though a voice is panned fully to one channel, you may still hear that voice in the other channel due to the effects processing performed by the built-in DSP.

All drum voices have a pre-assigned pan. Selecting “OFF” uses that value. Pressing the **+1** and **-1** buttons simultaneously resets the pan to the “OFF” setting.



NOTE

Each pad in your drum kit can be set with a different pan setting unless you have selected the Bass Pad Bank. The bass or pitched voice is assigned one pan for the entire bank.

You can use the **◀** and **▶** cursor buttons to access the “PAN”, “DRUM KIT” and “PAD” settings.



■ Pitch

The RY20 can adjust the pitch of its voices over a range of four octaves, two octaves above and two below the centre frequency.



- 1 Select the Pitch display page by pressing the **PAGE+** or **PAGE-** buttons. The display reads “PITCH” and the current pitch flashes.

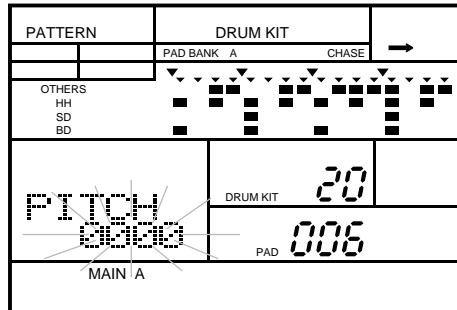

- 2 Press the pad you want to modify after selecting the Pad Bank.
- 3 Adjust the pitch of the pad by rotating the Jog Dial or by using the **+1** and **-1** buttons.

You can adjust the pitch from “-2400” cents (minus two octaves) to “+2400” cents (plus two octaves) in increments of 10 cents (100 cents = 1 semitone).

NOTE

Some of the voices may not produce an audible effect.



Pressing the **+1** and **-1** buttons simultaneously resets the pitch to “0000”.

NOTE

If you have selected the Bass Pad Bank, you assign the pitch change for the entire bank. Each pad still plays a different pitch, but the pitch of all the pads is shifted by the adjusted setting.



You can use the **◀** and **▶** cursor buttons to access the “PITCH”, “DRUM KIT” and “PAD” settings.

Decay

The decay setting is used to modify voices, such as cymbals, that have a longer decay.

- 1 Select the Decay display page by pressing the **PAGE+** or **PAGE-** buttons. The display reads “DECAY” and the current value flashes.

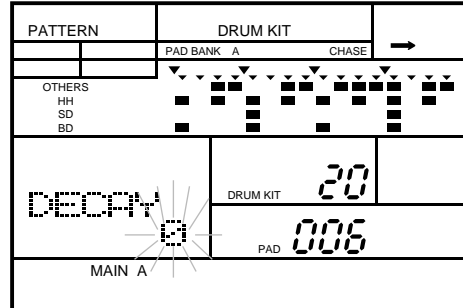

- 2 Press the pad you want to modify after selecting the Pad Bank.
- 3 Adjust the decay of the pad by rotating the Jog Dial or by using the **+1** and **-1** buttons.

The range is from “+7” to “-7”.

NOTE

Some of the voices may not produce an audible effect.

Pressing the **+1** and **-1** buttons simultaneously resets the decay to “0”.



NOTE

If you have selected the Bass Pad Bank, the decay setting applies to all the pads.

You can use the **◀** and **▶** cursor buttons to access the “DECAY”, “DRUM KIT” and “PAD” settings.



■ Sensitivities

The RY20 allows you to set four sensitivity parameters. These parameters determine the effect of tapping a drum pad harder (with increasing velocity) on the output sound.

NOTE

Some of the voices may not produce an audible effect.

Level Sensitivity

The harder you tap a drum pad, the louder its voice will sound.



- 1 Select the Level Sensitivity parameter by pressing the **PAGE+** or **PAGE-** button. The display reads “SENS” and “LVL”. The current level flashes.

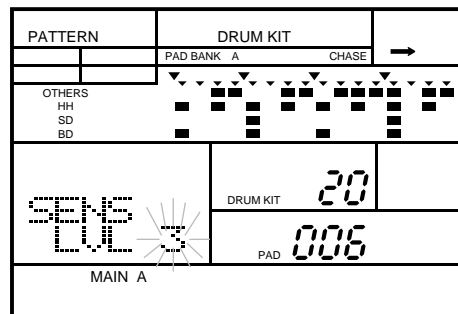

- 2 Press the pad you want to modify after selecting the Pad Bank.
- 3 Adjust the level sensitivity of the drum pad by rotating the Jog Dial or by using the **+1** and **-1** buttons.

The range is from “0” to “3”. Depending on the Pad Sensitivity setting (see page 98), adjusting this setting affects how loud a voice will sound the harder you tap its corresponding drum pad.

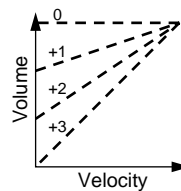

When the level sensitivity is set to a value of “0”, an increase in velocity will not change the volume.

Pressing the **+1** and **-1** buttons simultaneously resets the level sensitivity to “3”.



NOTE

If you have selected the Bass Pad Bank, the level sensitivity setting applies to all the pads.

You can use the **◀** and **▶** cursor buttons to access the “SENS LVL”, “DRUM KIT” and “PAD” settings.



Pitch Sensitivity

This parameter controls how much the pitch of a voice will shift as the velocity with which you tap its drum pad increases.

- 1 Select the Pitch Sensitivity parameter by pressing the **PAGE+** or **PAGE-** button. The display reads “SENS” and “PCH”.

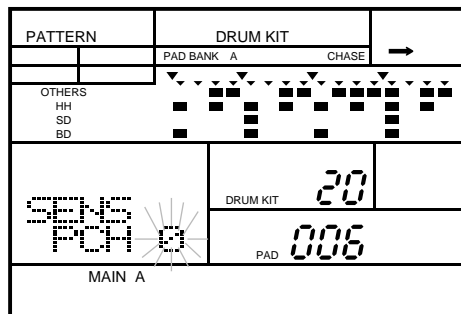

- 2 Press the pad you want to modify after selecting the Pad Bank.
- 3 Adjust the pitch sensitivity of the pad by rotating the Jog Dial or by using the **+1** and **-1** buttons.

The range is from “0” to “3”. Depending on the Pad Sensitivity setting (see page 98), adjusting this setting changes how much the pitch of a voice will shift up as the velocity with which you tap the drum pad increases.

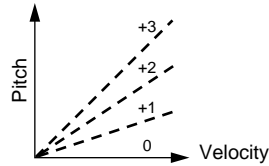

Pressing the **+1** and **-1** buttons simultaneously resets the pitch sensitivity to “0”.

NOTE

If you have selected the Bass Pad Bank, the pitch sensitivity setting applies to all the pads.



You can use the **◀** and **▶** cursor buttons to access the “SENS PCH”, “DRUM KIT” and “PAD” settings.

Decay Sensitivity

The decay of a voice can also be modified by the velocity of the drum pad tap.



- 1 Select the Decay Sensitivity parameter by pressing the **PAGE+** or **PAGE-** buttons. The display reads “SENS” and “DCY”.

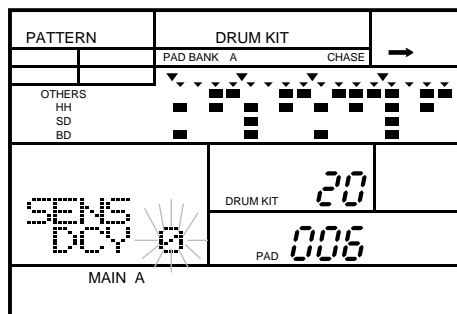

- 2 Press the pad you want to modify after selecting the Pad Bank.
- 3 Adjust the decay sensitivity of the voice by rotating the Jog Dial or by using the **+1** and **-1** buttons.

The range is from “+3” to “-3”. Depending on the Decay (see page 89) and Pad Sensitivity (see page 98) settings, adjusting this setting affects the way the decay changes as the velocity with which you tap the drum pad changes.

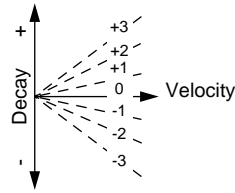

Pressing the **[+1]** and **[-1]** buttons simultaneously resets the decay sensitivity to “0”.



NOTE

If you have selected the Bass Pad Bank, the decay sensitivity setting applies to all the pads.

You can use the **[◀]** and **[▶]** cursor buttons to access the “SENS DCY”, “DRUM KIT” and “PAD” settings.



Balance Sensitivity

Some of the voices of the RY20 are two-layered. For example, a snare drum will have both a center snare and a rim shot voice. The balance sensitivity controls how much of the second sound is heard as the pad is tapped harder.

- 1 Select the Balance Sensitivity parameter by pressing the **[PAGE+]** or **[PAGE-]** buttons. The display reads “SENS” and “BAL” and the current balance flashes.

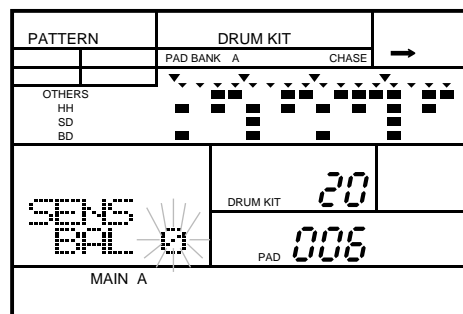

- 2 Press the pad you want to modify after selecting the Pad Bank.
- 3 Adjust the balance sensitivity of the voice by rotating the Jog Dial or by using the **+1** and **-1** buttons.

The range is from “+3” to “-3”. Depending on the setting of the Pad Sensitivity (see page 98), this setting affects the balance of the voice, as the pad is tapped harder.

The following diagram illustrates the effects of the different settings on two-element voices.

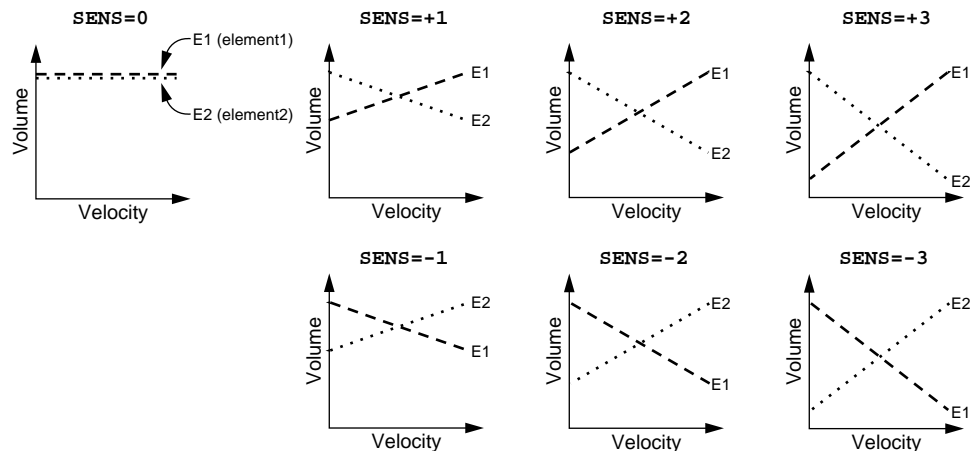

NOTE

If the balance sensitivity setting is not applicable to the voice currently assigned to the pad, the display shows “--” to indicate that this parameter cannot be changed.



Pressing the **+1** and **-1** buttons simultaneously resets the balance sensitivity to “0”.

NOTE

If you have selected the Bass Pad Bank, the balance sensitivity setting applies to all the pads.



You can use the **◀** and **▶** cursor buttons to access the “SENS BAL”, “DRUM KIT” and “PAD” settings.

■ Voice Polyphony

When voice polyphony is on, the voice continues to play, even if you have triggered two events consecutively. This allows you to play voices with a long decay, such as crash cymbals, without cutting off the tail end of the previous cymbal sound.

- 1 To adjust the polyphony of the drum pad, select the Polyphonic display page by pressing the **PAGE+** or **PAGE-** button. The display reads “POLY”.

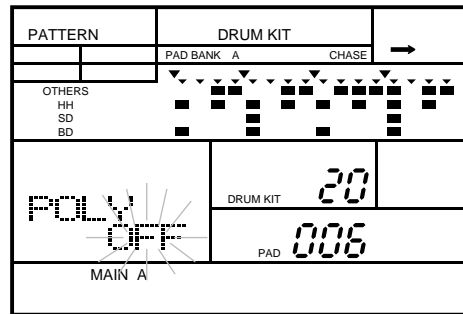

- 2 Press the pad you want to modify after selecting the Pad Bank.
- 3 The voice polyphony of the drum pad is either “OFF” or “ON”. Set the value by rotating the Jog Dial or by using the **+1** and **-1** buttons.

NOTE

This mode applies to the individual voices, not the overall instrument.

The voice polyphony setting applies to all the pads if you selected the Bass Pad Bank.

You can use the **◀** and **▶** cursor buttons to access the “POLY”, “DRUM KIT” and “PAD” settings.



■ Alternate Group

You can assign individual voices to a group. This function is similar to turning polyphony off, except in this case the effect is used with interacting voices. For example, you can use the alternate group to create a more realistic effect with the various hi-hat voices in your kit.



- 1 Select the Alternate Group display page by pressing the **PAGE+** or **PAGE-** buttons. The display reads “ALTER” and the current group flashes.

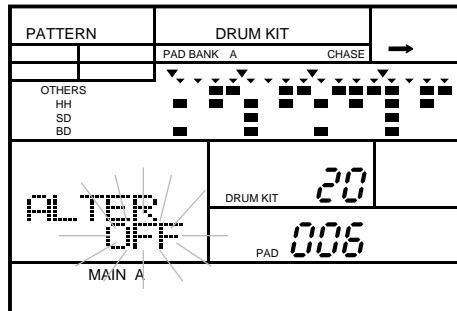

- 2 Press the pad you want to modify after selecting the Pad Bank.
- 3 Select a group by rotating the Jog Dial or by using the **+1** and **-1** buttons.

You have seven groups to choose from. The range is “OFF” or from “1” to “7”. Pressing the **+1** and **-1** buttons simultaneously resets the setting to “OFF”.

NOTE

In a real drum set, you would never hear the sound of a closed hi-hat at the same time as an open hi-hat. If you assign both of these instruments to one of the available alternate groups, the closed and open hi-hat sounds will not sound together, even if you play the pads at the same time. This means you can play the open hi-hat, then “close” the hi-hat by playing the closed hi-hat pad.

The RY20 has individual voices for each hi-hat sound. To achieve a realistic effect, group the three hi-hat pads together into an alternate group.



You can use the **◀** and **▶** cursor buttons to access the “ALTER”, “DRUM KIT” and “PAD” settings.

Note/Trigger Driven

You can set each drum pad to receive Note-Off information. Once “NOTE” Driven is selected, its sound is cut immediately when you release the pad or when the internal sequencer or an external MIDI device sends a Note Off message.

- 1 Select the Note Driven display page by pressing the **PAGE+** or **PAGE-** button. The display reads “DRIVEN” and the current status flashes.

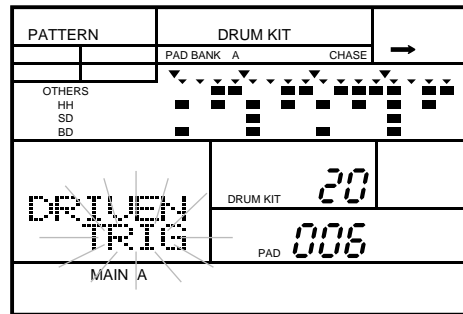

- 2 Press the pad you want to modify after selecting the Pad Bank.
- 3 The Note Driven value of a drum pad is either “TRIG” or “NOTE”. Select a value by rotating the Jog Dial or by using the **+1** and **-1** buttons.

When the Note-Off is received, the sound is cut off immediately.

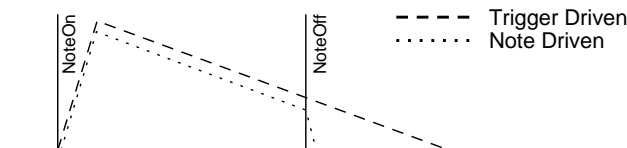

NOTE

If the Driven setting is not applicable to the voice currently assigned to the pad, the display shows “-----” to indicate that this parameter cannot be changed. In this case, the voice is fixed to the Note Driven setting. Refer to the Voice List shown on page 124

You can use the **◀** and **▶** cursor buttons to access the “DRIVEN”, “DRUM KIT” and “PAD” settings.



■ Pad Sensitivity

You can modify the velocity response of the pads with the pad sensitivity function. Unlike the preceding parameters, this setting affects the entire system.



- 1 Select the Pad Sensitivity display page by pressing the **PAGE+** or **PAGE-** button. The display indicates “PADSNS” and the current curve flashes.

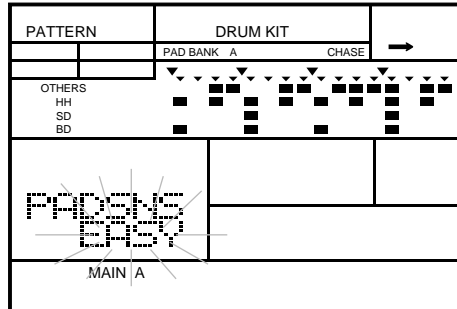

- 2 Select the pad sensitivity by rotating the Jog Dial or by using the **+1** and **-1** buttons.

The RY20 has four pad sensitivity settings: “EASY”, “LINER” (Linear), “HARD”, and “CONST” (Constant):

- **EASY** sets the drum pads to the most sensitive level. You do not have to tap very hard to get a louder sound.
- **LINER** is a linear setting.
- **HARD** requires you to tap the drum pads firmly in order to get a louder sound.
- **CONST** (Constant) turns off velocity sensitivity.

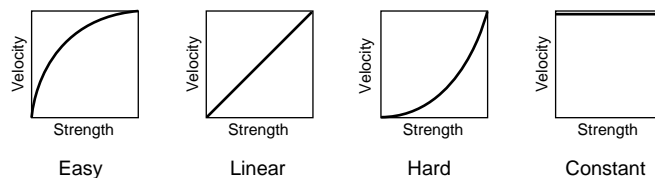

The velocity setting affects every pad in all the drum kits.

■ Chase

The Chase function controls whether the RY20 uses the currently selected Drum Kit or the Drum Kit that was used to record the pattern, to play back a pattern. Like the Pad Sensitivity, the Chase function affects the entire system.

- 1 Select the Chase display page by pressing the **PAGE+** or **PAGE-** button. The display indicates “CHASE”. The current mode flashes.

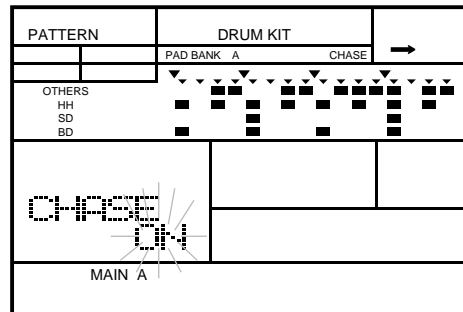

- 2 The chase mode is either “ON” (the default) or “OFF”. Change the mode by rotating the Jog Dial or by using the **+1** and **-1** buttons.

When you turn the chase mode off, notice that the “CHASE” indicator on the “PAD BANK” row also switches off.

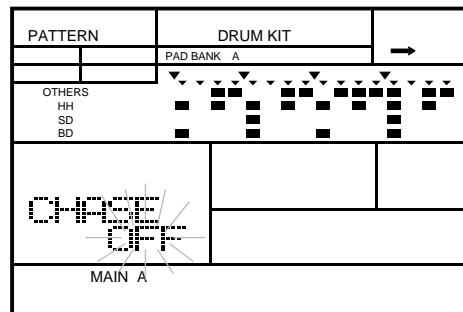

■ Copy

This function lets you copy the current drum kit to another user kit.



- 1 Place the unit in Drum Kit Mode by pressing the **DRUM KIT** button. Select the drum kit to copy from by rotating the Jog Dial or by using the **+1** and **-1** buttons.

The kit you just selected is the Source Kit.



- 2 Select the Copy display page by pressing the **PAGE+** or **PAGE-** buttons until the display reads “COPY SURE?”. Notice that the “DRUM KIT” indicator is flashing.

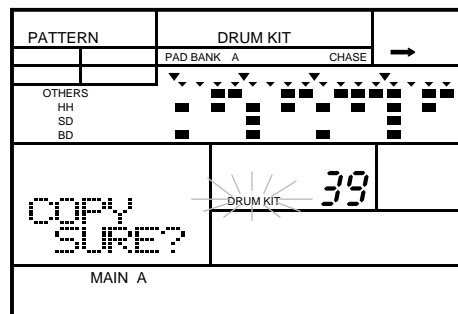

- 3 Select a drum kit from “20” to “39” to copy to by rotating the Jog Dial or by using the **+1** and **-1** buttons.

The kit you just selected is the Destination Kit.

NOTE

You can only copy to the user drum kits “20” to “39”.

You CANNOT use the **COPY** button in this case.

If you want to exit this operation without performing the copy, press the **DRUM KIT** button or select another display page with the **PAGE+** or **PAGE-** button.



To initiate the copy, press the **ENTER** button. The “END” prompt will momentarily appear on the display when the copy has finished.

WARNING

When you press the **ENTER** button, the copy operation will be performed. It is not possible to recover data that you have lost.

■ Name

The name function allows you to assign a five character name to the drum kit you have just modified.

- 1 Place the unit in Drum Kit Mode by pressing the **DRUM KIT** button. Select a drum kit by rotating the Jog Dial or by using the **+1** and **-1** buttons.



- 2 Select the Name display page by pressing the **PAGE+** button until the display reads "NAME" and displays the name of the current drum kit. Notice that the first character is flashing.

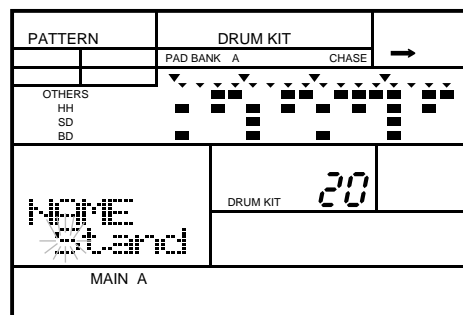

- 3 Select the first character of the name by rotating the Jog Dial or by using the **+1** and **-1** buttons.

NOTE

The RY20 contains the following character set, allowing you to use numbers, upper and lower case letters and symbols for your name.

(Space)

□ ! " # \$ % & ' () * + , - . / 0 1 2 3 4 5 6 7 8 9 : ; < = > ? @ A B C D E F G H I J K L M N O P Q R S T U V W X Y Z [\] ^ _ ` a b c d e f g h i j k l m n o p q r s t u v w x y z { | } → ←

- 4 To move to the next character, press the **▶** cursor button. The second character will flash. Change that character by rotating the Jog Dial or by using the **+1** and **-1** buttons.



- 5 Repeat the previous step until you have finished creating your drum kit name.

10

Changing the Effects

The RY20 contains a built-in DSP that is capable of a wide variety of reverb and delay effects.

■ Enabling Effects

If you have a rack of reverbs, delays, and other effects devices, you may want to use just the drum sounds of the RY20. The first display page of the Effect Mode allows you to quickly and conveniently bypass the DSP effects, switching from a “wet” sound to a “dry” sound.



- 1 Put the RY20 in Effect Mode by pressing the **EFFECT** button. Notice that the “EFFECT” indicator is switched on as is the “EFFECT” prompt and that the current setting is flashing.

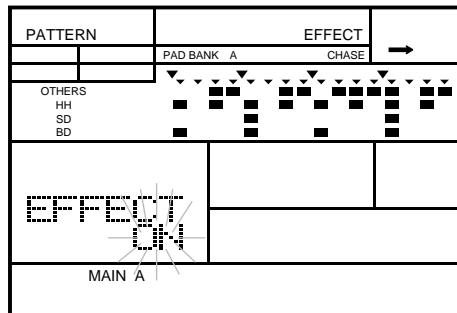

NOTE

From the initial display page of the Effect Mode, pressing the **EFFECT** button will switch the RY20 back to the previously selected main mode, such as Pattern or Song Play Mode or one of the recording modes.

From the other display pages of the Effect Mode, pressing the **EFFECT** button will switch to the initial display page of the mode.

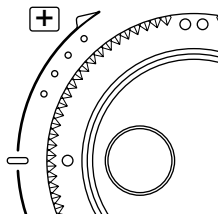

- 2 Switch from effect “ON” to effect “BYPAS” (bypass) by rotating the Jog Dial or by using the **+1** and **-1** buttons.



The RY20 is shipped with the Effect Mode “ON”. This setting applies to all the Drum Kits.

■ Select the Effect Type

The RY20 provides you with 10 different types of effect. You can apply a different effect to each drum kit. However, any changes you make to the effect settings for the preset drum kits are temporary. (The preset drum kits have predefined effect settings)

- 1 Select the Type display page by pressing the **PAGE+** or **PAGE-** button. The current effect flashes under the “TYPE” prompt.

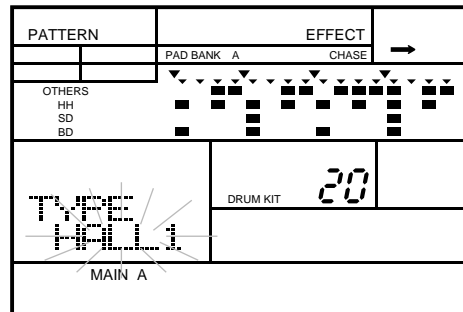

- 2 Set the desired type by rotating the Jog Dial or by using the **+1** and **-1** buttons.

The effect types are:

- | | | |
|---------------|---|---|
| Reverb | { | HALL1 A midsize concert hall. |
| | | HALL2 A large concert hall. |
| | | ROOM1 A large room. |
| | | ROOM2 A small room. |
| | | PLAT1 A rapidly attenuating plate reverb. |
| | | PLAT2 A rigid plate echo. |
| Delay | { | DELY1 A stereo delay with the delay and reverb connected in parallel. |
| | | DELY2 A stereo delay with the delay and reverb connected in series. |
| | | DELY3 A stereo delay with the delay and reverb connected in parallel. The delay time is synchronized to the tempo. |
| | | DELY4 A stereo delay with the delay and reverb connected in series. The delay time is synchronized to the tempo. |

■ Send Level

The send level is the amount of signal being sent to the DSP for processing. It is set for each individual drum pad.



- 1 Select the Send Level display page by pressing the **PAGE+** or **PAGE-** button. The current level flashes under the “SNDLVL” prompt.

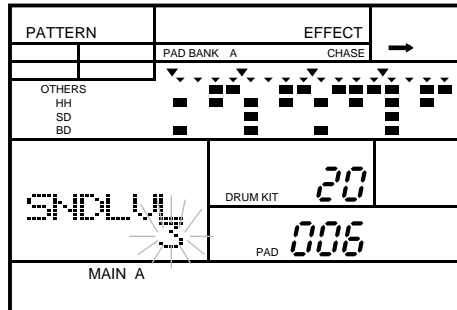

- 2 Press the pad you want to modify.

HINT



You can also select another drum kit or pad by changing the focus area with the **▶** cursor button, then selecting a drum kit or pad by rotating the Jog Dial or by using the **+1** and **-1** buttons.

- 3 Set the send level by rotating the Jog Dial or by using the **+1** and **-1** buttons.

The range is from “0” to “7”.

A level of “7” is the maximum signal level and a level of “0” sends no signal to the DSP.

NOTE

You can change the Send Level for the individual pads of the preset drum kits. Your altered settings will stay in effect until you select another drum kit.

Return Level

The return level is the amount of processed effect from the DSP.

- 1 Select the Return Level display page by pressing the **PAGE+** or **PAGE-** button. The current level flashes under the “RTNLVL” prompt.

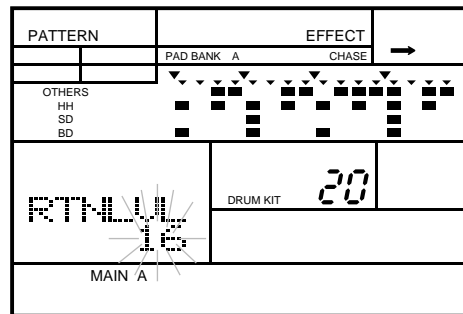

- 2 Set the return level by rotating the Jog Dial or by using the **+1** and **-1** buttons.

The range is from “00” to “31”. A level of “31” is the maximum signal level and a level of “00” turns off the parameter.

HINT

Judicious use of the return level will give you a reasonably clean sound. A high return level generates a lot of reflected sound.

NOTE

You can change the Return Level for the preset drum kits. Your altered setting will stay in effect until you select another drum kit.

■ Reverb Time

The reverb time is the amount of time it takes for the reverberation simulation to completely subside.



- 1 Select the Reverb Time display page by pressing the **PAGE+** or **PAGE-** button. The current level flashes under the “R.TIME” prompt.

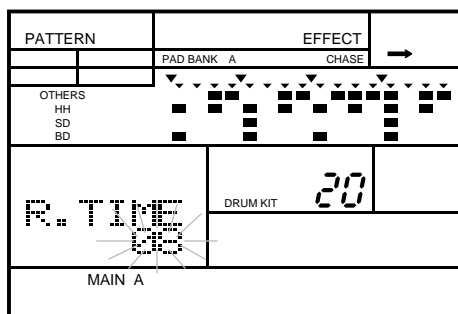

- 2 Set the reverb time by rotating the Jog Dial or by using the **+1** and **-1** buttons. The range is from “00” to “31”.

NOTE

With a setting at or near “00”, the reverberation ends quickly, giving you an artificial, metallic effect. Using a higher setting, for example at or near “31”, causes the reverberation to go on for a long time.

You can change the Reverb Time for the preset drum kits. Your altered setting will stay in effect until you select another drum kit.

Feedback Gain

This setting affects the amount of delay signal being fed back to the DSP. The higher the value you select, the greater the number of delayed repeats is produced.

- 1** Select the Feedback Gain display page by pressing the **PAGE+** or **PAGE-** button. The current level flashes under the “F.GAIN” prompt.

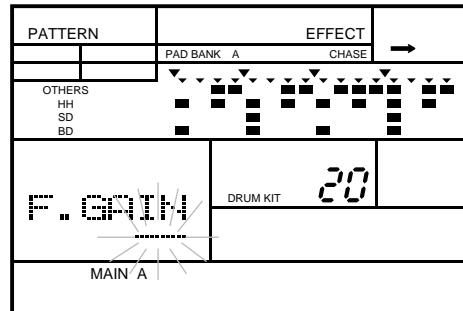

NOTE

Feedback gain can only be applied to the delay effects. When the reverberation effects are selected, “-” is displayed.

- 2** Set the feedback gain by rotating the Jog Dial or by using the **+1** and **-1** buttons. The range is from “00” to “31”.

NOTE

You can change the Feedback Gain for the preset drum kits. Your altered setting will stay in effect until you select another drum kit.

■ Delay Time

In this mode, you can adjust the right and left channel delays.



- 1 Select the Delay Time display page by pressing the **PAGE+** or **PAGE-** button. The current levels are displayed under the “D. TIME” prompt with the left channel level flashing.

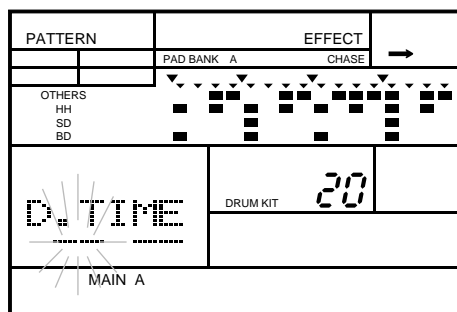







NOTE

As with feedback gain, the delay time setting can only be applied to the delay effects. When the reverberation effects are selected, “-- --” is displayed.

- 2 Set the left channel delay time by rotating the Jog Dial or by using the **+1** and **-1** buttons.

For the delays “DELY1” and “DELY2”, the range is “00” to “99”. These settings change the length of the delay loop for each channel. A low value sets a short loop while a high value sets a long loop.

The other two delays, “DELY3” and “DELY4”, use synchronized delays:

- T0  Sets a 32nd note triplet delay.
- T1  Sets a 32nd note delay.
- T2  Sets a 16th note triplet delay.
- T3  Sets a 16th note delay.
- T4  Sets an eighth note triplet delay.
- T5  Sets an eighth note delay.



- 3 Change the focus to the right channel delay time by pressing the **▶** cursor button. Set its value by rotating the Jog Dial or by using the **+1** and **-1** buttons.

HINT

For the most realistic effect, you should try to use slightly different values for each of the two channels.

NOTE

You can change the Delay Time for the preset drum kits. Your altered setting will stay in effect until you select another drum kit

IMPORTANT

The delays, “DELY3” and “DELY4”, may not be synchronized with the tempo if you slow the tempo down too far. This is because the RY20 can only work within a maximum delay time of approximately 380 milliseconds.

The synchronized delays may be incorrectly reproduced when they are controlled through an external MIDI device’s clock.

Changing the tempo during playback while using the synchronized delays may momentarily mute the sounds.

11

MIDI Functions

The RY20 is a fully functional MIDI instrument. It can send or receive MIDI data through its MIDI IN and OUT connectors. You can play its voices from another instrument or you can use it to control other MIDI devices, such as keyboards or tone generators. You can connect your RY20 to a MIDI data storage device, such as the Yamaha MDF2 MIDI Data Filer, to perform back-ups of your valuable pattern, song and drum pad data.

■ MIDI Sync

This mode determines whether the RY20 timing is synchronized by its own internal clock or by an external MIDI clock.

MIDI

- 1 Put the RY20 in MIDI Mode by pressing the **MIDI** button. Notice that the “MIDI” indicator is switched on. The current mode is flashing below the “SYNC” prompt.

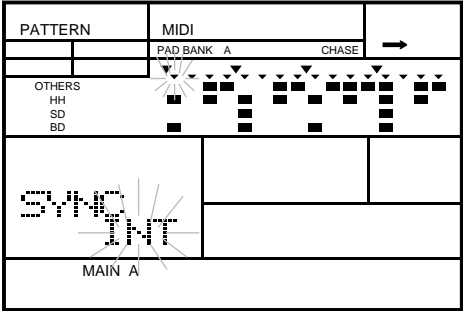

NOTE

From the initial display page in MIDI Mode, pressing the **MIDI** button will switch the RY20 back to the previously selected play mode, such as Pattern or Song Play Mode. From the other display pages of MIDI Mode, pressing the **MIDI** button will switch to the mode’s initial display page.

Please note that you CANNOT select MIDI Mode while the RY20 is playing or in Pattern or Song Record Mode. You also cannot start Pattern or Song playback while the RY20 is in MIDI Mode.

- Switch from “INT” (internal clock, the default) to “MIDI” (external MIDI controller) by rotating the Jog Dial or by using the **+1** and **-1** buttons.

If you are using the RY20 with an external sequencer, synthesizer, or other MIDI device, set this function to “MIDI”. The external device must be transmitting an appropriate MIDI clock signal. Note that the “MIDI SYNC” indicator is lit up.

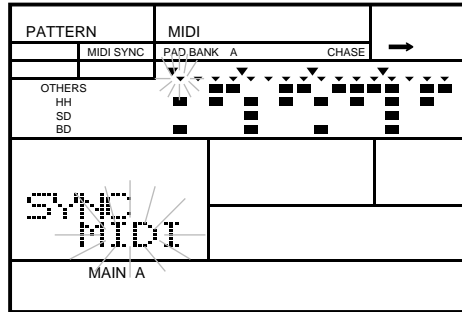
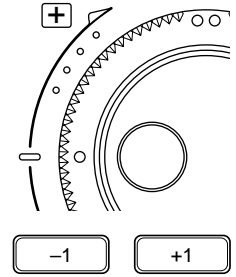

IMPORTANT

When there is no external MIDI device, this function **MUST** be set to “INT” (internal clock).

“INT” is the normal setting when the RY20 is being used by itself.

■ Drum Instruments MIDI Channel

Set the transmission and reception channel for the drum instruments. A separate channel is provided for the bass instrument.

- Select the Drum Instruments display page by pressing the **PAGE+** or **PAGE-** button. The current channel flashes beside the “CH” prompt.

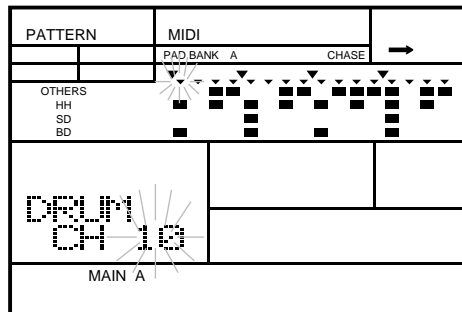

- 2 Select a channel by rotating the Jog Dial or by using the **+1** and **-1** buttons.

The channel choices are “01” to “16” and “OFF”. The default channel is “10”. Pressing the **+1** and **-1** buttons simultaneously resets the channel to “10”.

Use “OFF” if you do not want the RY20’s drum instruments to respond to MIDI commands.

■ Bass Instrument MIDI Channel

Set the transmission and reception channel for the bass instrument.



- 1 Select the Bass Instrument display page by pressing the **PAGE+** or **PAGE-** button. The current channel flashes beside the “CH” prompt.

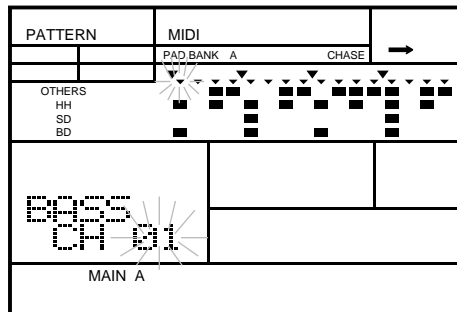

- 2 Select a channel by rotating the Jog Dial or by using the **+1** and **-1** buttons.

The channel choices are “01” to “16” and “OFF”. The default channel is “01”. Pressing the **+1** and **-1** buttons simultaneously resets the channel to “01”.

Select “OFF” if you do not want the bass instruments to respond to MIDI commands.

NOTE

If you select the same channel as the drum channel, the drum instruments are given priority over the bass instruments.

■ Program Change MIDI Channel

The RY20 receives program change messages from external MIDI devices. They are used to change the drum kit number. Program change messages are transmitted, for example, by a MIDI keyboard whenever one of its voice selectors is pressed.

- 1 Select the Program Change display page by pressing the **PAGE+** or **PAGE-** button. The current channel flashes beside the “CH” prompt.

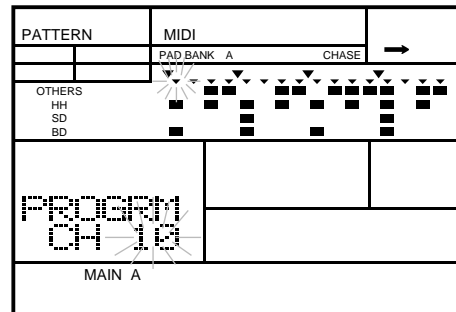

- 2 Select a receive channel by rotating the Jog Dial or by using the **+1** and **-1** buttons.

The channel choices are “01” to “16” and “OFF”. The default channel is “10”. Pressing the **+1** and **-1** buttons simultaneously resets the channel to “10”.

Select “OFF” if you do not want the RY20 to respond to program change messages.

Refer to the Drum Kit List on page 122 for the program change numbers exclusive to each drum kit.

■ MIDI Note Assignment

The RY20 has four types of note number tables. Each table contains a list of the drum pads and the corresponding MIDI note number.

MIDI Note Tables



- 1 Select the Note Table display page by pressing the **PAGE+** or **PAGE-** button. The current table flashes below the “NT TBL” prompt.

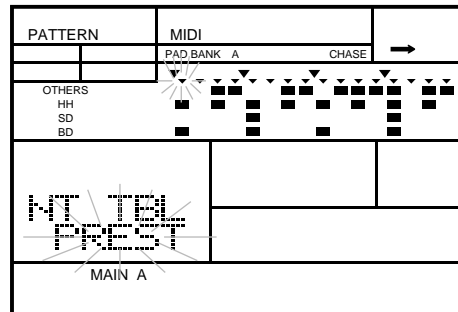

- 2 Select a table by rotating the Jog Dial or by using the **+1** and **-1** buttons.

The RY20 has four note tables: “PREST”, “USER1”, “USER2”, and “USER3”. The default is “PREST”, the preset table. The preset table is set to GM (General MIDI) Level1, to enable communication with external GM devices.

NOTE

You must select one of the user tables, “USER1” to “USER3”, in order to change the note assignments in the next display page.

Factory Set Values:

PREST	GM (General MIDI Level 1)
USER1	GM (same as PREST but available for editing)
USER2	Yamaha RX series
USER3	Keyboard linear (Note 36 = Pad 0 to Note 95 = Pad 59)

MIDI Note Numbers

- 1** Select the Note Number display page by pressing the **PAGE+** or **PAGE-** button. The current note number flashes next to the “NT” prompt.

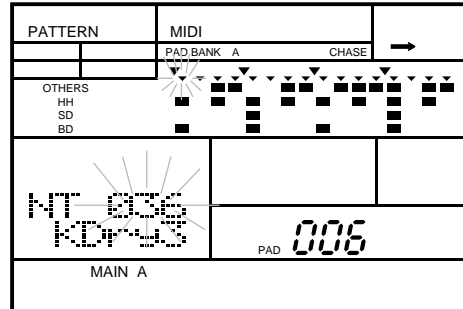

- 2** Press the drum pad you want to modify.
- 3** Change the MIDI note number of the current pad by rotating the Jog Dial or by using the **+1** and **-1** buttons.

For the drum pads from “000” to “059” (the drum voices) you can assign an individual MIDI note number in the range of “000” to “127” or “OFF”.

For the drum pads from “060” to “119” (the bass voices) you can assign a MIDI note number in the range of “000” to “127”. However, all the note numbers will be affected by the change. (The note number range depends on which pad you select.)

NOTE

You can use Pad Bank Mode to select another group of drum pads. See page 84 for instructions regarding Pad Bank Mode.

An alternative method is to press the **▶** cursor button to change the focus to the pad prompt (the “PAD” indicator starts flashing). Select a pad with the Jog Dial or by using the **+1** and **-1** buttons, then press the **◀** cursor button to change the focus back to the note assignment.



NOTE

If you are modifying the drum voices and did not select one of the user tables with the previous display page, you will see the error message “PRESET” when you attempt to modify the table. The preset table contains the mapping for General MIDI drum voices and cannot be changed. However, if you are modifying the bass voice, you can change the value of the preset table.

■ Volume and Expression

MIDI Volume

The volume setting is used to control the volume level of the individual MIDI channels: Drum and Bass.



- 1 Select the Volume display page by pressing the **PAGE+** or **PAGE-** button. The current instrument flashes below the “VOLUME” prompt.

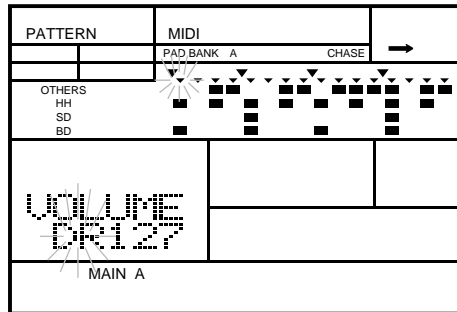

- 2 Select the instrument “DR” (drums) or “BS” (bass) by rotating the Jog Dial or by using the **+1** and **-1** buttons.
- 3 Change the focus area to the volume data by pressing the **▶** cursor button.
- 4 Change the volume by rotating the Jog Dial or by using the **+1** and **-1** buttons.

The default is “127”. The range is “000” to “127”.

NOTE

The volume setting affects the sounds produced by tapping the drum pads, or note events from the internal sequencer or an external MIDI device.

MIDI Expression

The expression setting adds accentuation to the volume level of the individual MIDI channels: Drum and Bass.

- 1 Select the Expression display page by pressing the **PAGE+** or **PAGE-** button. The current instrument flashes below the “EXPRES” prompt.

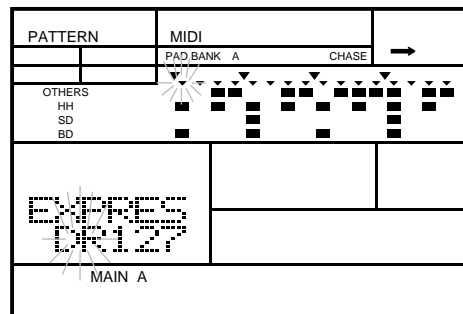

- 2 Select the instrument “DR” (drums) or “BS” (bass) by rotating the Jog Dial or by using the **+1** and **-1** buttons.

NOTE

If you changed the instrument on the previous display page, it will already be changed on this page. In the same way, changing the instrument on this page changes it on the previous display page.

- 3 Change the focus area to the expression data by pressing the **▶** cursor button.
- 4 Change the expression by rotating the Jog Dial or by using the **+1** and **-1** buttons.

The default is “127”. The range is “000” to “127”.

NOTE

The expression setting affects the sounds produced by tapping the drum pads, or note events from the internal sequencer or an external MIDI device.

The expression setting is always reset to the default when you turn on your RY20.

■ Bulk Dump

The final MIDI function allows you to make back-ups of your RY20 by dumping your pattern and song sequences and drum kit data to a MIDI data file such as the Yamaha MDF2.



- 1 Select the Bulk Dump display page by pressing the **PAGE+** or **PAGE-** button.

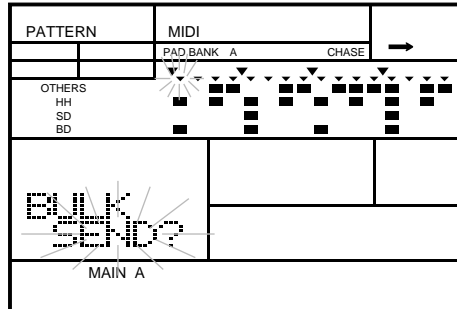

- 2 Press the **ENTER** button to execute the request. The prompt “BULK SEND” appears momentarily on the LCD followed by the prompt “END” when the transmission has finished.

■ Receiving Bulk Data

The RY20 can also read back data which you had previously saved to an external MIDI storage device.

- 1 Turn the RY20 on by pressing the Power switch ON. Select Song Play Mode or Pattern Play Mode. (By default, the RY20 powers up in Pattern Play Mode.)

IMPORTANT

Do NOT select one of the sub-functions. The RY20 cannot receive MIDI Bulk Data when it is set to one of its sub-functions.

- 2 Send the bulk data from the external device.

For instructions about sending bulk data, please refer to the owner’s manual for the external MIDI device.

The message “RECEIV BULK” appears on the display during execution of the data transmission.

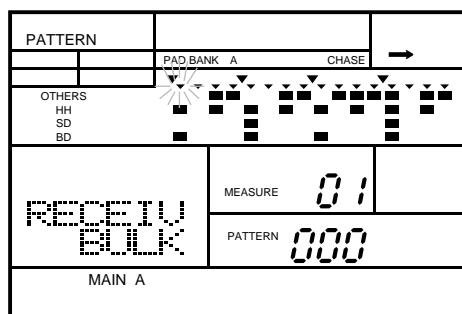

WARNING

When the RY20 receives bulk data, it is stored in the same locations it was in when it was dumped to the external MIDI data storage device. This means that any pattern or song data which you recorded after performing the bulk dump will be overwritten by the bulk receive.

BE SURE THIS IS WHAT YOU INTEND TO DO.



Appendix

■ Total Reset Procedure

The following procedure can be used to reset ALL the RY20 parameters to their initial default settings. It will clear ALL the patterns, songs, and kits you have created.

IMPORTANT

Be sure to save any data you want to keep on a MIDI data storage device such as the Yamaha MDF2 MIDI Data Filer before you carry out the total reset procedure.

1 Turn the RY20 power OFF.



2 Press and hold both the **+1** and **-1** buttons. Turn the power back on. “FACTRY SET” will momentarily appear on the display and the Record and Play LEDs will flash.

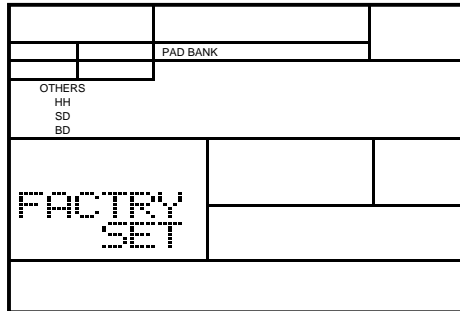

The “YAMAHA RY20” prompt will appear, then the instrument will default to Pattern Play Mode.

Pattern List

No	Type	LCD Name	Name	Time Signature	No	Type	LCD Name	Name	Time Signature
0	Pop	8bPop	8-beat Pop	4/4	25	Dance	House	House	4/4
1		16bPp	16-beat Pop	4/4	26		DncPp	Dance Pop	4/4
2		D.Pop	Detroit Pop	4/4	27		B.C	Black Contemporary	4/4
3		24Sf1	24-beat Shuffle 1	4/4	28		Tecno	Techno	4/4
4		24Sf2	24-beat Shuffle 2	4/4	29		Acid	Acid	4/4
5	Rock	Rock1	Rock 1	4/4	30	Rap	Rap	4/4	
6		Rock2	Rock 2	4/4	31	DncSf	Dance Shuffle	4/4	
7		Rock3	Rock 3	4/4	32	R&R	BgWgy	Boogie Woogie	4/4
8		HRock	Hard Rock	4/4	33	Swing	Rag	Ragtime	4/4
9		Metal	Metal	4/4	34		Swing	Swing	4/4
10		RckSf	Rock Shuffle	4/4	35		BeBop	BeBop	4/4
11		RkBgy	Rock Boogie	4/4	36		JWalz	Jazz Waltz	3/4
12		5/4Rk	5/4 Rock	5/4	37	Fusion	Fusn1	Fusion 1	4/4
13		7/8Rk	7/8 Rock	7/8	38		Fusn2	Fusion 2	4/4
14		Bald1	Piano Ballad	4/4	39		Fusn3	Fusion Shuffle	4/4
15	Ballad	Bald2	R&B Ballad	4/4	40	Latin	Mambo	Mambo	4/4
16		Bald3	Ballad	4/4	41		Samb1	Samba	4/4
17		Bald4	6/8 Ballad	4/4	42		Samb2	Jazz Samba	4/4
18		Bald5	Analog Ballad	4/4	43		Bossa	Bossa Nova	4/4
19		Rhythm & Blues	Blues	6/8 Blues	4/4		44	ChCha	Cha Cha
20	Gspl1		6/8 Gospel	6/8	45		Bomba	Bomba	4/4
21	Gspl2		Fast Gospel	4/4	46	Caribbean	Rege1	Reggae 1	4/4
22	Funk		Funk	4/4	47		Rege2	Reggae 2	4/4
23	Dance		Disco	Disco Funk	4/4		48	Ska	Ska
24		Euro	EuroBeat	4/4	49		Clyps	Calypso	4/4

Drum Kit List

Preset	Kit Number	0	1	2	3	4	5	6	7	8	9	
	Program No.	0	1	2	3	4	5	8	16	17	24	
User (defaults)	Kit Number	20	21	22	23	24	25	26	27	28	29	
	Program No.	64	65	66	67	68	69	72	80	81	88	
LCD Name		Stand	Balad	Pops	R&B	Funk	Regae	Room	Rock	Power	Elctr	
Kit Name		Standard	Ballad	Pops	Rhythm & Blues	Funk	Reggae	Room	Rock	Power	Electronic	
Effect		HALL1	HALL2	ROOM1	ROOM2	ROOM2	HALL1	ROOM1	PLAT1	PLAT2	HALL1	
Pad No.	Note No.	Note										
0	48	C2	TDryH	TRomH	TDryH	TDryH	TDryH	Ethn1	TRomH	TPwrH	TPwrH	TElc1
1	47	B1	TDryM	TRomM	TDryM	TDryM	TDryM	Ethn1	TRomM	TPwrM	TPwrM	TElc1
2	45	A1	TDryL	TRomL	TDryL	TDryL	TDryL	Ethn1	TRomL	TPwrL	TPwrL	TElc1
3	43	G1	TDryF	TRomF	TDryF	TDryF	TDryF	Ethn1	TRomF	TPwrF	TPwrF	TElc1
4	46	A#1	HOMid	HOMid	HOMid	HOMid	HOMid	HOMid	HOMid	HOMid	HOMid	HOMid
5	59	B2	RdHi	RdHi	RdHi	RdHi	RdHi	RdHi	RdHi	RdHi	RdHi	RdHi
6	36	C1	KDry3	KGat3	KTgt3	KDry3	KTgt5	KTgt6	KGat8	KGat2	KRck2	KELc3
7	38	D1	SDry5	SDry6	SPic1	SDry1	SPr8	STgt8	SPr5	SRck8	SPwr1	SELc1
8	37	C#1	Rim1	Rim1	Rim1	Rim1	Rim1	Rim1	Rim1	Rim1	Rim1	Rim1
9	44	G#1	HPed1	HPed1	HPed1	HPed1	HPed1	HPed1	HPed1	HPed1	HPed1	HPed1
10	42	F#1	HCls1	HCls4	HCls1	HCls1	HCls1	HCls1	HCRom	HCSt2	HCSt2	HCls1
11	49	C#2	Crsh1	Crsh1	Crsh1	Crsh1	Crsh1	Crsh1	Crsh1	Crsh3	Crsh3	Crsh1
12	35	B0	KTgt3	KDry3	KDry2	KJaz6	KDry3	KTgt3	KGat4	KGat9	KGat7	KELc1
13	40	E1	SPic2	SRck5	SPr6	SPic3	SPic3	SRim2	SPr9	SRck5	SRck5	TElc2
14	50	D2	TDryH	TRomH	TDryH	TDryH	TDryH	Ethn1	TRomH	TPwrH	TPwrH	TElc1
15	41	F1	TDryF	TRomF	TDryF	TDryF	TDryF	Ethn1	TRomF	TPwrF	TPwrF	TElc1
16	25	C#0	BrTap	BrTap	BrTap	BrTap	BrTap	BrTap	BrTap	BrTap	BrTap	BrTap
17	27	D#0	BrSlp	BrSlp	BrSlp	BrSlp	BrSlp	BrSlp	BrSlp	BrSlp	BrSlp	BrSlp
18	33	A0	KDry2	KDry1	KGat2	KDry1	KGat2	KDry1	KAmb1	KRck1	KGat2	KGat2
19	31	G0	SDry4	SRck2	SDry4	SDry4	SPr11	SPr1	SAMB2	SRck2	SPwr2	SELc2
20	34	A#0	SRim1	SRim3	SRim2	SRim5	SRim2	SRim5	SRim2	SRim2	SPr9	STgt8
21	29	F0	SRoll	SRoll	SRoll	SRoll	SRoll	SRoll	SRoll	SRoll	SRoll	SRoll
22	26	D0	BrSwL	BrSwL	BrSwL	BrSwL	BrSwL	BrSwL	BrSwL	BrSwL	BrSwL	BrSwL
23	28	E0	BrSwH	BrSwH	BrSwH	BrSwH	RevrS	BrSwH	BrSwH	BrSwH	BrSwH	RevrS
24	67	G3	AgogH	AgogH	AgogH	AgogH	AgogH	AgogH	AgogH	AgogH	AgogH	AgogH
25	68	C#3	AgogL	AgogL	AgogL	AgogL	AgogL	AgogL	AgogL	AgogL	AgogL	AgogL
26	83	B4	JBell	JBell	JBell	JBell	JBell	JBell	JBell	JBell	JBell	JBell
27	84	C5	BelTr	BelTr	BelTr	BelTr	BelTr	BelTr	BelTr	BelTr	BelTr	BelTr
28	51	D#2	RdMd	RdMd	RdMd	RdMd	RdMd	RdMd	RdLo	RdMd	RdMd	RdMd
29	53	F2	Cup1	Cup1	Cup1	Cup1	Cup1	Cup1	Cup1	Cup2	Cup2	Cup1
30	80	G#4	TriM	TriM	TriM	TriM	TriM	TriM	TriM	TriM	TriM	TriM
31	81	A4	TriO	TriO	TriO	TriO	TriO	TriO	TriO	TriO	TriO	TriO
32	56	G#2	Cowbl	Cowbl	Cowbl	Cowbl	Cowbl	Cowbl	Cowbl	Cowbl	Cowbl	Cowbl
33	55	G2	Spls1	Spls1	Spls1	Spls1	Spls1	Spls1	Spls1	Spls1	Spls1	Spls2
34	52	E2	Chns1	Chns1	Chns1	Chns1	Chns1	Chns1	Chns1	Chns1	Chns1	Chns1
35	57	A2	Crsh2	Crsh2	Crsh2	Crsh2	Crsh2	Crsh2	Crsh2	Crsh5	Crsh5	Crsh2
36	65	F3	TmblH	TmblH	TmblH	TmblH	TmblH	TmblH	TmblH	TmblH	TmblH	TmblH
37	66	F#3	TmblL	TmblL	TmblL	TmblL	TmblL	TmblL	TmblL	TmblL	TmblL	TmblL
38	78	F#4	CuicM	CuicM	CuicM	CuicM	CuicM	CuicM	CuicM	CuicM	CuicM	ScrH
39	79	G4	CuicO	CuicO	CuicO	CuicO	CuicO	CuicO	CuicO	CuicO	CuicO	ScrL
40	71	B3	WhstH	WhstH	WhstH	WhstH	WhstH	WhstH	WhstH	WhstH	WhstH	WhstH
41	72	C4	WhstL	WhstL	WhstL	WhstL	WhstL	WhstL	WhstL	WhstL	WhstL	WhstL
42	60	C3	BongH	BongH	BongH	BongH	BongH	BongH	BongH	BongH	BongH	BongH
43	61	C#3	BongL	BongL	BongL	BongL	BongL	BongL	BongL	BongL	BongL	BongL
44	62	D3	CongM	CongM	CongM	CongM	CongM	CongM	CongM	CongM	CongM	CongM
45	63	D#3	CongH	CongH	CongH	CongH	CongH	CongH	CongH	CongH	CongH	CongH
46	64	E3	CongL	CongL	CongL	CongL	CongL	CongL	CongL	CongL	CongL	CongL
47	54	F#2	Tmbrn	Tmbrn	Tmbrn	Tmbrn	Tmbrn	Tmbrn	Tmbrn	Tmbrn	Tmbrn	Tmbrn
48	76	E4	WdB1H	WdB1H	WdB1H	WdB1H	WdB1H	WdB1H	WdB1H	WdB1H	WdB1H	WdB1H
49	77	F4	WdB1L	WdB1L	WdB1L	WdB1L	WdB1L	WdB1L	WdB1L	WdB1L	WdB1L	WdB1L
50	75	D#4	Clave	Clave	Clave	Clave	Clave	Clave	Clave	Clave	Clave	Clave
51	30	F#0	Casta	Casta	Casta	Casta	Casta	Casta	Casta	Casta	Casta	HighQ
52	58	A#2	Vibra	Vibra	Vibra	Vibra	Vibra	Vibra	Vibra	Vibra	Vibra	Vibra
53	32	C#0	Stick	Stick	Stick	Stick	Stick	Stick	Stick	Stick	Stick	Stick
54	73	C#4	GuirS	GuirS	GuirS	GuirS	GuirS	GuirS	GuirS	GuirS	GuirS	GuirS
55	74	D4	GuirL	GuirL	GuirL	GuirL	GuirL	GuirL	GuirL	GuirL	GuirL	GuirL
56	69	A3	Cabas	Cabas	Cabas	Cabas	Cabas	Cabas	Cabas	Cabas	Cabas	Cabas
57	70	A#3	Marac	Marac	Marac	Marac	Marac	Marac	Marac	Marac	Marac	Marac
58	82	A#4	Shakr	Shakr	Shakr	Shakr	Shakr	Shakr	Shakr	Shakr	Shakr	Shakr
59	39	D#1	Clap	Clap	Clap	Clap	Clap	Clap	Clap	Clap	Clap	Clap
60~119			BFngr	BFngr	BFngr	BPick	BSlpl	BFngr	BFngr	BPick	BPick	BFngr

Preset	Kit Number	10	11	12	13	14	15	16	17	18	19	
	Program No.	25	26	27	28	29	30	32	33	40	48	
User (defaults)	Kit Number	30	31	32	33	34	35	36	37	38	39	
	Program No.	89	90	91	92	93	94	96	97	104	112	
LCD Name		Analg	Dance	Rap	Tech	SE1	SE2	Jazz	Fusin	Brush	Class	
Kit Name		Analog	Dance	Rap	Techno	Sound Effect1	Sound Effect2	Jazz	Fusion	Brush	Classic	
Effect		HALL1	PLAT1	PLAT1	PLAT1	HALL1	PLAT2	ROOM2	PLAT2	HALL1	HALL2	
Pad No.	Note No.	Note										
0	48	C2	TAn1	TElcl	TElcl	TElcl	TAn1	Ethnl	TJazH	TDryH	TBrSH	TJazH
1	47	B1	TAn1	TElcl	TElcl	TElcl	TAn1	Ethnl	TJazM	TDryM	TBrSM	TJazM
2	45	A1	TAn2	TElcl	TElcl	TElcl	TAn2	Ethnl	TJazL	TDryL	TBrSL	TJazL
3	43	G1	TAn2	TElcl	TElcl	TElcl	TAn2	Ethnl	TJazF	TDryF	TBrSF	TJazF
4	46	A#1	HOAn	HOHi	HOHi	HOHi	HOAn	HOAn	HOMid	HOHi	HOMid	HOMid
5	59	B2	RdLo	RdHi	RdHi	RdLo	RdLo	Bot12	RdHi	RdHi	RdBr	OCymC
6	36	C1	KAn5	KAn3	KVoc2	KTec1	KVoc1	KTec7	KJaz3	KTgt1	KJaz4	GrnC5
7	38	D1	SAn1	SPr10	STgt3	SAn6	SSfx5	TSE1	SDry4	SPic2	BrSlp	SDry4
8	37	C#1	RimA1	Rim1	Rim1	RimA1	RimA1	Bot11	Rim2	Rim1	Rim2	Rim2
9	44	G#1	HCAAn2	HPed1	HPed1	HPed1	HCAAn2	HPed1	HPed1	HPed1	HPed1	HPed1
10	42	F#1	HCAAn1	HCls1	HCls1	HCls1	HCAAn1	HCAAn1	HCSt1	HCSt2	HCls1	HCSt1
11	49	C#2	AnCrs	Crsh1	Crsh1	Crsh1	AnCrs	Mnstr	Crsh1	Crsh5	Crsh1	OCymO
12	35	B0	KAn7	KElc2	KVoc1	KTec5	KSfx1	KSfx1	KJaz6	KDry2	KJaz2	GrnC5
13	40	E1	SAn3	STgt1	SSfx7	SSfx2	SSfx6	Taiko	STgt5	STgt5	BrTap	STgt8
14	50	D2	TAn1	TElcl	TElcl	TElcl	TAn1	Ethnl	TJazH	TDryH	TBrSH	TJazH
15	41	F1	TAn2	TElcl	TElcl	TElcl	TAn2	Ethnl	TJazF	TDryF	TBrSF	TJazF
16	25	C#0	BrTap	BrTap	BrTap	BrTap	BrTap	BrTap	BrTap	BrTap	BrTap	BrTap
17	27	D#0	BrSlp	BrSlp	BrSlp	BrSlp	BrSlp	BrSlp	BrSlp	BrSlp	BrSlp	BrSlp
18	33	A0	KVoc5	KGat5	KGat2	KTec6	KTec7	BgPip	KJaz4	KDry1	KDry1	KJaz4
19	31	G0	SAn10	SAn10	SAn10	SAn9	SSfx3	Bot11	STgt7	SDry5	BrSlp	STgt7
20	34	A#0	STgt4	SRim4	STgt8	STgt4	TSE2	SVoc3	SRim3	SRim1	BrSwH	SRim3
21	29	F0	SRoll	SRoll	SRoll	SRoll	SRoll	SRoll	SRoll	SRoll	SRoll	SRoll
22	26	D0	BrSwL	BrSwL	BrSwL	BrSwL	BrSwL	BrSwL	BrSwL	BrSwL	BrSwL	BrSwL
23	28	E0	Revrs	Revrs	Revrs	Revrs	Revrs	Revrs	BrSwH	BrSwH	BrSwH	BrSwH
24	67	G3	AgogH	AgogH	AgogH	AgogH	AgogH	AgogH	AgogH	AgogH	AgogH	AgogH
25	68	G#3	AgogL	AgogL	AgogL	AgogL	AgogL	AgogL	AgogL	AgogL	AgogL	AgogL
26	83	B4	JBell	JBell	JBell	JBell	JBell	JBell	JBell	JBell	JBell	JBell
27	84	C5	BelTr	BelTr	BelTr	BelTr	BelTr	BelTr	BelTr	BelTr	BelTr	BelTr
28	51	D#2	RdMd	RdMd	RdMd	RdMd	CymE3	SFX4	RdMd	RdLo	RdLo	OCymC
29	53	F2	Cup1	Cup1	Cup1	Cup1	Gong2	Bomb2	Cup1	Cup1	Cup1	CrRol
30	80	G#4	TriM	TriM	TriM	TriM	Bot12	SFX2	TriM	TriM	TriM	TriM
31	81	A4	TriO	TriO	TriO	TriO	Ethnl	SFX3	TriO	TriO	TriO	TriO
32	56	G#2	AnCow	AnCow	Cowbl	AnCow	AnCow	AnCow	Cowbl	Cowbl	Cowbl	Cowbl
33	55	G2	Spls2	Spls2	Spls2	Spls3	Spls2	Spls2	Spls1	Spls1	Spls1	Spls1
34	52	E2	Chns2	Chns1	Chns1	Chns1	Chns2	SFX5	Chns1	Chns1	Chns1	Chns1
35	57	A2	Crsh1	Crsh2	CymE2	Crsh1	CrRol	Wbell	Crsh2	Crsh2	Crsh2	OCymO
36	65	F3	TmbLH	TmbLH	TmbLH	TmbLH	TmbLH	TmbLH	TmbLH	TmbLH	TmbLH	TmbLH
37	66	F#3	TmbLL	TmbLL	TmbLL	TmbLL	TmbLL	TmbLL	TmbLL	TmbLL	TmbLL	TmbLL
38	78	F#4	ScrH	ScrH	ScrH	ScrH	ScrH	ScrH	CuicM	CuicM	CuicM	CuicM
39	79	G4	ScrL	ScrL	ScrL	ScrL	ScrL	ScrL	CuicO	CuicO	CuicO	CuicO
40	71	B3	WhstH	WhstH	WhstH	WhstH	WhstH	WhstH	WhstH	WhstH	WhstH	WhstH
41	72	C4	WhstL	WhstL	WhstL	WhstL	WhstL	WhstL	WhstL	WhstL	WhstL	WhstL
42	60	C3	BongH	BongH	BongH	BongH	BongH	BongH	BongH	BongH	BongH	BongH
43	61	C#3	BongL	BongL	BongL	BongL	BongL	BongL	BongL	BongL	BongL	BongL
44	62	D3	AnCgH	CongM	CongM	AnCgH	AnCgH	AnCgH	CongM	CongM	CongM	CongM
45	63	D#3	AnCgM	CongH	CongH	AnCgM	AnCgM	AnCgM	CongH	CongH	CongH	CongH
46	64	E3	AnCgL	CongL	CongL	AnCgL	AnCgL	AnCgL	CongL	CongL	CongL	CongL
47	54	F#2	Tmbrn	Tmbrn	Tmbrn	Tmbrn	Tmbrn	Tmbrn	Tmbrn	Tmbrn	Tmbrn	Tmbrn
48	76	E4	WdB1H	WdB1H	WdB1H	WdB1H	WdB1H	WdB1H	WdB1H	WdB1H	WdB1H	WdB1H
49	77	F4	WdB1L	WdB1L	WdB1L	WdB1L	WdB1L	WdB1L	WdB1L	WdB1L	WdB1L	WdB1L
50	75	D#4	AnClv	Clave	Clave	AnClv	AnClv	AnClv	Clave	Clave	Clave	Clave
51	30	F#0	HighQ	HighQ	HighQ	HighQ	HighQ	HighQ	Casta	Casta	Casta	Casta
52	58	A#2	Vibra	Vibra	Vibra	Vibra	Vibra	Vibra	Vibra	Vibra	Vibra	Vibra
53	32	G#0	Stick	Stick	Stick	Stick	Stick	Stick	Stick	Stick	Stick	Stick
54	73	C#4	GuirS	GuirS	GuirS	GuirS	GuirS	GuirS	GuirS	GuirS	GuirS	GuirS
55	74	D4	GuirL	GuirL	GuirL	GuirL	GuirL	GuirL	GuirL	GuirL	GuirL	GuirL
56	69	A3	Cabas	Cabas	Cabas	Cabas	Cabas	Cabas	Cabas	Cabas	Cabas	Cabas
57	70	A#3	AnMrc	Marac	Marac	AnMrc	AnMrc	AnMrc	Marac	Marac	Marac	Marac
58	82	A#4	Shakr	Shakr	Shakr	Shakr	Shakr	Shakr	Shakr	Shakr	Shakr	Shakr
59	39	D#1	Clap	Clap	Clap	Clap	Clap	Clap	Clap	Clap	Clap	Clap
60~119			BSyn2	BSyn1	BSyn2	BSyn2	BSyn2	BSyn2	BACO	BFngr	BACO	BACO

Voice List

No	LCD Name	Name	Elements	Note Off	No	LCD Name	Name	Elements	Note Off
0	KTgt1	Tight kick 1	1		74	SLgt6	Light snare 6	1	
1	KTgt2	Tight kick 2	2		75	SLgt7	Light snare 7	1	
2	KTgt3	Tight kick 3	2		76	SLgt8	Light snare 8	1	
3	KTgt4	Tight kick 4	2		77	SLgt9	Light snare 9	2	
4	KTgt5	Tight kick 5	2		78	STgt1	Tight snare 1	2	
5	KTgt6	Tight kick 6	2		79	STgt2	Tight snare 2	2	
6	KDry1	Dry kick 1	1		80	STgt3	Tight snare 3	2	
7	KDry2	Dry kick 2	2		81	STgt4	Tight snare 4	2	
8	KDry3	Dry kick 3	2		82	STgt5	Tight snare 5	2	
9	KDry4	Dry kick 4	2		83	STgt6	Tight snare 6	2	
10	KJaz1	Jazz kick 1	1		84	STgt7	Tight snare 7	1	
11	KJaz2	Jazz kick 2	2		85	STgt8	Tight snare 8	1	
12	KJaz3	Jazz kick 3	2		86	SRim1	Rim snare 1	1	
13	KJaz4	Jazz kick 4	2		87	SRim2	Rim snare 2	1	
14	KJaz5	Jazz kick 5	2		88	SRim3	Rim snare 3	2	
15	KJaz6	Jazz kick 6	2		89	SRim4	Rim snare 4	1	
16	KRck1	Rock kick 1	2		90	SRim5	Rim snare 5	1	
17	KRck2	Rock kick 2	2		91	SRck1	Rock snare 1	2	
18	KGat1	Gate kick 1	2		92	SRck2	Rock snare 2	2	
19	KGat2	Gate kick 2	2		93	SRck3	Rock snare 3	2	
20	KGat3	Gate kick 3	2		94	SRck4	Rock snare 4	1	
21	KGat4	Gate kick 4	2		95	SRck5	Rock snare 5	2	
22	KGat5	Gate kick 5	2		96	SRck6	Rock snare 6	2	
23	KGat6	Gate kick 6	2		97	SRck7	Rock snare 7	2	
24	KGat7	Gate kick 7	2		98	SRck8	Rock snare 8	2	
25	KGat8	Gate kick 8	2		99	SPwr1	Power snare 1	2	
26	KGat9	Gate kick 9	2		100	SPwr2	Power snare 2	2	
27	KAmb1	Ambient kick 1	2		101	SPwr3	Power snare 3	2	
28	KAmb2	Ambient kick 2	2		102	SPr1	Processed snare 1	2	
29	KAmb3	Ambient kick 3	2		103	SPr2	Processed snare 2	2	
30	KAn1	Analog kick 1	2		104	SPr3	Processed snare 3	2	
31	KAn2	Analog kick 2	2		105	SPr4	Processed snare 4	2	
32	KAn3	Analog kick 3	2		106	SPr5	Processed snare 5	2	
33	KAn4	Analog kick 4	2		107	SPr6	Processed snare 6	2	
34	KAn5	Analog kick 5	2		108	SPr7	Processed snare 7	2	
35	KAn6	Analog kick 6	2		109	SPr8	Processed snare 8	2	
36	KAn7	Analog kick 7	2		110	SPr9	Processed snare 9	2	
37	KAn8	Analog kick 8	2		111	SPr10	Processed snare 10	2	
38	KTec1	Techno kick 1	2		112	SPr11	Processed snare 11	2	
39	KTec2	Techno kick 2	2		113	SAmb1	Ambient snare 1	2	
40	KTec3	Techno kick 3	1		114	SAmb2	Ambient snare 2	1	
41	KTec4	Techno kick 4	2		115	SAmb3	Ambient snare 3	2	
42	KTec5	Techno kick 5	2		116	SAAn1	Analog snare 1	1	
43	KTec6	Techno kick 6	2		117	SAAn2	Analog snare 2	1	
44	KTec7	Techno kick 7	2		118	SAAn3	Analog snare 3	2	
45	KElc1	Electronic kick 1	2		119	SAAn4	Analog snare 4	2	
46	KElc2	Electronic kick 2	2		120	SAAn5	Analog snare 5	2	
47	KElc3	Electronic kick 3	2		121	SAAn6	Analog snare 6	2	
48	KElc4	Electronic kick 4	2		122	SAAn7	Analog snare 7	2	
49	KElc5	Electronic kick 5	2		123	SAAn8	Analog snare 8	2	
50	KSfx1	SFX kick 1	2		124	SAAn9	Analog snare 9	2	
51	KSfx2	SFX kick 2	2		125	SAAn10	Analog snare 10	2	
52	KVoc1	Voice kick 1	2		126	SELc1	Electronic snare 1	2	
53	KVoc2	Voice kick 2	2		127	SELc2	Electronic snare 2	2	
54	KVoc3	Voice kick 3	2		128	SSfx1	SFX snare 1	1	
55	KVoc4	Voice kick 4	1		129	SSfx2	SFX snare 2	2	
56	KVoc5	Voice kick 5	2		130	SSfx3	SFX snare 3	2	
57	GrnCs	Gran cassa	2		131	SSfx4	SFX snare 4	2	
58	SDry1	Dry snare 1	1		132	SSfx5	SFX snare 5	2	
59	SDry2	Dry snare 2	1		133	SSfx6	SFX snare 6	2	
60	SDry3	Dry snare 3	2		134	SSfx7	SFX snare 7	2	
61	SDry4	Dry snare 4	1		135	SVoc1	Voice snare 1	1	
62	SDry5	Dry snare 5	1		136	SVoc2	Voice snare 2	1	
63	SDry6	Dry snare 6	2		137	SVoc3	Voice snare 3	2	
64	SDry7	Dry snare 7	2		138	SVoc4	Voice snare 4	2	
65	SDry8	Dry snare 8	2		139	SVoc5	Voice snare 5	1	
66	SPic1	Piccolo snare 1	1		140	SVoc6	Voice snare 6	1	
67	SPic2	Piccolo snare 2	1		141	SRo11	Snare roll	1	Fixed
68	SPic3	Piccolo snare 3	2		142	BrTap	Brush tap	1	
69	SLgt1	Light snare 1	2		143	BrSlp	Brush slap	1	
70	SLgt2	Light snare 2	2		144	BrSwL	Brush swirl low	1	Fixed
71	SLgt3	Light snare 3	2		145	BrSwH	Brush swirl high	2	Fixed
72	SLgt4	Light snare 4	2		146	Rim1	Rim shot 1	2	
73	SLgt5	Light snare 5	1		147	Rim2	Rim shot 2	2	

No	LCD Name	Name	Elements	Note Off	No	LCD Name	Name	Elements	Note Off
148	RimA1	Analog rim 1	2		224	TE1c1	Electronic tom 1	2	
149	RimA2	Analog rim 2	2		225	TE1c2	Electronic tom 2	2	
150	HClS1	Closed hi-hat 1	1		226	TSE1	SE tom 1	2	
151	HClS2	Closed hi-hat 2	2		227	TSE2	SE tom 2	1	
152	HClS3	Closed hi-hat 3	1		228	Casta	Castanet	1	
153	HClS4	Closed hi-hat 4	2		229	Clap	Hand clap	1	
154	HCRom	Room closed hi-hat	2		230	Tmbrn	Tambourine	2	
155	HCAmb	Ambient closed hi-hat	2		231	Cowbl	Cowbell	1	
156	HCSt1	SET closed hi-hat 1	1		232	Vibra	Vibraslap	1	
157	HCSt2	SET closed hi-hat 2	2		233	BongH	Bongo high	1	
158	HCSt3	SET closed hi-hat 3	2		234	BongL	Bongo low	1	
159	HOS4	SET open hi-hat 4	1		235	CongM	Conga high mute	1	
160	HOS5	SET open hi-hat 5	1		236	CongH	Conga high	1	
161	HOMid	Open hi-hat mid	1		237	CongL	Conga low	2	
162	HOHi	Open hi-hat high	1		238	Tmb1H	Timbale high	2	
163	HOMt1	Open hi-hat mute 1	1		239	Tmb1L	Timbale low	2	
164	HOMt2	Open hi-hat mute 2	1		240	AgogH	Agogo high	2	
165	HPed1	Pedal hi-hat	1		241	AgogL	Agogo low	2	
166	HCAAn1	Analog closed hi-hat 1	1		242	Cabas	Cabasa	1	
167	HCAAn2	Analog closed hi-hat 2	1		243	Marac	Maracas	1	
168	HOAn	Analog open hi-hat	1		244	WhstH	Samba whistle high	2	Fixed
169	RdHi	Ride cymbal high	2		245	WhstL	Samba whistle low	2	Fixed
170	RdMd	Ride cymbal mid	2		246	GuirS	Guiro short	1	
171	RdLo	Ride cymbal low	2		247	GuirL	Guiro long	1	Fixed
172	RdBr	Brush ride cymbal	2		248	Clave	Claves	2	
173	Cup1	Ride cymbal cup 1	2		249	WdB1H	Wood block high	2	
174	Cup2	Ride cymbal cup 2	2		250	WdB1L	Wood block low	2	
175	Cup3	Ride cymbal cup 3	2		251	CuicM	Cuica mute	1	
176	Cup4	Ride cymbal cup 4	2		252	CuicO	Cuica open	1	
177	Crsh1	Crash cymbal 1	1		253	TriM	Triangle mute	1	
178	Crsh2	Crash cymbal 2	1		254	TriO	Triangle open	1	
179	Crsh3	Crash cymbal 3	1		255	Shakr	Shaker	1	
180	Crsh4	Crash cymbal 4	2		256	JBell	Jingle bell	2	
181	Crsh5	Crash cymbal 5	2		257	BelTr	Bell tree	1	
182	Spls1	Splash cymbal 1	1		258	AnCow	Analog cowbell	1	
183	Spls2	Splash cymbal 2	2		259	AnCgH	Analog conga high	2	
184	Spls3	Splash cymbal 3	2		260	AnCgM	Analog conga mid	2	
185	Chns1	Chinese cymbal 1	2		261	AnCgL	Analog conga low	2	
186	Chns2	Chinese cymbal 2	2		262	AnMrc	Analog maracas	2	
187	OCymO	Orchestra cymbal open	1		263	AnClv	Analog claves	2	
188	OCymC	Orchestra cymbal close	1		264	Stick	Stick	1	
189	CrRol	Crash cymbal roll	1	Fixed	265	Click	Click (square wave)	2	
190	ChRol	Chinese cymbal roll	1	Fixed	266	HighQ	High Q	1	
191	RevrS	Reverse cymbal	2	Fixed	267	ScrH	Scratch high	1	
192	CymE1	Electronic cymbal 1	2		268	ScrL	Scratch low	1	
193	CymE2	Electronic cymbal 2	2		269	Fingr	Finger	2	
194	CymE3	Electronic cymbal 3	2		270	Taiko	Taiko	2	
195	AnCrs	Analog crash cymbal	1		271	Ethn1	Ethnic 1	2	
196	Gong1	Gong 1	2		272	Ethn2	Ethnic 2	2	
197	Gong2	Gong 2	2		273	Bot11	Bottle 1	2	
198	TDryH	Dry tom high	2		274	Bot12	Bottle 2	2	
199	TDryM	Dry tom mid	2		275	S.Can	Steel can	2	
200	TDryL	Dry tom low	2		276	TBell	Twinkle bell	2	
201	TDryF	Dry tom floor	2		277	WBell	Wind bell	2	
202	TLgtH	Light tom high	2		278	BgPip	Big pipe	2	
203	TLgtM	Light tom mid	2		279	Shot1	Gun shot 1	2	
204	TLgtL	Light tom low	2		280	Shot2	Gun shot 2	2	
205	TLgtF	Light tom floor	2		281	Bomb1	Bomb 1	2	
206	TRomH	Room tom high	2		282	Bomb2	Bomb 2	2	
207	TRomM	Room tom mid	2		283	War	War	2	
208	TRomL	Room tom low	2		284	Anim1	Animal	2	
209	TRomF	Room tom floor	2		285	Mnstr	Monster	2	
210	TPwrH	Power tom high	2		286	SFX1	SFX 1	2	
211	TPwrM	Power tom mid	2		287	SFX2	SFX 2	2	
212	TPwrL	Power tom low	2		288	SFX3	SFX 3	2	
213	TPwrF	Power tom floor	2		289	SFX4	SFX 4	2	
214	TJazH	Jazz tom high	1		290	SFX5	SFX 5	2	
215	TJazM	Jazz tom mid	1		291	SFX6	SFX 6	2	
216	TJazL	Jazz tom low	1		292	BFngr	Fingered bass	1	Fixed
217	TJazF	Jazz tom floor	1		293	BPick	Picked bass	2	Fixed
218	TBrSfH	Brush tom high	1		294	BFles	Fretless bass	1	Fixed
219	TBrSM	Brush tom mid	1		295	BS1p1	Slap bass 1	2	Fixed
220	TBrSL	Brush tom low	1		296	BS1p2	Slap bass 2	2	Fixed
221	TBrSF	Brush tom floor	1		297	BSyn1	Synthe bass 1	2	Fixed
222	TAn1	Analog tom 1	1		298	BSyn2	Synthe bass 2	2	Fixed
223	TAn2	Analog tom 2	2		299	BACO	Acoustic bass	1	Fixed

Note: Voices fixed to Note Driven cannot be changed to Trigger Driven. They always receive Note Off.

■ Troubleshooting

If you encounter one of the problems listed below, please check the possible causes and solutions before you assume that your RY20 is faulty.

Problem	Possible Causes and Solutions
No sound	Make sure the VOLUME control is turned up to a reasonable level. The VOLUME control affects the level of both the OUTPUT jacks and the PHONES jack.
	Check the levels set in the MIDI functions, Volume and Expression (see page 116).
	The level of the drum pad is set to zero (see page 86).
	The pattern or song that you selected is empty.
	The tracks of the selected pattern or song have been muted (see page 20).
	If you are using an external sound system, check the connections between the RY20 and the sound system. Look for possible connection failures or shorts.
	Make sure the volume control(s) on your external sound system is turned up to a reasonable level.
	Make certain that the RY20 is properly connected to the Yamaha AC adaptor that is included and that the power is turned ON.
Distorted sound	Bad connections and faulty audio cables can cause distorted sound. Make sure the cable plugs are clean and that all cable connections are secure.
	If your RY20 is connected to an external sound system, check that the RY20 VOLUME control is not turned up too high, thereby overloading the input to your sound system and causing distortion.
The pads produce sound, but the songs or patterns will not play	This problem is most likely caused by an improper MIDI Sync setting (see page 110). If you are not synchronizing the RY20 to an external MIDI clock signal, make sure the MIDI Sync is set to "INT" (internal clock).
	If you are synchronizing the RY20 to an external MIDI device and have set the MIDI Sync to "MIDI" (MIDI clock), make sure that the MIDI OUT connector of the external MIDI device is properly connected to the RY20 MIDI IN connector and that the external device is transmitting an appropriate MIDI clock signal to the RY20.
The RY20 does not respond to MIDI control	Check that the RY20 MIDI channels are set to match the channels of the controlling MIDI device. The RY20 has three MIDI channel settings – drum channel (page 111), bass channel (page 112), and program change channel (page 113). Make sure these parameters are set properly for the type of MIDI control you are attempting.
	Check your MIDI connections and cables carefully.

■ LCD Messages

The following is a list of messages that the RY20 will display if errors or other conditions have occurred.

PRESET	You have attempted to change a parameter in a preset pattern, song or drum kit.
MEMORY FULL	The RY20 memory is full or almost full and the specified operation cannot be performed. Delete unwanted songs to make more memory available.
SELECT TRACK	You have attempted to copy or clear a pattern without first selecting tracks. Select tracks and try the operation again.
PART EMPTY	You have attempted to delete a part in Song Record Mode that was already empty.
NOT EMPTY	You have attempted to change the meter or number of measures in a pattern which contains data. Clear the pattern and try again.
TS NOT MATCH	You have attempted to copy tracks to a pattern that has a time signature different from that of the source pattern.
BUFFER FULL	Too much MIDI data is being received by the RY20 at one time. Reduce the amount of data that is being sent to the RY20.
BATT LOW	The built-in memory back-up lithium battery is running low. Take your RY20 to an authorized Yamaha Service Center to have the battery replaced. DO NOT ATTEMPT TO REPLACE THE BACK-UP BATTERY YOURSELF.
DATA ERROR	Unrecognizable MIDI data was received by the RY20. Make sure that all bulk data sent to the RY20 conforms with the RY20 MIDI specifications.
TIME OVER	If a MIDI bulk data transfer fails to complete within a certain period of time, this error message will appear on the display.
MIDI ERR1	The RY20 detected a MIDI overrun error in the incoming data. Check all relevant settings, then try sending the data again. If the error persists, check your MIDI cables and connections.
MIDI ERR2	The RY20 detected a MIDI framing error in the incoming data. Check all relevant settings, then try sending the data again. If the error persists, check your MIDI cables and connections.
PLEASE WAIT	The RY20 is busy performing the requested operation, for example, preparing to record, rearranging its memory to complete a recording, etc.
END	The RY20 has just completed the requested operation, for example, finishing a recording, copying data, sending or receiving MIDI bulk data, etc.
BULK SEND	The RY20 is transmitting MIDI bulk data to an external device.
RECEIV BULK	The RY20 is receiving MIDI bulk data from a MIDI data storage device.

■ Specifications

Tone Generator	Type	AWM (Advanced Wave Memory)	
	Polyphony	28-note	
	Voices	300	
Digital Signal Processor	Type	6 Reverbs, 4 Delays	
	Parameters	On/Bypass; Send Level, Return Level, Reverb Time, Feedback Gain, Delay Time	
Sequencer	Patterns	Patterns	50 Presets, 50 Users, 50 Combinations
		Sections	Intro, Main A, Main B, Fill AB, Fill BA, Ending
		Tracks	Bass Drum, Snare Drum, Hi-hat, Others
		Tempo	40 - 250
		Note Resolution	96 Clocks per Quarter Note
		Pattern Play	Initial Tempo, Swing, Groove (14 types), Velocity Modify, Clear, Copy, Name
		Pattern Record	Quantize, Time Signature, Measure, Click, Delete; Record Data (Level, Pad, Gate Time)
	Songs	Songs	50, Demo
		Song Play	Initial Tempo, Repeat, Chain, Clear, Copy, Name
Song Record		Part, Part Delete, Part Insert, Click; Record Data (Pattern, Section, Fill In Start Position)	
Drum Kit	Drum Kits	20 Presets, 20 Users	
	Parameters	Assign, Level, Pan, Pitch, Decay, Sensitivities (Level, Pitch, Decay, Balance), Voice Polyphony, Alternate Group, Trigger/Note Driven, Pad Sensitivity, Chase, Copy, Name	
	Pad Banks	5 Drum Pad Banks (60 Pads), 1 Bass Pad Bank (60 Pads=5 Octaves)	
	Drum Pads	12 velocity Sensitive Pads	
MIDI	Parameters	Sync., Drum/Bass Channels, Program Change, Note Number (4 Note Tables), Drum/Bass Volumes, Drum/Bass Expressions, Bulk Send	
Controls	Power, Volume, Jog/Shuttle Dials, Mode Keys, Page+/Page-, Enter, +1/-1, ◀/▶ Cursors, Record, Stop, Play, Top, Backward, Forward, Track Select/Mute, Section		
Indicators	Multi-function LCD (66 × 42mm), Play LED, Record LED		
Connectors	Headphones, Output (L/Mono and R), MIDI In/Out, DC In		
Included Accessory	PA-3 AC Adaptor (except in the UK)		
Electrical Characteristics	Power Consumption 3.5 W		
	Output Impedance - Line: 1kΩ; Headphones: 47Ω		
Dimensions (W × D × H)	240 × 176 × 48 mm (9 1/2" × 6 7/8" × 1 7/8")		
Weight	700g (1lbs 9oz)		

MIDI Data Format

1. MIDI Receive

1.1. Reception Data and Conditions

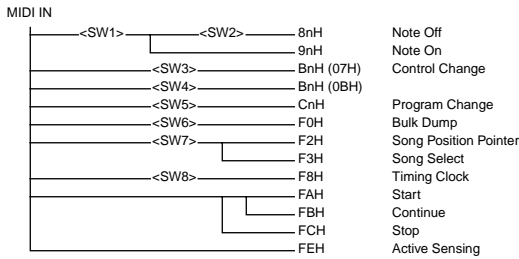

Note: <SW1> Drum voice or bass voice Send/Receive channel.
 <SW2> Ignored if the pad is not set to Note Driven.
 <SW3> Main volume control message.
 <SW4> Expression control message.
 <SW5> Program change channel.
 <SW6> Bulk dump is only possible when the RY20 is in Pattern or Song Select Mode.
 <SW7> Only received in Song Play Mode.
 <SW8> MIDI Sync is active.

1.2. Reception Data

1) System Real-time Messages

Timing Clock	11111000	(F8H)
Start	11111010	(FAH)
Continue	11111011	(FBH)
Stop	11111100	(FCH)
Active Sensing	11111110	(FEH)

2) Channel Messages

Note Off

Status	1001nnnn	(9nH)	n = 0-15 Voice Channel Number
Note Number	1000nnnn	(8nH)	k = 0 (C-2)-127(G8)
Velocity	0vvvvvvv		

Note: Note Off messages are only received by voices that have Note Driven set.
 The bass voice will not receive Note Off messages if the drum and bass send/receive channels are set to the same channel number.
 The bass voice will respond to Note Numbers throughout a five octave range.

Note On

Status	1001nnnn	(9nH)	n = 0-15 Voice Channel Number
Note Number	0kkkkkkk		k = 0 (C-2)-127(G8)
Velocity	0vvvvvvv		Note On v = 1-127

Note: The bass voice will not sound if the drum and bass send/receive channels are set to the same channel number.
 The bass voice will respond to Note Numbers throughout a five octave range.

Control Change

Status	1011nnnn	(BnH)	n = 0-15 Voice Channel Number
Control Number	00001110	(07H)	Main Volume
Control Value	00001011	(0BH)	Expression
Control Value	0vvvvvvv		v = 0-127

Program Change

Status	1100nnnn	(CnH)	n = 0-15 Voice Channel Number
Program Number	0ppppppp		p = 0-127

Note: When a Program Change message is received, the RY20 changes to the drum kit corresponding to the received program number.

3) System Common Messages

Song Position Pointer

Status	11110010	(F2H)
Value	01111111	
Value	0hhhhhhh	
		l = 0-127 Least Significant
		h = 0-127 Most Significant

Note: Only received in Song Play Mode.

Song Select

Status	11110011	(F3H)
Song Number	00ssssss	s = 0-49

Note: Only received in Song Play Mode.

4) System Exclusive Messages

Bulk Dump

0	11110000	(F0H)	
1	01000011	(43H)	
2	00000000	(00H)	Device Number (00H fixed)
3	01111110	(7EH)	
4	00000100	(04H)	Byte Count (MSB)
5	00001010	(0AH)	Byte Count (LSB)
6	01001100	(4CH)	ASCII "L"
7	01001101	(4DH)	ASCII "M"
8	00100000	(20H)	ASCII "*"
9	00100000	(20H)	ASCII "*"
10	00110000	(30H)	ASCII "0"
11	00110001	(31H)	ASCII "1"
12	00110101	(35H)	ASCII "5"
13	00110011	(33H)	ASCII "3"
14	01000001	(41H)	ASCII "A"
15	01001100	(4CH)	ASCII "L"
16	0ddddd		Data
17	0sssssss		Checksum
18	11110111	(F7H)	EOX

Note: The RY20 can only receive bulk data while it is in Pattern or Song Select Mode. A block consists of the Byte Count, the data bytes, and the Checksum. A number of blocks are repeatedly transferred. The number of blocks transmitted or received depends on the quantity of pattern and song data.
 One byte of data is divided into 4bits MSB and 4bits LSB. It is then converted to ASCII data for transfer.
 A bulk dump consists of the following data:

- System data
- MIDI set-up data
- Drum kit data
- Pattern data
- Song data

2. MIDI Transmit

2.1. Transmission Data and Conditions

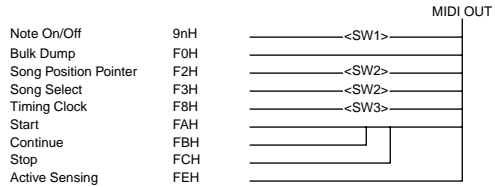

Note: <SW1> Drum voice or bass voice Send/Receive channel.
 <SW2> Only sent in Song Play Mode.
 <SW3> Transmits the Internal Sync.

2.2. Transmission Data

1) System Real-time Messages

Timing Clock	11111000	(F8H)
Start	11111010	(FAH)
Continue	11111011	(FBH)
Stop	11111100	(FCH)
Active Sensing	11111110	(FEH)

2) Channel Messages

Note On/Off

Status	1001nnnn	(9nH)	n = 0-15 Voice Channel Number
Note Number	0kkkkkkk		k = 0 (C-2)-127(G8)
Velocity	0vvvvvvv		Note On v = 1-127
Velocity	00000000		Note Off

3) System Common Messages

Song Position Pointer

Status	11110010	(F2H)
Value	01111111	
Value	0hhhhhhh	
		l = 0-127 Least Significant
		h = 0-127 Most Significant

Note: Only active in Song Play Mode. A "part" or a "measure" may be transmitted.

Song Select

Status	11110011	(F3H)
Song Number	00ssssss	s = 0-49

Note: Only transmitted in Song Play Mode. The song number is transmitted when selected.

4) System Exclusive Messages

Bulk Dump

The data is the same as that for reception. The RY20 can only transmit bulk data when it is in Pattern or Song Select Mode.

Function ...	Transmitted	Recognized	Remarks
Basic Default	1 - 16	1 - 16	
Channel Changed	1 - 16	1 - 16	
Mode Default	3	3	
Messages altered	x *****	x x	
Note Number : True voice	0-127 *****	0-127/5octave*1 x	
Velocity Note ON	<input type="radio"/> 9nH,v=1-127	<input type="radio"/> 9nH,v=1-127	
Note OFF	<input checked="" type="radio"/> 9nH,v=0	<input type="radio"/> 8(9)nH,v=0*2	
After Key's	<input checked="" type="radio"/> x	<input checked="" type="radio"/> x	
Touch Ch's	<input checked="" type="radio"/> x	<input checked="" type="radio"/> x	
Pitch Bender	<input checked="" type="radio"/> x	<input checked="" type="radio"/> x	
Control Change	7 <input checked="" type="radio"/> x 11 <input checked="" type="radio"/> x	<input type="radio"/> o <input type="radio"/> o	volume expression
Prog Change : True #	<input checked="" type="radio"/> x *****	<input type="radio"/> o 0 - 127 <input checked="" type="radio"/> x	drum kit select
System Exclusive	<input type="radio"/> o	<input type="radio"/> o	song data etc
: Song Pos.	<input type="radio"/> o	<input type="radio"/> o	
common : Song Sel.	<input type="radio"/> o 0 - 49	<input type="radio"/> o 0 - 49	
: Tune	<input checked="" type="radio"/> x	<input checked="" type="radio"/> x	
System :Clock	<input type="radio"/> o	<input type="radio"/> o	
Real Time :Commands	<input type="radio"/> o	<input type="radio"/> o	
Aux :Local ON/OFF	<input checked="" type="radio"/> x	<input checked="" type="radio"/> x	
:All Notes OFF	<input checked="" type="radio"/> x	<input checked="" type="radio"/> x	
Mes- :Active Sense	<input type="radio"/> o	<input type="radio"/> o	
sages:Reset	<input checked="" type="radio"/> x	<input checked="" type="radio"/> x	
<p>Note: *1 = Drum voice=a different voice sounds by each note. Bass voice=single voice sounds over a five-octave range. (C-2~B2 ~ G#3~G8)</p> <p>*2 = Recognize if pad is note-driven.</p>			

Mode 1 : OMNI ON, POLY
Mode 3 : OMNI OFF, POLY

Mode 2 : OMNI ON, MONO
Mode 4 : OMNI OFF, MONO

o : Yes
 x : No

Index

+1 and -1 buttons 5

A

AC adaptor 9
 ALTER (Alternate group) 96
 ASSIGN 85
 Audition button 7, 32

B

Backward button [◀] 6, 32, 42, 65, 74
 BASS (Pad bank) 26, 84
 BASS CH (Bass channel) 112
 Beat indicator [▼] 41
 Bulk Dump 118
 BYPAS (Bypass) 102

C

Chain 76
 CHASE 99
 CLEAR SURE? 55, 77
 Clear/Delete button 6, 42, 55, 69, 77
 CLICK 47, 72
 COMB (Combination) 38
 COPY SURE? 58, 79, 100
 Copy/Insert button 6, 58, 70, 79
 COUNT 35, 67
 Cursor buttons [◀▶] 5, 42, 74

D

D. TIME (Delay time) 108
 DC In jack 8, 9
 DECAY 89
 DEL (Delete) 42, 69
 Delay 103
 DEMO 12
 DRUM (Pad bank) 23, 84
 DRUM CH (Drum channel) 111
 Drum Kit button 4, 22, 83
 Drum Kit mode 22, 83
 Drum pads 7, 22, 31

E

Effect button 4, 102
 Effect mode 102
 EMPTY 16
 Enter button 5, 43, 56, 59, 65, 70, 71, 78, 79, 100
 EXPRES DR/BS (Expression Drum/Bass) 117

F

F. GAIN (Feedback gain) 107
 FACTRY SET (Factory set) 120
 Forward button [▶] 6, 32, 41, 65, 74

G

GATE 45
 Groove 50

I

INS (Insert) 70

J

Jog/Shuttle dial 3

L

LCD Display 2
 LEVEL 43, 47, 53, 72, 86

M

MEAS | BEAT | CLOCK 40
 MEASURE 18, 47, 64
 METER 46
 MIDI button 4, 110
 MIDI connectors 8, 10
 MIDI mode 110
 MUTE 20

N

NAME 60, 81, 101
 NEXT 16
 NOTE (Note driven) 97
 Note indicator [■] 41
 Note number 115
 NT TBL (Note table) 114

O

OCT (Octave) 26, 84
 Output jacks 8, 10

P

PAD 43
 Pad Bank button 4, 23, 84
 Pad Bank mode 23, 84
 PADBNK (Pad Bank) 23, 84
 PADSNS (Pad sensitivity) 98
 Page+ and Page- buttons 4
 PAN 87
 PART 64, 69, 70
 Pattern button 3, 14, 29
 Pattern mode 14
 Pattern real-time record mode 35
 Pattern step record mode 29
 Phones jack 8, 9
 PITCH 88
 Play button [▶] 5, 14, 35, 67, 73
 POLY (Polyphony) 95
 Position indicator [▼] 41
 Power switch 8, 11
 PRGRM CH (Program channel) 113

Q

QUANTIZE 44, 48, 53, 72

R

R. TIME (Reverb time) 106
 Record button [●] 5, 30, 38, 63
 Repeat 75
 Reverb 103
 RTNLVL (Return level) 105

S

Section button 7, 17
 SENS BAL (Balance Sensitivity) 93
 SENS DCY (Decay sensitivity) 92
 SENS LVL (Level sensitivity) 90
 SENS PCH (Pitch Sensitivity) 91
 SNDLVL (Send level) 104
 Song button 3, 73
 Song mode 12, 73
 Song real-time record mode 67
 Song step record mode 62
 Stop button [■] 5, 15, 73
 SURE? 69, 70
 Swing 49
 SYNC 110

T

Tempo button 3, 19, 44
 Time signature 46
 TIMING 53
 Top button [◀] 6, 42, 65, 73
 Total reset 120
 Track Select/Mute buttons 3, 20, 38, 54, 56, 58
 TRIG (Trigger driven) 97
 TYPE 103

V

VELCTY (Velocity) 54
 Voice level indicators 15, 37
 Volume control 2, 14
 VOLUME DR/BS (Volume Drum/Bass) 116

For details of products, please contact your nearest Yamaha or the authorized distributor listed below.

Pour plus de détails sur les produits, veuillez-vous adresser à Yamaha ou au distributeur le plus proche de vous figurant dans la liste suivante.

Die Einzelheiten zu Produkten sind bei Ihrer unten aufgeführten Niederlassung und bei Yamaha Vertragshändlern in den jeweiligen Bestimmungsländern erhältlich.

Para detalles sobre productos, contacte su tienda Yamaha más cercana o el distribuidor autorizado que se lista debajo.

NORTH AMERICA

CANADA

Yamaha Canada Music Ltd.
135 Milner Avenue, Scarborough, Ontario,
M1S 3R1, Canada
Tel: 416-298-1311

U.S.A.

Yamaha Corporation of America
6600 Orangethorpe Ave., Buena Park, Calif.
90620, U.S.A.
Tel: 714-522-9011

CENTRAL & SOUTH AMERICA

MEXICO

**Yamaha de Mexico S.A. De C.V.,
Departamento de ventas**
Javier Rojo Gomez No.1149, Col. Gpe Del
Moral, Deleg. Iztapalapa, 09300 Mexico, D.F.
Tel: 686-00-33

BRAZIL

Yamaha Musical do Brasil LTDA.
Av. Rebouças 2636, São Paulo, Brasil
Tel: 011-853-1377

ARGENTINA

Yamaha Music Argentina S.A.
Viamonte 1145 Piso2-B 1053,
Buenos Aires, Argentina
Tel: 1-371-7021

PANAMA AND OTHER LATIN AMERICAN COUNTRIES/ CARIBBEAN COUNTRIES

Yamaha de Panama S.A.
Torre Banco General, Piso 7, Urbanización
Marbella,
Calle 47 y Aquilino de la Guardia,
Ciudad de Panamá, Panamá
Tel: 507-269-5311

EUROPE

THE UNITED KINGDOM

Yamaha-Kemble Music (U.K.) Ltd.
Sherbourne Drive, Tilbrook, Milton Keynes,
MK7 8BL, England
Tel: 01908-366700

IRELAND

Danfay Ltd.
61D, Sallynoggin Road, Dun Laoghaire, Co.
Dublin
Tel: 01-2859177

GERMANY/SWITZERLAND

Yamaha Europa GmbH.
Siemensstraße 22-34, 25462 Rellingen,
F.R. of Germany
Tel: 04101-3030

AUSTRIA

Yamaha Music Austria
Schleiergasse 20, A-1100 Wien Austria
Tel: 01-60203900

THE NETHERLANDS

Yamaha Music Nederland
Kanaalweg 18G, 3526KL, Utrecht, The Netherlands
Tel: 030-2828411

BELGIUM

Yamaha Music Belgium
Keiweg Imperiastraat 8, 1930 Zaventem, Belgium
Tel: 02-7258220

FRANCE

**Yamaha Musique France,
Division Professionnelle**
BP 70-77312 Marne-la-Vallée Cedex 2, France
Tel: 01-64-61-4000

ITALY

**Yamaha Musica Italia S.P.A.,
Combo Division**
Viale Italia 88, 20020 Lainate (Milano), Italy
Tel: 02-935-771

SPAIN/PORTUGAL

Yamaha-Hazen Electronica Musical, S.A.
Jorge Juan 30, 28001, Madrid, Spain
Tel: 91-577-7270

GREECE

Phillipe Nakas S.A.
Navarinou Street 13, P.Code 10680, Athens,
Greece
Tel: 01-364-7111

SWEDEN

Yamaha Scandinavia AB
J. A. Wettergrens Gata 1
Box 30053
S-400 43 Göteborg, Sweden
Tel: 031 89 34 00

DENMARK

YS Copenhagen Liaison Office
Generatorvej 8B
DK-2730 Herlev, Denmark
Tel: 44 92 49 00

FINLAND

F-Musikki Oy
Kluuvikatu 6, P.O. Box 260,
SF-00101 Helsinki, Finland
Tel: 09 618511

NORWAY

Norsk filial av Yamaha Scandinavia AB
Grini Næringspark 1
N-1345 Østerås, Norway
Tel: 67 16 77 70

ICELAND

Skifan HF
Skeifan 17 P.O. Box 8120
IS-128 Reykjavik, Iceland
Tel: 525 5000

OTHER EUROPEAN COUNTRIES

Yamaha Europa GmbH.
Siemensstraße 22-34, 25462 Rellingen, F.R. of
Germany
Tel: 04101-3030

AFRICA

**Yamaha Corporation,
International Marketing Division**
Nakazawa-cho 10-1, Hamamatsu, Japan 430-8650
Tel: 053-460-2312

MIDDLE EAST

TURKEY/CYPRUS

Yamaha Europa GmbH.
Siemensstraße 22-34, 25462 Rellingen,
F.R. of Germany
Tel: 04101-3030

OTHER COUNTRIES

Yamaha Music Gulf FZE
LB21-128 Jebel Ali Freezone
P.O.Box 17328, Dubai, U.A.E.
Tel: 971-4-81-5868

ASIA

HONG KONG

Tom Lee Music Co., Ltd.
11/F., Silvercord Tower 1, 30 Canton Road,
Tsimshatsui, Kowloon, Hong Kong
Tel: 2737-7688

INDONESIA

**PT. Yamaha Music Indonesia (Distributor)
PT. Nusantik**
Gedung Yamaha Music Center, Jalan Jend. Gatot
Subroto Kav. 4, Jakarta 12930, Indonesia
Tel: 21-520-2577

KOREA

Cosmos Corporation
1461-9, Seocho Dong, Seocho Gu, Seoul, Korea
Tel: 02-3486-0011

MALAYSIA

Yamaha Music Malaysia, Sdn., Bhd.
Lot 8, Jalan Perbandaran, 47301 Kelana Jaya,
Petaling Jaya, Selangor, Malaysia
Tel: 3-703-0900

PHILIPPINES

Yupango Music Corporation
339 Gil J. Puyat Avenue, P.O. Box 885 MCPO,
Makati, Metro Manila, Philippines
Tel: 819-7551

SINGAPORE

Yamaha Music Asia Pte., Ltd.
11 Ubi Road #06-00, Meiban Industrial Building,
Singapore
Tel: 65-747-4374

TAIWAN

Yamaha KHS Music Co., Ltd.
10F, 150, Tun-Hwa Northroad,
Taipei, Taiwan, R.O.C.
Tel: 02-2713-8999

THAILAND

Siam Music Yamaha Co., Ltd.
121/60-61 RS Tower 17th Floor,
Ratchadaphisek RD., Dindaeng,
Bangkok 10320, Thailand
Tel: 02-641-2951

THE PEOPLE'S REPUBLIC OF CHINA AND OTHER ASIAN COUNTRIES

**Yamaha Corporation,
International Marketing Division**
Nakazawa-cho 10-1, Hamamatsu, Japan 430-8650
Tel: 053-460-2317

OCEANIA

AUSTRALIA

Yamaha Music Australia Pty. Ltd.
17-33 Market Street, South Melbourne, Vic. 3205,
Australia
Tel: 3-699-2388

NEW ZEALAND

Music Houses of N.Z. Ltd.
146/148 Captain Springs Road, Te Papapa,
Auckland, New Zealand
Tel: 9-634-0099

COUNTRIES AND TRUST TERRITORIES IN PACIFIC OCEAN

**Yamaha Corporation,
International Marketing Division**
Nakazawa-cho 10-1, Hamamatsu, Japan 430-8650
Tel: 053-460-2317

HEAD OFFICE Yamaha Corporation, Electronic Musical Instrument Division
Nakazawa-cho 10-1, Hamamatsu, Japan 430-8650
Tel: 053-460-2445

YAMAHA
YAMAHA CORPORATION